



Load and Motor Switch / Control Switch

Series 8006/4



Contents

1	General Information	3
1.1	Manufacturer	3
1.2	Information Regarding the Operating Instructions	3
1.3	Further Documents	3
1.4	Conformity with Standards and Regulations	3
2	Explanation of the Symbols	3
2.1	Symbols in these Operating Instructions	3
2.2	Warning Notes	4
2.3	Symbols on the Device or in the Circuit Diagrams	4
3	Safety Notes	5
3.1	Operating Instructions Storage	5
3.2	Safe Use	5
3.3	Modifications and Alterations	5
4	Function and Device Design	5
4.1	Function	5
5	Technical data	6
6	Transport and Storage	8
7	Mounting and Installation	9
7.1	Dimensions / Fastening Dimensions	9
7.2	Mounting / Dismounting, Operating Position	10
7.3	Installation	11
8	Commissioning	12
9	Operation	12
10	Maintenance and Repair	12
10.1	Maintenance	12
10.2	Maintenance	12
10.3	Repair	13
10.4	Returning the Device	13
11	Cleaning	13
12	Disposal	13
13	Accessories and Spare Parts	13

1 General Information

1.1 Manufacturer

R. STAHL Schaltgeräte GmbH
Am Bahnhof 30
74638 Waldenburg
Germany

Phone: +49 7942 943-0

Fax: +49 7942 943-4333

Internet: www.stahl-ex.com

1.2 Information Regarding the Operating Instructions

ID-No.: 224910 / 8006609300

Publication Code: 2014-05-06-IOM00-III-en-03

Hardware version: n/a

Software version: n/a

The original instructions are the English edition.
They are legally binding in all legal affairs.

1.3 Further Documents

- Data sheet 8006/4





For further languages, see www.stahl-ex.com.

1.4 Conformity with Standards and Regulations

See certificates and EC Declaration of Conformity: www.stahl-ex.com.

2 Explanation of the Symbols



2.1 Symbols in these Operating Instructions

Symbol	Meaning
	Tips and recommendations on the use of the device
	General danger
	Danger due to explosive atmosphere
	Danger due to energised parts



2.2 Warning Notes

Warning notes must be observed under all circumstances, in order to minimize the risk due to construction and operation. The warning notes have the following structure:

- Signalling word: DANGER, WARNING, CAUTION, NOTICE
- Type and source of danger/damage
- Consequences of danger
- Taking countermeasures to avoid the danger/damage

	DANGER
	Danger for persons Non-compliance with the instruction results in severe or fatal injuries to persons.
	WARNING
	Danger for persons Non-compliance with the instruction can result in severe or fatal injuries to persons.
	CAUTION
	Danger for persons Non-compliance with the instruction can result in minor or light injuries to persons.
NOTICE	
Avoiding material damage Non-compliance with the instruction can result in material damage to the device and/or its environment.	

2.3 Symbols on the Device or in the Circuit Diagrams

Symbol	Meaning
NB 0158 <small>16338E00</small>	NB marking according to DEKRA EXAM GmbH certification authority.
 <small>02198E00</small>	According to marking, device approved for hazardous areas.
 <small>15649E00</small>	Input
 <small>15648E00</small>	Output

3 Safety Notes

3.1 Operating Instructions Storage

- Read the operating instructions carefully and store them at the mounting location of the device.
- Observe applicable documents and operating instructions of the devices to be connected.

3.2 Safe Use

- Read and observe the safety notes in these operating instructions!
- Use the device in accordance with its intended and approved purpose only.
- We cannot be held liable for damage caused by incorrect or unauthorized use or by non-compliance with these operating instructions.
- Before installation and commissioning, make sure that the device is not damaged.
- Work on the device (installation, maintenance, overhaul, repair) may only be carried out by appropriately authorized and trained personnel.
- During installation and operation observe the information (characteristic values and rated operating conditions) on the rating, data and information plates located on the device.
- Always consult with R. STAHL Schaltgeräte GmbH in case of operating conditions which deviate from the technical data.
- Replace the switch after each short circuit in the main circuit, since with hermetically sealed equipment the state of the switching contacts cannot be checked.

3.3 Modifications and Alterations

	WARNING
	<p>Danger due to modifications and alterations to the device! Explosion protection is impaired!</p> <ul style="list-style-type: none"> • Do not modify or change the device. • No liability or warranty for damage resulting from modifications and alterations.

4 Function and Device Design

	WARNING
	<p>Danger due to improper use! Explosion protection is impaired!</p> <ul style="list-style-type: none"> • The device may only be used according to the operating conditions described in these operating instructions. • Use the device in hazardous areas only according to these operating instructions.

4.1 Function

The Load and Motor Switch 8006 is used for switching electric and electronic components that are used for controlling, switching and monitoring electric machines and installations.

5 Technical data

Explosion Protection

USA (UL)/Canada (UL)

Gas



US: Class I, Zone 1, AEx d e IIC T6 ... T5 (Class I, Div. 2, Groups ABCD)
 C: Class I, Zone 1, Ex d e IIC T6 ... T5 Gb (Class I, Div. 2 per CEC J18-150)

T6 (Ta = -50 ... +50 °C)
 T5 (Ta = -50 ... +65 °C)
 T4 (Ta = -50 ... +70 °C)

Certifications and certificates

Certificates

IECEX, ATEX

Technical Data

Electrical data

Rated insulation voltage	max. 690 V AC																		
Rated operational voltage	max. 600 V AC / 240 V DC min. 24 V AC / DC																		
Rated impulse withstand voltage	6 kV																		
Rated operational current	max. 25 A (load and motor switch) max. 10 A (control switch) min. 100 mA (recommended for contact safety: min. one switching operation per week)																		
Switching capacity	AC	DC																	
	600 V, 20 A 120 V ... 480 V, 25 A	240 V, 25 A ³⁾ 125 V, 25 A ²⁾ 62.5 V, 25 A ¹⁾																	
Motor switching capacity	600 V, 15 HP 480 V, 15 HP 240 V, 7.5 HP 208 V, 7.5 HP	240 V, 5 HP 125 V, 3 HP																	
			1) 1 contact 2) 2 contacts in series 3) 3 contacts in series																
		Single Phase <table border="0"> <tr> <td>Voltage</td> <td>227 V</td> <td>240 V</td> <td>208 V</td> <td>120 V</td> </tr> <tr> <td>Current</td> <td>25 A</td> <td>25 A</td> <td>25 A</td> <td>25 A</td> </tr> <tr> <td>Horse Power</td> <td>5</td> <td>3</td> <td>3</td> <td>2</td> </tr> </table>			Voltage	227 V	240 V	208 V	120 V	Current	25 A	25 A	25 A	25 A	Horse Power	5	3	3	2
Voltage	227 V	240 V	208 V	120 V															
Current	25 A	25 A	25 A	25 A															
Horse Power	5	3	3	2															
Short circuit protection	Control Switch Ratings (UL 508): A600 (AC) N300 (DC) ≤ 40 A Class J																		



Explosion Protection

USA (FM)/Canada (FM)

Gas



3044997

US: Class I, Zone 1, AEx d e IIC T6 ... T5 (Class I, Div. 2, Groups ABCD)
 C: Class I, Zone 1, Ex d e IIC T6 ... T5 Gb (Class I, Div. 2 per CEC J18-150)

T6 (Ta = -50 ... +40 °C)

T5 (Ta = -50 ... +55 °C)

Technical Data

Electrical data

Rated insulation voltage	max. 690 V AC				
Rated operational voltage	max. 600 V AC / 125 V DC min. 24 V AC / DC				
Rated impulse withstand voltage	6 kV				
Rated operational current	T6 max. 40°C up to 4 pole: max. 25 A; Field wiring. Use 75 °C copper conductors. up to 8 pole: max. 15 A; Field wiring. Use 75 °C copper conductors. up to 12 pole: max. 10 A; Field wiring. Use 75 °C copper conductors. T5 max. 55°C up to 4 pole: max. 25 A; Factory wiring. Use 90 °C copper conductors. up to 8 pole: max. 15 A; Factory wiring. Use 90 °C copper conductors. up to 12 pole: max. 10 A; Factory wiring. Use 90 °C copper conductors.				
Switching capacity	max. 25 A (load and motor switch) max. 10 A (control switch) min. 100 mA (recommended for contact safety: min. one switching operation per week)				
	AC	DC			
	600 V, 20 A	125 V, 25 A ²⁾			
	120 V ... 480 V, 25 A	62.5 V, 25 A ¹⁾			
		¹⁾ 2 contacts in series ²⁾ 3 contacts in series			
Motor switching capacity	600 V, 15 HP	125 V, 3 HP			
	480 V, 15 HP				
	240 V, 7.5 HP				
	208 V, 7.5 HP				
		Single Phase			
	Voltage	227 V	240 V	208 V	120 V
	Current	25 A	25 A	25 A	25 A
	Horse Power	5	3	3	2
Short circuit protection	Control Switch Ratings (UL 508): A600 (AC) N300 (DC) ≤ 40 A Class J				



Technical Data

Electrical data

Short-circuit strength 20 kA

Contacts max. 12 pole / 6 switching levels *)

*) The switches have two switching chambers per level. Individual switching levels with 1 or 2 contacts each to form a unit provide an optimal solution for individual applications. The contact chambers are being operated by the ratched wheels in a staggered fashion, thus enabling all around switching without interference.

Service life mechanical: 200,000 operating cycles
electric: 20,000 operating cycles

Mechanical data

Material

Enclosure Epoxy resin

Contacts Silver-tin oxide, silver-tin oxide gold plated

For further technical data, see www.stahl-ex.com.

6 Transport and Storage

- Transport and store the device only in the original packaging.
- Store the device in a dry place (no condensation) and vibration-free.
- Do not drop the device.

7 Mounting and Installation

7.1 Dimensions / Fastening Dimensions

EN

Dimensional Drawings (All Dimensions mm [inches]) – Subject to Alterations

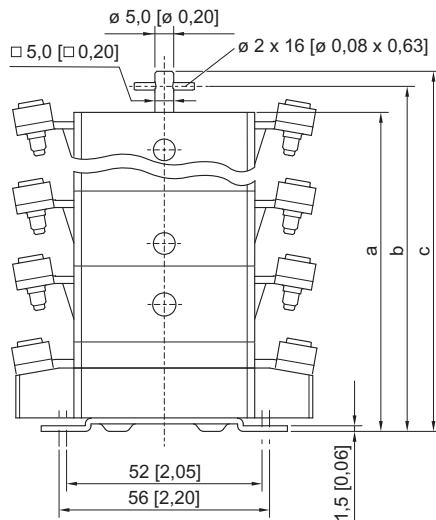

Switching chamber levels	Dimensions (mm) [inches]		
	a	b	c
1	44 [1.73]	52 [2.05]	56 [2.20]
2	64 [2.52]	72 [2.83]	76 [2.99]
3	84 [3.31]	92 [3.62]	96 [3.78]
4	105 [4.13]	112 [4.41]	116 [4.57]
5	125 [4.92]	132 [5.20]	136 [5.35]
6	145 [5.71]	152 [5.98]	156 [6.14]

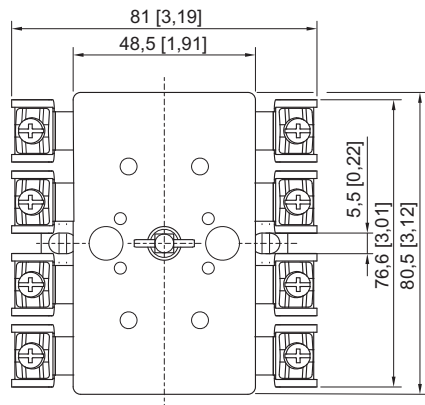

14289E00

Load and motor switch / control switch 25 A
Series 8006/4

EN

7.2 Mounting / Dismounting, Operating Position

EN

	WARNING
	<p>Danger due to live components! Risk of severe injuries!</p> <ul style="list-style-type: none"> • A minimum distance of 12.7 mm or 1/2 inch has to be kept between live parts and further components (at 600 V AC).
i	When mounting the component, ensure presence of a flat surface.
i	The operating position is optional.

Mounting the covers

IP20 cover:

Engage the IP20 covers (1) in the contact. Insert the designation plate (4) in the groove of the IP20 covers (1).

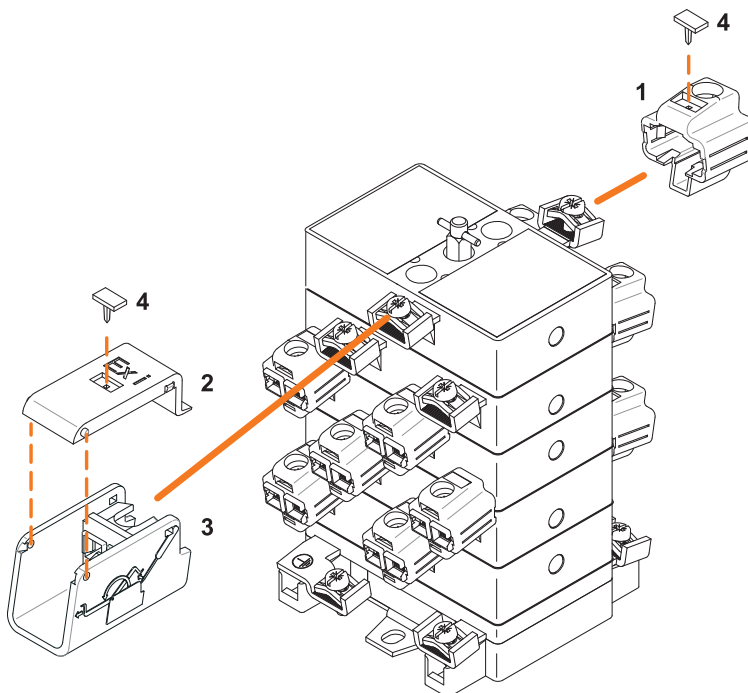

Ex i cover:

Engage the Ex i cover (3) in the contact. Engage the Ex i lid (2) in the Ex i cover (3). Insert the designation plate (4) in the groove of the Ex i lid (2).



15088E00

7.3 Installation

	WARNING
	<p>Danger due to live components! Risk of severe injuries!</p> <ul style="list-style-type: none"> • All connections and wiring must be disconnected from the power supply. • Secure the connections against unauthorized switching.
	WARNING
	<p>Install the device in an enclosure! Explosion protection is impaired !</p> <ul style="list-style-type: none"> • The device must be installed in an enclosure that fulfills the requirements of a recognized type of protection according to IEC/EN 60079-0.
	WARNING
	<p>Observe clearance and creepage distances! Explosion protection is impaired !</p> <ul style="list-style-type: none"> • During installation of the devices in an enclosure of the protection type increased safety "e" according to IEC/EN 60079-7 and UL 508, the clearance and creepage distances must be adhered to.

Electrical Connection

- The information given in chapter "Technical Data" must be observed.
- The conductor connection must be made with particular care.
- The conductor insulation must reach to the clamping points.
- Do not damage the conductor (nicking) when removing the insulation.
- Select suitable cables to be used and appropriate way of installing them to ensure that the maximum permitted conductor temperatures and the maximum permitted surface temperature are not exceeded.



14288E00

<p>Connection type</p> <p>Connection cross-section</p> <p style="padding-left: 20px;">solid / finely-stranded</p> <p>Tightening torque</p>	<p>Terminals</p> <p>14 AWG to 10 AWG (2.5 ... 6.0 mm²)</p> <p>One or two conductors can be installed to a connection terminal. In case of solid conductors, both conductors must have the same cross-section and must be made of the same material.</p> <p>The conductors can be connected without previous measures.</p> <p>17.7 in-lbs (2 Nm)</p>
--	--

	<p>If core end sleeves are used, they must be attached using a suitable tool.</p>
---	---

8 Commissioning

	WARNING
	<p>Check the device before commissioning! Explosion protection is impaired!</p> <ul style="list-style-type: none"> • Observe the inspection requirements in the current national regulations before commissioning in order to maintain the explosion protection. • Check the device for proper installation and function before commissioning.

Before commissioning, ensure the following:

- Check the mounting and installation.
- Inspect enclosure for damage.
- If necessary, remove foreign objects.
- If necessary, clean the connection chamber.
- Check whether all screws and nuts have been tightened firmly.
- Check the tightening torques.

9 Operation

The switch is driven via an axis, thus actuating the contacts.



10 Maintenance and Repair

	WARNING
	<p>Unauthorized work being performed on the device! Risk of injuries and material damage!</p> <ul style="list-style-type: none"> • Work performed on the device must only be carried out by appropriately authorized and trained personnel.

10.1 Maintenance

- Consult the relevant national regulations to determine the type and extent of inspections.
- Adapt inspection intervals to the operating conditions.

10.2 Maintenance

	WARNING
	<p>Danger due to live components! Risk of severe injuries!</p> <ul style="list-style-type: none"> • All connections and wiring must be disconnected from the power supply. • Secure the connections against unauthorized switching.
	<p>Observe the relevant national regulations in the country of use.</p>

10.3 Repair

	DANGER
	<p>Danger due to improper maintenance/repair! Explosion protection is impaired!</p> <ul style="list-style-type: none"> • Repair work on the device must be performed only by R. STAHL Schaltgeräte GmbH.

EN

10.4 Returning the Device

Use the "Service form" to return the device when repair/service is required.
On the internet site "www.stahl-ex.com" under "Downloads > Customer service":

- Download the service form and fill it out.
- Send the device along with the service form in the original packaging to R. STAHL Schaltgeräte GmbH.

11 Cleaning

- Clean the device only with a cloth, brush, vacuum cleaner or similar items.
- When cleaning with a damp cloth, use water or mild, non-abrasive, non-scratching cleaning agents.
- Do not use aggressive detergents or solvents.

12 Disposal

- Observe national and local regulations and statutory regulation regarding disposal.
- Separate materials when sending it for recycling.
- Ensure environmentally friendly disposal of all components according to the statutory regulations.

13 Accessories and Spare Parts

NOTICE	
Use only original accessories and spare parts by R. STAHL Schaltgeräte GmbH.	

	<p>For accessories and spare parts, see data sheet on our homepage www.stahl-ex.com.</p>
---	--





