

isbus fieldbus technology
the comprehensive selection for your installation



Asset Management Level

Control Level

Modern and effective High Power Trunk installation



Backbone

PLC/DCS (host)



Reactive physical layer diagnostics



Proactive physical layer diagnostics



Online physical layer diagnostics



Trend monitoring



Power management with softstart



Optimized for Zone 2 / Zone 1

Fieldbus FF H1

Fieldbus Power Supply



Diagnostics

Field Level Zone 2

Zone 2 Ex n FDC



12x Ex ic (nL)

(12x Ex d, nA)

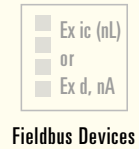

Zone 2 Ex i FDC



8x Ex ia/FISCO

Zone 1 Ex i FDC



8x Ex ia/FISCO



Zone 1 Ex e FDC



8x Ex e

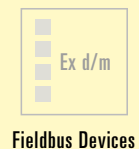

Digital I/O Coupler



4x Ex i output

8x Ex i input

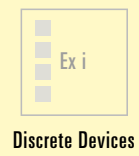

Fieldbus FF H1 high power trunk (Ex e/nL.)

Terminator



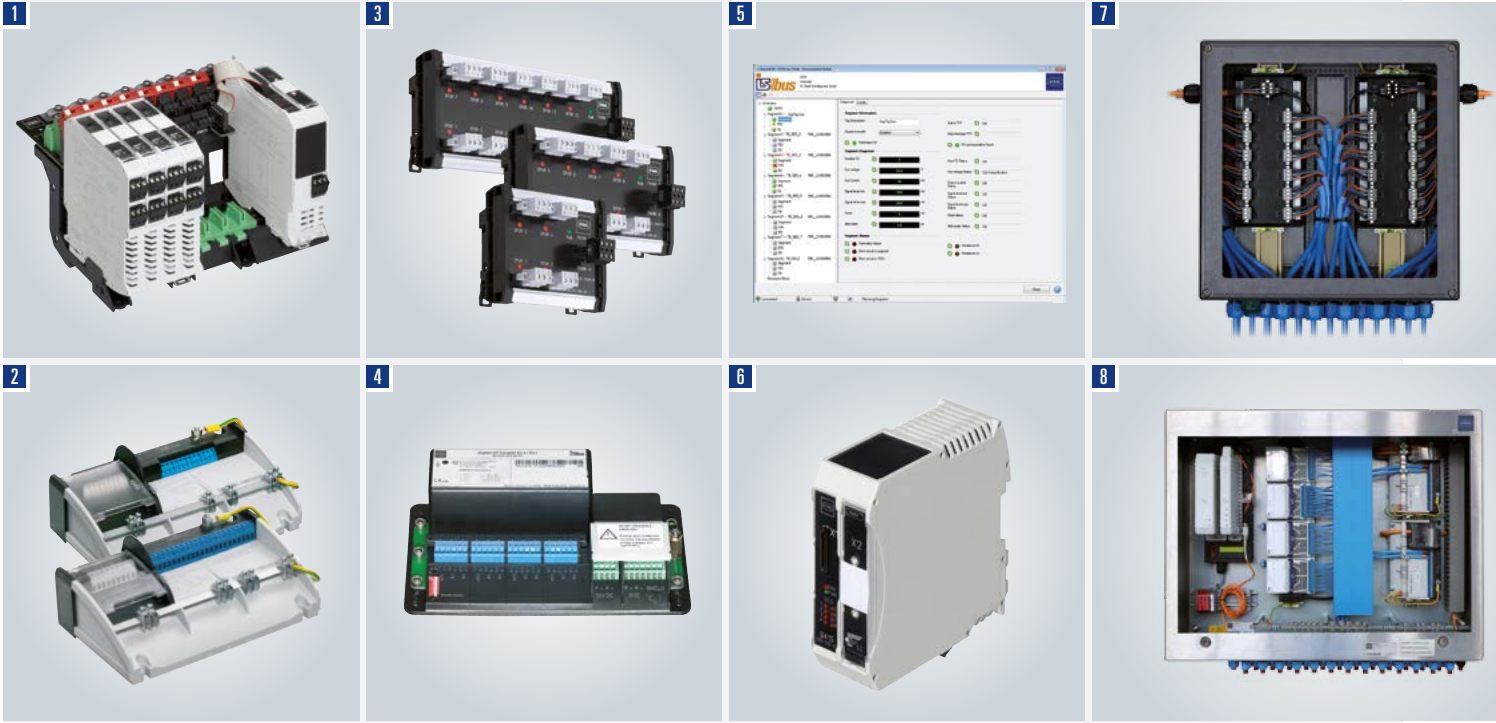

ISbus Fieldbus solutions



Three generations of field devices are in use in the process industries and hazardous areas today. There are the conventional sensors and actuators with analogue 4...20mA signals and the HART field devices. Besides the point to point solutions with isolators, this does of course relate to explosion protected remote I/O systems where conventional and HART devices can be interfaced efficiently with automation systems using digital communication technologies like PROFIBUS DP or Fast Industrial Ethernet.

With FOUNDATION™ Fieldbus H1 and Profibus PA the third generation of field devices was introduced some years ago. The predominant types of protection for explosion protected sensors and actuators continue to be intrinsically safe “Ex i” and flameproof “Ex d” in Zone 1 and Division 1. The FISCO specification was developed for an intrinsically safe fieldbus to increase the number of fieldbus devices per segment. However, the number of connectable fieldbus devices is still small when using a pure FISCO fieldbus installation.

Far more power can be provided for much more fieldbus devices with the so-called “High Power Trunk” concept that utilizes a non-intrinsically safe fieldbus trunk that is connected to FISCO fieldbus devices via isolating device couplers. Today this is the best way of implementing an efficient and economical installation to power an adequately large number of fieldbus devices.

R.STAHL has made it business to provide efficient and economical solutions with suitable device couplers, fieldbus power supplies and advanced physical layer diagnostics tools for fieldbus installations. Customized solutions with enclosures in different materials and sizes, extensive accessories plus the long-time engineering experience for hazardous area applications round up the fieldbus product range of ISbus.

- 1 ISbus Fieldbus Power Supply
- 2 ISbus Fieldbus Zone 1 Field Device Coupler
- 3 ISbus Fieldbus Zone 2 Field Device Coupler
- 4 ISbus Fieldbus Zone 1 Digital I/O Coupler

- 5 ISbus Fieldbus Diagnosis DTM
- 6 Diagnosis Communication Module DCM
- 7 Field Device Coupler, Zone 2 field enclosure
- 8 Customized solution integrating remote I/O and fieldbus FF H1



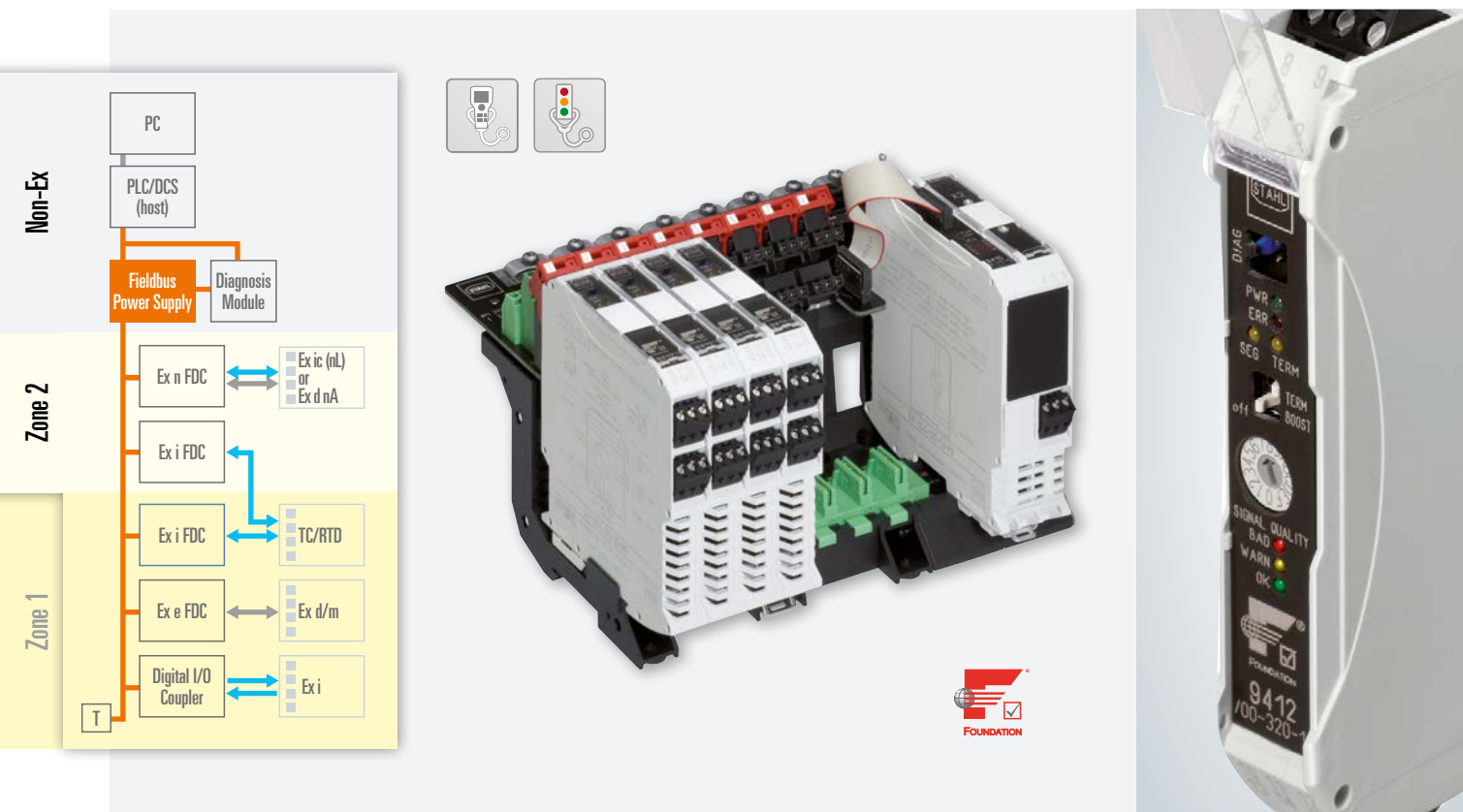

Fieldbus power supply & diagnostics

for simple and redundant segment supply

The ISbus Fieldbus Power Supplies series 9412 serve for energy supply and signal conditioning of simple and redundant FOUNDATION™ Fieldbus H1 segments.

All 9412 Fieldbus Power Supplies feature integrated advanced physical layer diagnostics to measure the electrical bus quality with signal level, noise, jitter and unbalance down to the single fieldbus device. A front-side service interface allows direct connection of a PC to display these values on the screen.

The Advanced Fieldbus Power Supply uses the physical layer diagnostics to detect quality changes of the fieldbus and to generate adjustable pro-active warning messages via “traffic light” LEDs and relay contact.

For online access to the parameters, a Diagnosis Communication Module (DCM 9415) is available to connect host and asset management systems via the H1 network and DTM or EDD.

The devices can either be fitted onto the DIN-rail or engaged securely into the special bus-Carriers. With each bus-Carrier it is possible to connect up to 8 segments with simplex or redundant supply to a host by means of pre-assembled system cables.

Highlights



- galvanic isolation between fieldbus segment and power
- high output power of up to 28 V and 500 mA or 1 A (boost mode)
- integrated diagnostics for supply, signal, noise, jitter and unbalance
- alarm contact for failures
- optional with adjustable alarm levels and 3 LED indicators
- display of diagnostic information on PC
- integrated, switchable terminator
- various bus-Carriers for 4 or 8 segments, simplex and redundant available

WebCode 9412A

WebCode 9419B

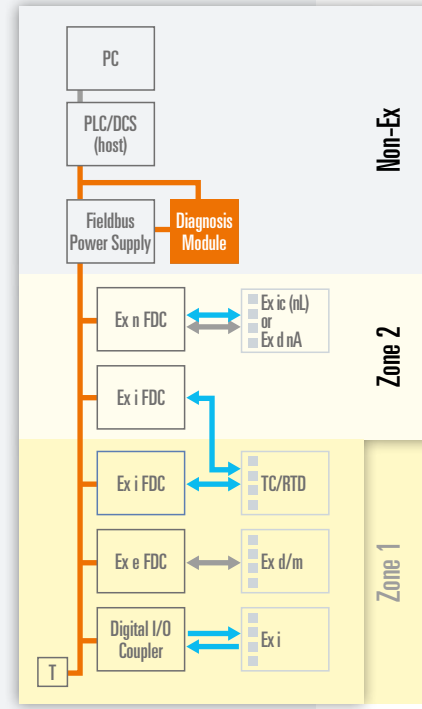
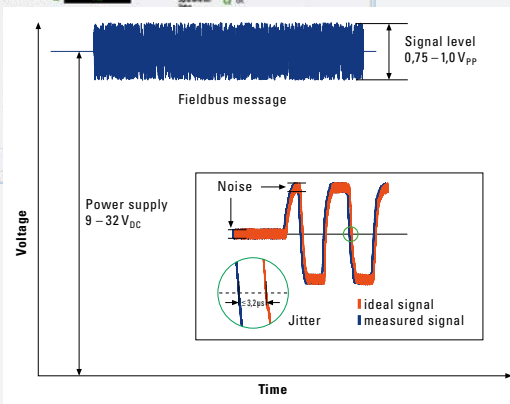
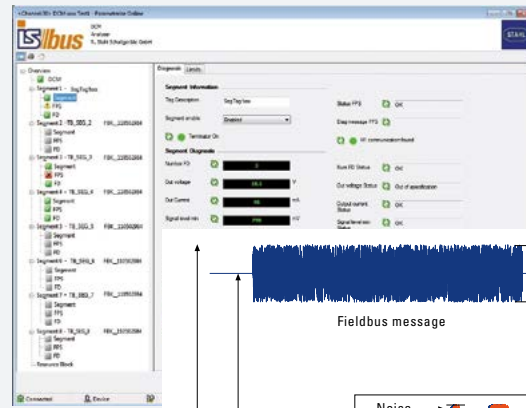

Diagnosis communication module

advanced physical layer diagnostics via H1 network



Highlights



- for FOUNDATION™ Fieldbus H1
- transmission of diagnostics data from up to 8 FF H1 segments
- physical layer diagnostics: voltage/current values, jitter, noise, signal level, unbalance
- simple integration into asset management systems via FF H1 and EDD or DTM
- diagnostics handling according to NAMUR NE 107 and FF-912
- LEDs for diagnostics and operation

The Diagnosis Communication Module (DCM) transmits advanced physical layer diagnostics data, measured by the ISbus Fieldbus Power Supplies, to a host and/or asset management system via FF H1 communication.

All the ISbus Fieldbus Power Supplies are continuously measuring the relevant physical layer values according to NAMUR NE 123, like supply, noise, signal level, jitter and unbalance. The DCM reads the values from the Fieldbus Power Supplies for up to 8 segments and transmits all the diagnostics information according to FF-912 and NAMUR NE107 over a freely definable FF H1 segment.

The online integration into host and asset management tools is done either via an EDD or a DTM, offering sophisticated possibilities for setting alarm and pre-alarm levels, obtaining life maintenance data from the bus and creating detailed reports.

The DCM is installed on the same bus-Carrier as the Fieldbus Power Supplies on a dedicated slot in safe areas or Zone 2.

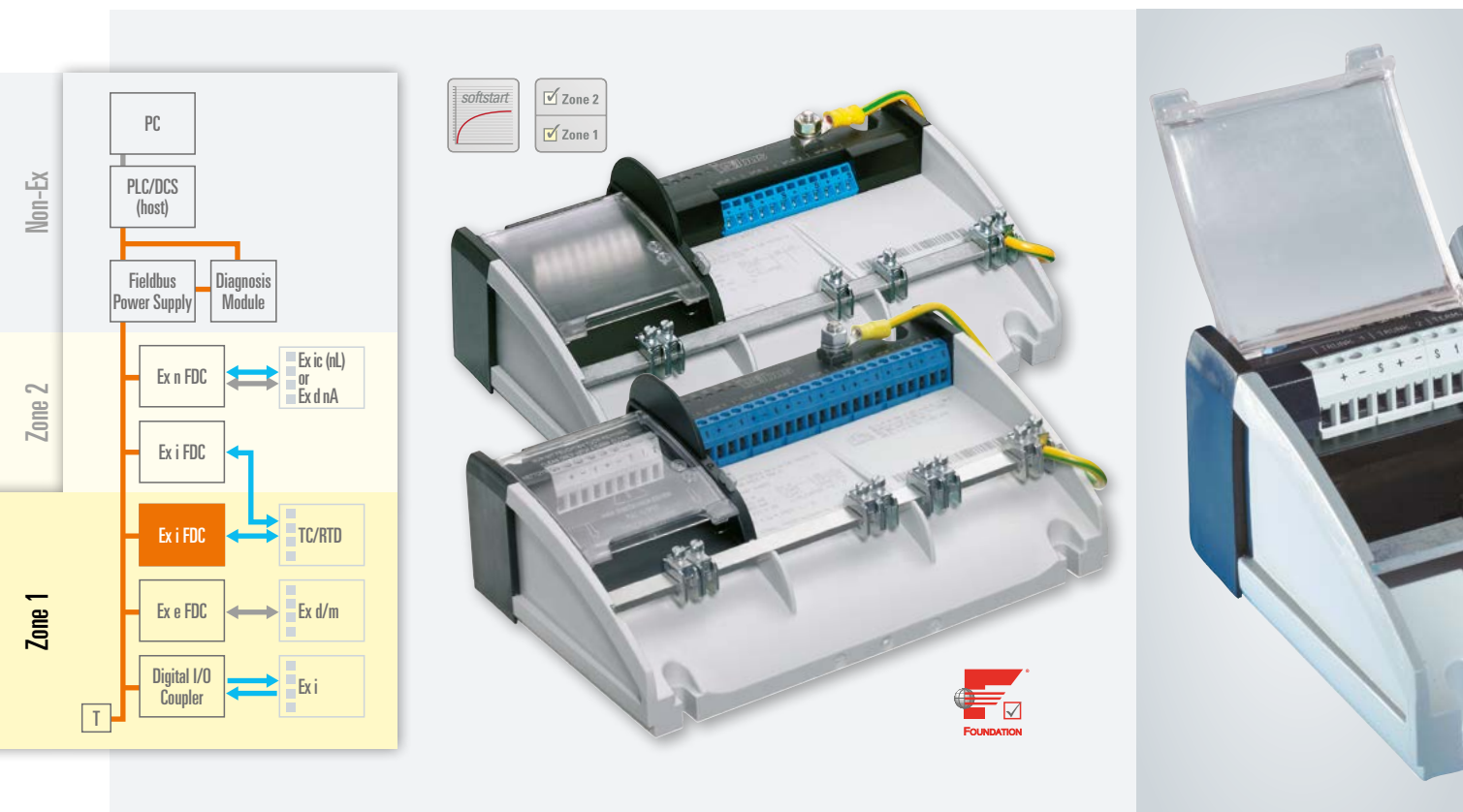

Field device coupler

for Zone 1 installations and Ex i devices

The Zone 1 Ex i Field Device Coupler (FDC) connects 4 or 8 FISCO or entity fieldbus devices to the non-intrinsically safe High Power Trunk.

Fieldbus devices are powered with up to 41 mA each. The intrinsically safe spurs are galvanically isolated from the trunk and a feedback effect is prevented in the case of short circuits by 50 mA current limiting per spur. LEDs clearly indicate status and failure of the spurs and a switchable terminator is integrated.

All the R. STAHL Field Device Couplers feature a power management (see page 7) that simplifies engineering and commissioning and maximizes cable lengths and number of field devices per segment.

The coupler is mounted on a DIN rail in GRP, aluminium or stainless steel enclosures. The cables are connected with screw terminals, detachable screw terminals or with spring clamp terminals. The cable shields can be earthed capacitively or directly at the integrated shielding bar. Hot work in hazardous areas can be carried out on the intrinsically safe spurs due to an IP 30 cover that protects the non-intrinsically safe connections of the trunk.

The Zone 1 Ex i Field Device Coupler can be installed in Zone 1 or Division 2 and connected to fieldbus devices in Zone 1 or Division 1.

Highlights



- for FOUNDATION™ Fieldbus H1 or Profibus PA
- 4 and 8 spur versions available
- galvanic isolation between fieldbus devices and trunk
- spur protection for each spur
- power management with softstart and short circuit limitation
- LED indication of status and faults on each spur
- switchable termination on board
- screw, detachable screw or spring clamp terminals

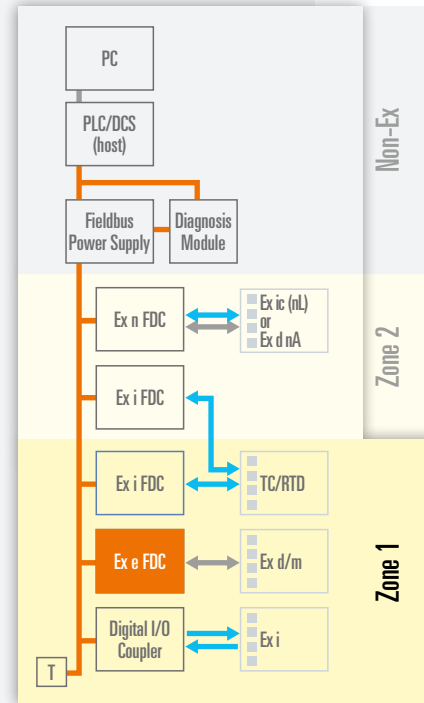
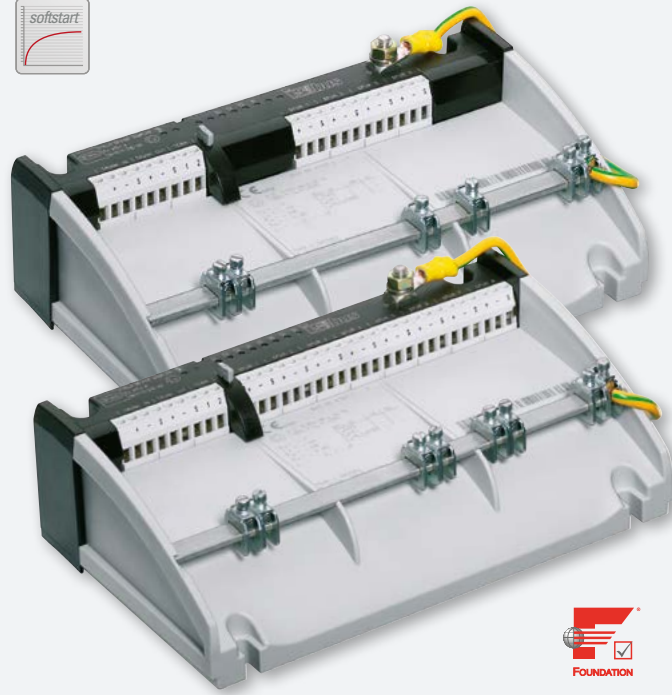

Field device coupler

for Zone 1 installations and Ex d/m/q devices



Highlights



- for FOUNDATION™ Fieldbus H1 or Profibus PA
- 4 and 8 spur versions available
- spur protection for each spur
- power management with softstart and short circuit limitation
- LED indication of faults on each spur
- switchable termination on board
- screw or spring clamp terminals

The Zone 1 Ex e Field Device Coupler connects 4 or 8 non-intrinsically safe fieldbus devices to the High Power Trunk.

The fieldbus devices in type of protection Ex d, Ex q or Ex m can each be powered with up to 41 mA. Each spur features 50 mA current limiting in order to prevent feedback effects on the trunk in the event of short circuits. A red LED per spur clearly indicates such a failure condition. Installation, wiring, enclosures, terminals and shielding etc. are designed as for the Ex i Field Device Couplers.

Power Management

All R.STAHL Field Device Couplers feature two functionalities to lower the current consumption on the trunk under all conditions as much as possible:

- The softstart function – as soon as the trunk voltage at the couplers exceeds 16 V, the spurs are activated one after the other which results in a significantly lower inrush current during start-up for longer cable runs and more fieldbus devices per segment.
- Short circuit limitation – in the event of multiple spur short circuits, all spurs are de-energized until the failure is eliminated. Even with multiple short circuits, the trunk is loaded with a maximum of only one short circuit current at a time.

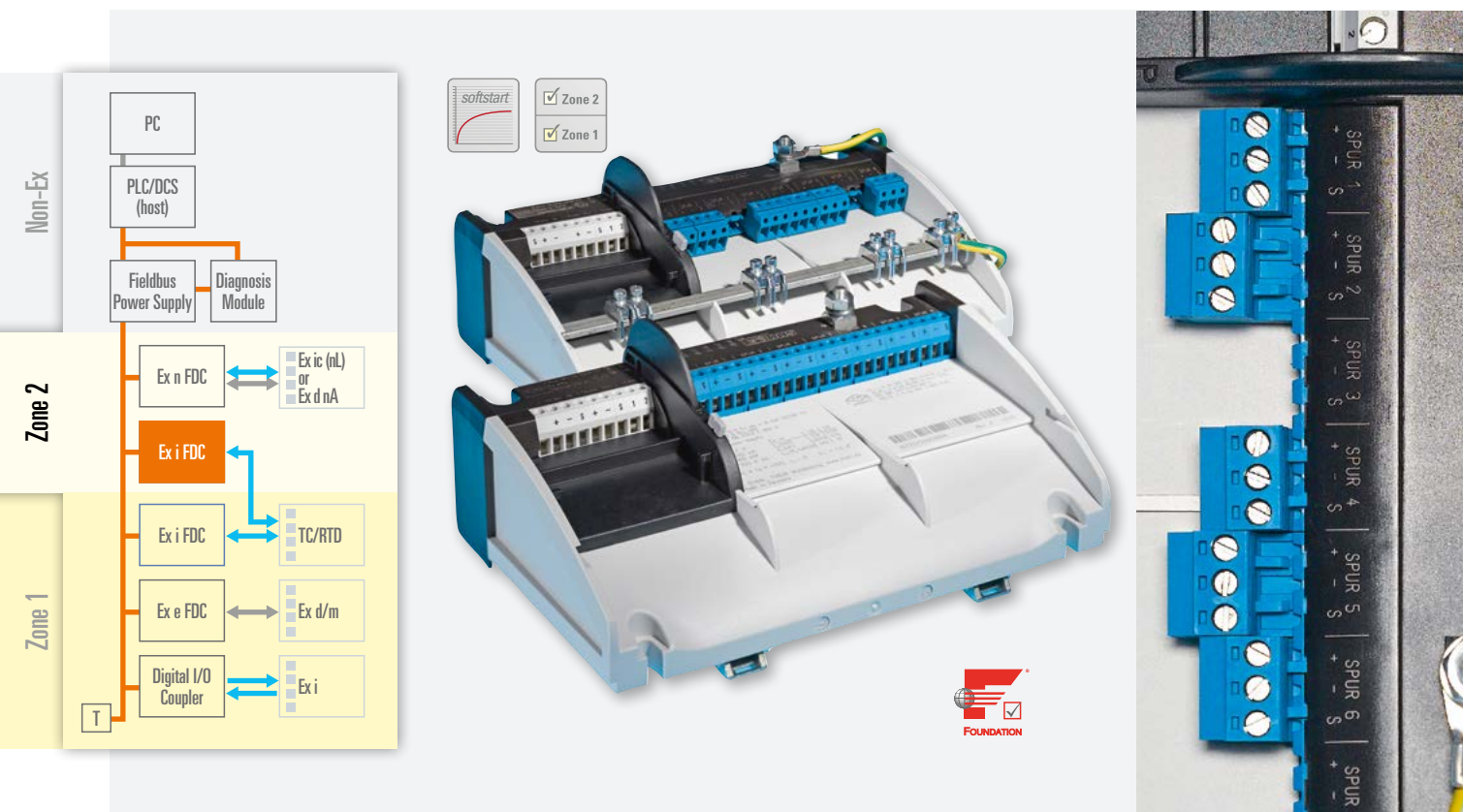

Field device coupler

for Zone 2 installations and Ex i devices

The Zone 2 Ex i Field Device Coupler (FDC) connects 4 or 8 FISCO or entity fieldbus devices to the non-intrinsically safe High Power Trunk.

Fieldbus devices are powered with up to 41 mA each. The intrinsically safe spurs are galvanically isolated from the trunk and a feedback effect is prevented in the case of short circuits by 50 mA current limiting per spur. LEDs clearly indicate status and failure of the spurs and a switchable terminator is integrated.

All the R. STAHL Field Device Couplers feature a power management (see page 7) that simplifies engineering and commissioning and maximizes cable lengths and number of field devices per segment.

The coupler is mounted on a DIN rail in GRP, aluminium or stainless steel enclosures. The cables are connected with screw terminals, detachable screw terminals or with spring clamp terminals. The cable shields can be earthed capacitively or directly at the optional shielding bar.

The Zone 2 Ex i Field Device Coupler can be installed in Zone 2 or Division 2 and connected to fieldbus devices in Zone 1 or Division 1.

Highlights



- for FOUNDATION™ Fieldbus H1 or Profibus PA
- very cost effective isolating device coupler for Zone 2
- 4 and 8 spur versions available
- galvanic isolation between fieldbus devices and trunk
- spur protection for each spur
- power management with softstart and short circuit limitation
- LED indication of status and faults on each spur
- switchable termination on board
- screw, detachable screw or spring clamp terminals

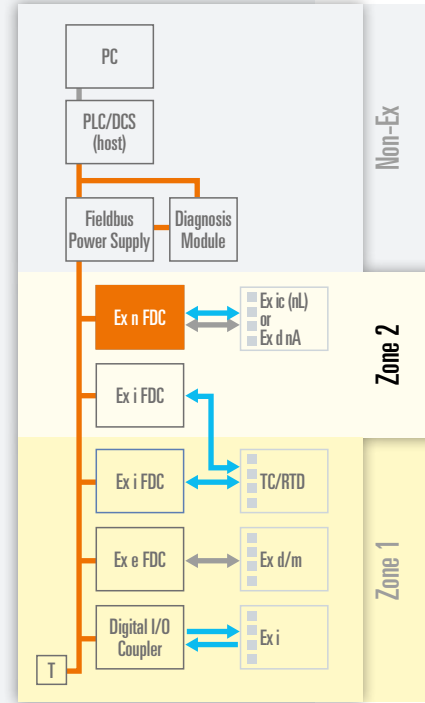

Field device coupler

for Zone 2 installations and Ex ic (nL) devices



Highlights



- for FOUNDATION™ Fieldbus H1 or Profibus PA
- 4, 8 and 12 spur versions available
- spur protection for each spur
- power management with softstart and short circuit limitation
- LED indication of faults on each spur
- detachable screw terminals

The Zone 2 Ex n Field Device Coupler connects 4, 8 or 12 Zone 2 fieldbus devices in type of protection Ex ic (former nL) or nA or Zone 1 Ex d/q/m fieldbus devices to the High Power Trunk.

Fieldbus devices are powered with up to 41 mA. Each spur features 50 mA current limiting in order to prevent feedback effects on the trunk in the event of short circuits. A red LED per spur clearly indicates such a failure condition.

Like all the other couplers, this field device coupler also features the power management described on page 7.

The coupler is mounted on a DIN rail in GRP, aluminium or stainless steel enclosures. The cables and the cable shields are connected to the detachable screw terminals that are locked with screws against loosening. The trunk cable can be looped through to other couplers on the segment by a t-connector. For termination at the end of the trunk, an external terminator is available that is connected to the t-connector as well.

The Ex n field device coupler can be installed in Zone 2 or Division 2.



Digital I/O coupler for Zone 1 and Ex i discrete I/O devices

The Ex i Digital I/O Coupler connects up to 4 intrinsically safe discrete output devices and up to 8 intrinsically safe discrete input devices to the High Power Trunk. Alternatively, the Ex i Digital I/O Coupler can be used on a FISCO trunk or spur.

The coupler features 8 fully fledged, non-multiplexed Ex i NAMUR inputs for contacts or proximity switches and 4 Ex i discrete outputs. These 4 outputs are able to drive standard I.S. solenoid valves with up to 13 V @ 30 mA each. All inputs and outputs feature open-circuit and short-circuit monitoring and are galvanically isolated from the trunk.

The coupler is powered from an external 24 V power supply what reduces the load on the fieldbus trunk significantly. It supports various FOUNDATION™ Fieldbus function blocks such as DI, DO, DO-valve, MDI, MDO and also AI for frequencies of up to 20 kHz, CI for counters and a logic transducer block (LTB).

The Ex i Digital I/O Coupler can be installed in Zone 1 or Division 2, with the discrete devices installed in Zone 1 or Division 1.

Highlights 

- for FOUNDATION™ Fieldbus H1
- 8 Ex i discrete inputs, (acc. to EN 60947-5-6 / NAMUR)
- 4 Ex i discrete outputs with 13 V @ 30 mA
- operation on High Power Trunk or FISCO fieldbus/spur
- LED indication for power and fieldbus operation
- LED indication for input/output status and line fault (option)
- support of numerous function blocks (DI, DO, DO-valve, MDI, MDO, AI, CI, LTB)

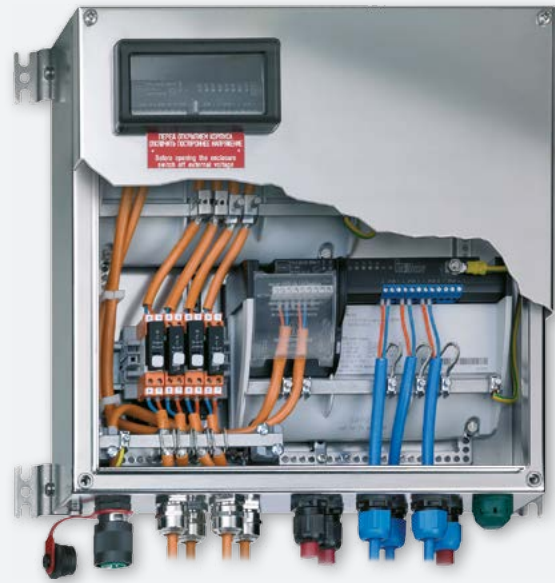

Fieldbus accessories

for hazardous areas and harsh environments



Highlights



- enclosures in many sizes in polyester resin (GRP), aluminium, sheet steel and stainless steel
- certified inspection windows, various sizes
- cable glands made of plastics, brass nickel plated or stainless steel
- fieldbus terminators Ex i or Ex m
- Ex-plug connectors miniCLIX with y-adapter for hot-swap function
- fieldbus cables for outside and inside installation

Fieldbus installations require not only devices and software functions, but also suitable installation accessories; of course explosion protected and certified for hazardous areas. Products for Zone 1 or Zone 2 (IEC) and Division 1 or 2 (NEC) are required according to the location and region in which they are used.

R. STAHL supplies a comprehensive range of accessories with all international certificates to the requirements of ATEX (Europe), FM (USA and Canada) or IECEx and many more. Field enclosures and distribution boards in different sizes, made of polyester resin (GRP), aluminium or stainless steel with the corresponding cable glands in plastics or metal are available.

Fieldbus terminators for direct cable entry installations as well as special Ex-plug connectors or separation switches with which the High Power Trunk can be used for hot swap are also possible. Devices for surge protection of trunk and/or spurs can be equipped as well. Last but not least, a large choice of pre-assembled fieldbus cables is available also in special colour blue for intrinsically safe installations.



Fieldbus engineering

customized solutions to meet your requirements

Today, differing applications and diverse customer requirements lead to simultaneous use of several fieldbuses. In addition, mechanical concepts matched to the required tasks and ambient conditions are required.

R.STAHL, together with its customers, plans the selection of the components, bus systems and field-compliant enclosures, matched to the required tasks and ambient conditions. We are able to supply the optimum all-in solution for the interface between field devices and automation system: for conventional sensors and actuators, for HART field devices, for fieldbus devices, and for any combination of them.

Integration of third party components like e.g. solenoid valve islands and special designs for extreme ambient temperatures is our daily work. And of course, all customized R.STAHL system solutions come certified for installation in the respective hazardous area – ready to run!

1 Fieldbus junction boxes for mega project in India

2 Zone 1 Fieldstation with fieldbus and remote I/O

3 Very compact 16 spur design for Zone 1 Ex i FDC with maintenance switch and inspection windows

4 Customized solution integrating remote I/O, fieldbus FF H1 and valve islands

Highlights

- more than 30 years of experience with system solutions for hazardous areas
- one of the largest product offerings for installations in Zone 1, Zone 2, Div. 1 and Div. 2
- highly qualified personnel for fieldbus and remote I/O engineering
- inspection of installations with FF H1, PROFIBUS and Ethernet
- testing and documentation for GAMP and FDA
- customer seminars and training for explosion protection
- after sales support, hotline and on-site support
- international certification network for all explosion protection topics



Fieldbus meets remote I/O

IS1+ ethernet remote I/O goes F-ROM and PROFINET



Highlights



- remote I/O for Fast Industrial Ethernet: Modbus TCP, EtherNet/IP; PROFINET and F-ROM
- installation in Zone 1, Zone 2 or Division 1, Division 2
- 100 Mbit/s Fast Industrial Ethernet via optically inherently safe fibre-optics
- redundant Ethernet interworking; very short switchover time down to 200 ms
- hot-swap of all modules: CPU, Power, I/O modules
- all standard IS1+ I/O modules can be used
- high-performance Ethernet Device DTM for configuration and diagnosis

Ready? Then let's go: Industrial Ethernet technology makes its appearance in the sector of process automation and fieldbus technology. This renders integration of remote I/O in plant structures even simpler. Universal field stations for connection of a wide variety of sensors and actuators will communicate via Fast Industrial Ethernet with the automation systems.

R. STAHL is making the crucial step into the future right now with the explosion protected Remote I/O System IS1+ on High Speed Ethernet. Available for installation in Zone 1 and 2 or Division 1 and 2.

The explosion protected Ethernet interface is based on fiber optic cables and uses the type of protection „optically inherently safe (op is)“ according to IEC 60079-28. Fibre optic cables allow very long distance communication and no interference due to

poor shielding or electromagnetic influences can influence the communication.

Fieldbus organizations like PROFIBUS International and the Fieldbus FOUNDATION™ have already introduced new and very powerful Ethernet based solutions with PROFINET or F-ROM (Foundation for Remote Operations Management).

R. STAHL actively participates in these working groups, aiming at integration of remote I/O technology in the communication architectures of the future. Regardless of the technology our customers ultimately choose, R. STAHL provides efficient and economical solutions.

IS1+ Ethernet: ready for PROFINET, ready for F-ROM, ready for the future!



Fieldbus references



How to connect vibration sensors to the fieldbus

This chemical production unit in Germany required a smart and very fast device to convert oscillating signals into the Foundation H1 network. The Digital I/O Coupler series 9413 was the perfect solution for this. The good design of the enclosures was another convincing argument for ISbus.



Fieldbus to the max

Maybe the largest PROFIBUS PA installation in North America by a German chemical company. The segments were loaded with up to 20 fieldbus devices, resulting in large inrush currents. Only with the ISbus Power Management and softstart function was it possible to commission the installation without additional measures and work load.



International fieldbus excellence

In this large project, the experience of the R. STAHL international projects team was required: Project engineering by four companies in South Korea, package units from Germany and Japan and installation for a refinery expansion in Abu Dhabi to more than double the production.

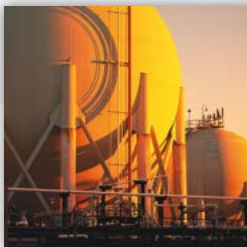

One of the world's largest FF installations

For a refinery on the east coast of India, R. STAHL has supplied the whole fieldbus installation material for Zone 2 and Zone 1. Several thousands of fieldbus devices are connected to the High Power Trunk via isolating device couplers in customized designed field enclosures with integrated trunk separation switches.



Device Couplers in stainless steel enclosures

One of R. STAHL's many fieldbus installations in Brazil can be found in a large treatment and compress plant for natural gas. Several hundreds of FDC are installed in stainless steel boxes with even stainless steel cable glands.



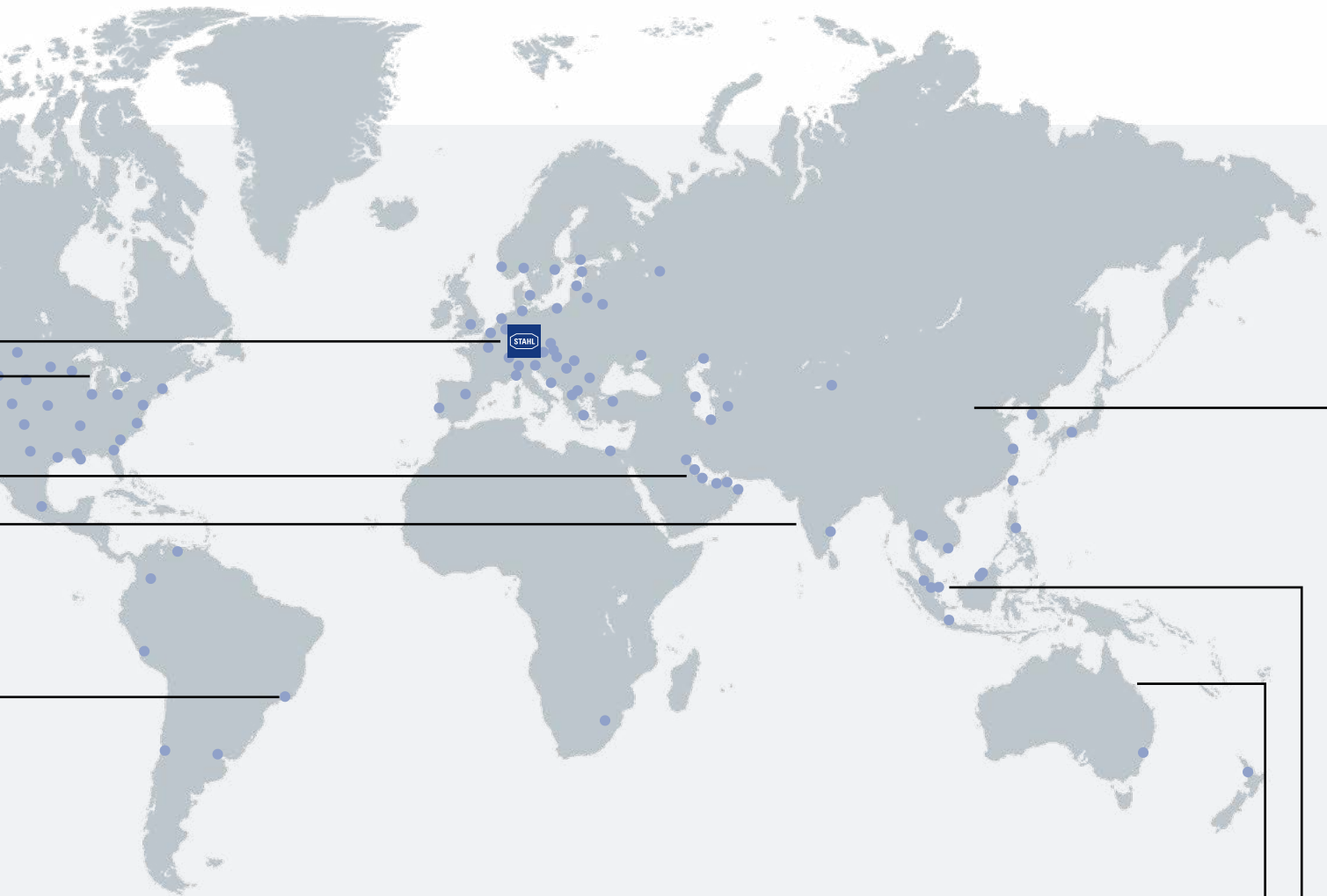

High reliability for low maintenance and low life cycle costs

A fieldbus installation for coal seam gas exploration and water treatment in Queensland/Australia. The very cost effective ISbus Zone 2 device couplers with 12 spurs have been selected by the customer due to the robust design and solid field enclosures.

© copyright by APLNG



Fieldbus and surge protection plus service

One of the world's top 10 producers of group III base oil in Malaysia selected a complete package of isolating device couplers with surge protection devices installed in stainless steel enclosures. After installation, a site inspection was done by the R. STAHL service to review installation and grounding network for proper function.

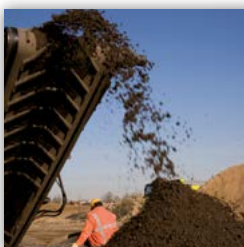

Powerful diagnostics for high quality products

This Chinese producer of high quality activated carbon was looking for physical layer diagnostics for his fieldbus installation. With the R.STAHL fieldbus power supply and the H1 diagnosis communication module, an easy-to-use but very powerful tool was selected. A very quick delivery for the time-critical installation completed the package.



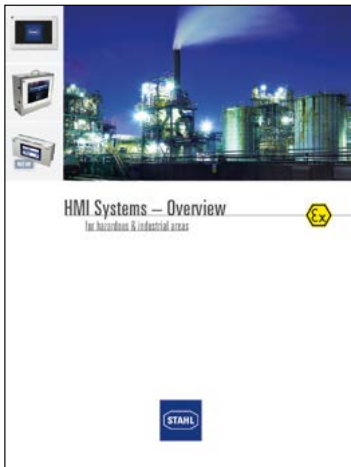

ISbus videos



R. STAHL

Am Bahnhof 30,
74638 Waldenburg, Germany
T +49 7942 943-0
F +49 7942 943-4333

 www.stahl.de



ID 102617

2014-09 / EN-04 - Printed in Germany