



THE STRONGEST LINK.

Operating Instructions

Device platform EAGLE

ET-xx6-A-*

SERIES 300 Operator Interfaces
SERIES 400 Panel PC
SERIES 500 Thin Clients

(valid for HW Revision 3., 2. supplement)

R. STAHL HMI Systems GmbH
Adolf-Grimme-Allee 8
D 50829 Köln

HW-Rev. ET-xx6-A-FX:	03.02.12
HW-Rev. ET-xx6-A-TX:	03.02.22
HW-Rev. ET-xx6-A-FX-BT:	03.02.16
HW-Rev. ET-xx6-A-TX-BT:	03.02.26
HW-Rev. ET-3x6-A-FX-BS:	03.02.17
HW-Rev. ET-3x6-A-TX-BS:	03.02.27

Operating Instructions Version:	03.02.16
Issue date:	27.11.2019

Disclaimer

Publisher and copyright holder:

R. STAHL HMI Systems GmbH
Adolf-Grimme-Allee 8
D 50829 Köln

Phone:	(switchboard)	+49 (0) 221 76 806	- 1000
	(hotline)		- 5000
Fax:			- 4100
E-mail:	(switchboard)	office@stahl-hmi.de	
	(hotline)	support@stahl-hmi.de	

- All rights reserved.
- This document may not be reproduced in whole or in part except with the written consent of the publisher.
- This document may be subject to change without notice.

Any warranty claims are limited to the right to demand amendments. Liability for any damage that might result from the content of this description or all other documentation is limited to clear cases of premeditation.

We reserve the right to change our products and their specifications at any time, provided it is in the interest of technical progress. The information in the current manual (in the internet and on CD / DVD / USB stick) or in the operating instructions included with the HMI device applies.

Trademarks

The terms and names used in this document are registered trademarks and / or products of the companies in question.

Copyright © 2019 R. STAHL HMI Systems GmbH. Subject to alterations.

Specific markings

The markings in these operating instructions refer to specific features that must be noted.

In detail, these are:

 DANGER	This sign alerts users to hazards that will result in death or serious injury if ignored !
---	---

 WARNING	This sign alerts users to hazards that may result in death or serious injury if ignored !
--	--

 CAUTION	This sign alerts users to hazards that may damage machinery or equipment or result in injury if ignored !
--	---

 ATTENTION	Information highlighted by this symbol indicates measures for the prevention of damage to machinery or equipment !
--	--

 NOTICE	Information highlighted by this symbol indicates important information of which particular note should be taken !
---	---

 DOCUMENTATION	Information highlighted by this symbol refers to a different chapter or section in this manual or other documentation or a web-page !
--	---

Warnings

	Caution ! In ambient temperatures exceeding +45 °C the surface of the devices may heat up. Caution when touching!
---	---

	Caution ! The laser diodes installed in our Exicom operator devices, media converters and switches emit invisible laser radiation: 100Base-FX - 1300 nm FO-MM / 1000Base-SX - 770 ... 860 nm FO-SM / 1000Base-LX - 1270 ... 1355 nm Acc. to EN 60825-1 the laser diode is classified as a class 1M laser / Do not view directly with optical instruments. The viewing of the laser beam through certain optical instruments (e.g. magnifying glasses, telescopes and microscopes) from a distance of less than 100 mm may damage eyesight. (beam output at the emitting diode (TD-A, TD-B) or the fibre optic end).
---	---

Table of contents

	Description	Page
	Disclaimer	2
	Specific markings	3
	Warnings	3
	Table of contents	4
1	Preface	7
2	Device function	7
2.1	Image sticking	7
2.2	Processor types	7
2.3	Activation pressure touchscreen	7
2.4	ET-3x6-A-* (SERIES 300 Operator Interfaces)	8
2.5	ET-4x6-A-* (SERIES 400 Panel PC)	8
2.6	ET-5x6-A-* (SERIES 500 Thin Clients)	8
2.7	Overview hardware revision ET-xx6	8
3	Technical Data	9
3.1	Additionally for ET-3x6-A-* (Operator Interfaces)	12
3.1.1	All devices up to hardware revision 03.02.x2	12
3.1.2	All devices starting from hardware revision 03.02.x5	12
3.1.3	All devices starting from hardware revision 03.02.x7	12
3.2	Additionally for ET-4x6-A-* (Panel PC)	12
3.2.1	All devices up to hardware revision 03.02.x2	12
3.2.2	All devices starting from hardware revision 03.02.x4	12
3.2.3	All devices starting from hardware revision 03.02.x6	12
3.3	Additionally for ET-5x6-A-* (Thin Clients)	13
3.3.1	All devices up to hardware revision 03.02.x2	13
3.3.2	All devices starting from hardware revision 03.02.x4	13
3.3.3	All devices starting from hardware revision 03.02.x6	13
4	Conformity to standards	13
5	Certificates	14
5.1	ATEX	14
5.2	IECEX	14
5.3	EAC (TR)	15
5.4	PESO	15
5.5	CNEX	15
5.6	DNV / GL	15
5.7	ABS	15
5.8	LR	15
6	Marking	16
7	Power supply	17
7.1	HMI devices	17
7.1.1	HMI device terminals	17
7.1.1.1	Tightening torque	17
8	Permitted maximum values	18
8.1	External, non-intrinsically safe circuits	18
8.2	External inherently safe optical interface	19

8.3	External intrinsically safe circuits	19
9	Type code	22
9.1	Certificate	22
9.2	Order variant	23
9.2.1	ET-3x6-A (Operator Interfaces)	23
9.2.2	ET-3x6-A-*-BS (Operator Interfaces)	24
9.2.3	ET-4x6-A (Panel PC)	25
9.2.4	ET-4x6-A-*-BT (Panel PC)	26
9.2.5	ET-5x6-A (Thin Client)	27
9.2.6	ET-5x6-A-*-BT (Thin Client)	28
10	Safety Advice	29
10.1	Installation and operation	29
10.2	Cautionary notes	30
10.3	Special conditions	30
11	Installation	31
11.1	General information	31
11.2	ET-xx6-A-*	31
11.2.1	HMI device Installation in housings type of protection "e" or "t"	31
11.2.2	Cable glands	32
11.3	Usage of the USB-interfaces	33
11.3.1	Usage of USB Memory-Sticks	33
11.3.2	Usage of external USB devices	33
11.4	USB interfaces	34
11.4.1	I.S. USB interfaces USB0, USB2	34
11.4.2	Ex e USB interfaces USB1, USB3	34
11.4.2.1	Connection variations for Ex e USB interfaces	34
11.4.2.2	Connection terminal with protection type "e" (IEC/EN 60079-7)	35
12	Assembly and disassembly	36
12.1	General information	36
12.2	Cut-out ET-xx6-A-*	36
13	Operation	37
13.1	General information	37
13.2	Connections	37
13.2.1	Dip switch settings S3 and S4	39
13.2.1.1	Serial interface COM1	39
13.2.1.2	Serial interface COM2	39
13.2.2	View connection compartment	40
13.2.3	Status LEDs	40
13.2.3.1	LEDs	40
13.3	Connection of Readers	42
13.3.1	Type RSi1 connection version 1	42
13.3.1.1	Type RSi1 connection version 2	42
14	Maintenance, service	43
14.1	Damaged sealing	43
14.2	Servicing	43
14.3	Saving data with ET-3x6-A-*	43
14.4	Time function	44

15	Troubleshooting	44
16	Disposal	44
16.1	RoHS directive 2011/65/EC	44
16.1.1	China RoHS labelling	44
17	General Information	45
17.1	Touch driver	45
17.2	Keyboard features	45
17.3	ET-4x6-A-* (Panel PC)	46
17.3.1	Up to Windows 7 operating systems	46
17.3.1.1	Licensing issues	46
17.3.1.2	Note on Windows Embedded operating systems	46
17.3.2	Windows® 10 IoT Enterprise 2016 LTSB operating system	46
17.3.2.1	Recovery	47
17.3.2.2	Company-specific Windows installations	47
17.3.3	Initial start-up	47
17.3.4	Recovery Stick	47
17.3.5	Back-up	47
17.3.6	Switching off / closing down	48
17.3.7	Data loss	48
17.4	Defective pixels	49
17.4.1	Terminology	49
17.4.2	Display specification	50
18	Declaration of EC conformity	51
18.1	RCM	52
19	Release notes	54

1 Preface

These Operating Instructions contain all aspects relevant to explosion protection for the ET-xx6-A-* HMI devices (SERIES 300 Operator Interfaces - Eagle, SERIES 400 Open HMI - Panel PC's and SERIES 500 Thin Clients). They also contain information on the connection and installation of these devices.

These operating instructions contain a joint description of all three product lines: Operator Interfaces, Panel PC's and Thin Clients. Any differences between the three product lines will be explicitly mentioned and dealt with. As a rule, though, the information contained in these operating instructions applies to all models of the ET-xx6-A-* series.

The ET-xx6-A-* HMI devices with display sizes of 26 cm/10.4", 38 cm/15" and 48 cm/19" will be available in Hardware Revision 3.

 NOTICE	<p>All data relevant to explosion protection from the EC-type examination certificate were copied into these operating instructions.</p> <p>For the correct operation of all associated components please note, in addition to these operating instructions, all other operating instructions enclosed in this delivery as well as the operating instructions of the additional equipment to be connected !</p>
---	---

 DOCUMENTATION	<p>Please note that all certificates of the HMI devices can be found in a separate document (CE_ET-xx6-A). You can find this document in the internet at r-stahl.com or request it from R. STAHL HMI Systems GmbH.</p> <p>For more information on the HMIs please also refer to the Manual (available as online manual on r-stahl.com).</p>
---	---

2 Device function

The ET-xx6-A-* HMI devices are explosion-proof equipment for installation in hazardous areas and can be installed in zones 1, 2, 21 and 22 according to ATEX directive.

All devices have a modular structure, which makes changes and maintenance easy. They can be integrated into control cabinets or panels, etc.

2.1 Image sticking

Continuous displaying fixed pattern may include image sticking. It's recommended to use screen saver or moving content periodically if fixed pattern is displayed on the screen.

2.2 Processor types

All devices are fitted with modern, powerful processors. Depending on the type of application, different processor types are used for the HMI devices (see Technical Data).

Starting in 2016, a new Intel® Atom™ processor type of the Bay Trail (BT / BS) platform will gradually replace all previous processor types in the HMI devices. This new processor type processes data four times as fast as the previous processors.

2.3 Activation pressure touchscreen

To prevent damage to the touchscreen, activation pressure on the screen must be very low (0.1 to max. 1 N).

2.4 ET-3x6-A-* (SERIES 300 Operator Interfaces)

The ET-3x6-A-* operator interfaces have been designed for the visualisation of medium-sized automation tasks, operation as built-in device and tankfarm application in hazardous areas. The Eagle operating stations have been designed to run with a proprietary operating system, making them highly secure against external manipulation.

Users operate the device via the membrane keyboard integrated into the front plate and via the LCD display with touch screen.

Communication with control and automation systems runs via the serial interfaces (RS-232 RS-422/485, Ethernet) connected in the "e"-area at the back of the devices. Various peripheral devices, such as barcode scanners, card readers, USB sticks and WLAN / Bluetooth modules can be connected via USB interfaces or optional fitted modules.

With a wealth of functions, these operator interfaces provide optimum visualization. Their active communication concept in combination with integrated functionality reduce the automation system workload.

2.5 ET-4x6-A-* (SERIES 400 Panel PC)

The ET-4x6-A-* devices are robust Panel PC's for hazardous areas. With their pre-installed Windows operating systems they are ready to run straight away.

As a standard, all Panel PC's are equipped with a touch screen and several interfaces and are based on the powerful Atom technology, making them the most powerful devices on the market.

2.6 ET-5x6-A-* (SERIES 500 Thin Clients)

The ET-5x6-A-* devices of the 500 SERIES can be integrated into modern networks as Thin Clients or with a KVM box via KVM-over-IP, thus providing ideal and flexible access options with central data administration.

The ET-5x6-A-* device, which is used for operation and visualization, is located in the hazardous area, whereas the PC that is operated is located in the safe area. Each ERP / MES network can be accessed from each Thin Client via the IP address.

The Thin Client system supports both modern technologies such as DVI and USB and older technologies such as VGA and PS/2.

2.7 Overview hardware revision ET-xx6

HW-Rev.	Device type	Technical changing	Changing date hardware	OI version	OI date
03.00.1x	ET-xx6-A-FX	Approval Rev. 3, FX interface	25.05.2011	03.00.02	09.06.2011
03.00.2x	ET-xx6-A-TX	Approval Rev. 3, TX interface			
03.00.x2	ET-xx6-A-*	5-wire touch	23.06.2014	03.00.15	03.09.2014
03.00.x3	ET-xx6-A-*	Internal changes	29.09.2014	-	-
03.00.x4	ET-xx6-A-*	Bay Trail processor, quad core	10.02.2016	03.00.17	04.01.2016
03.00.x5	ET-3x6-A-* -BS-*	Bay Trail processor, single core	08.05.2017	03.00.25	03.06.2017
03.00.x6	ET-xx6-A-*	M.2 memory	14.06.2018	03.00.29	14.07.2018
03.00.x7	ET-3x6-A-* -BS-*				
03.02.xx	ET-xx6-A-* -RS2	Approval 2nd supplement with COM2 (X22)	21.11.2012	03.02.00	16.04.2013

3 Technical Data

Function / Equipment	ET-306-A- ET-406-A-*	ET-316-A- ET-416-A- ET-516-A-*	ET-336-A- ET-436-A-*(SR) ET-536-A-*(SR)	ET-456-A- ET-556-A-*
Display type	TFT Color, 16,777,216 Colors			
Display size	26 cm (10.4")		38 cm (15")	48 cm (19")
Resolution in pixels	ET-306-A- VGA 640 x 480 ET-406-A- SVGA 800 x 600	SVGA 800 x 600	XGA 1024 x 768	SXGA 1280 x 1024
Display	Touchscreen on glass			
Touchscreen Type TFT Type SR (Sunlight readable)	5-wire analogue resistive -		5-wire analogue resistive	-
* Comment	Under extreme environmental conditions (high humidity, temperature), bubbles can form on the touch surface in rare cases. This does not represent any functional restriction and affects only the appearance.			
Backlight	LED background lighting			
Service life of backlight at +25 °C [+77 °F] +55 °C [+131 °F]	70,000 h 35,000 h			
Brightness Type TFT Type SR (Sunlight readable)	VGA 450 cd/m ² SVGA 400 cd/m ² -		350 cd/m ² 1000 cd/m ²	350 cd/m ² -
Contrast Type TFT Type SR (Sunlight readable)	700:1 -		600:1	1000:1 -
Touchscreen activation	Low activation pressure (0.1 up to max. 1 N)			
Touchscreen input method	Finger, gloved finger or stylus			
Touchscreen durability	Polyester foil is easily scratched, with high pressure force the spacer dots could be damaged.			
Touchscreen scratch hardness MoHS	-			
Touchscreen scratch hardness pencil hardness test ISO 15184	3H			
Touchscreen transmissivity / optics	Small milky effect due to the foil			
Touchscreen surface contaminants	Unaffected			
Touchscreen abrasive resistance	36 million times with a silicone rubber of R8 finger, hitting rate 250 g at 2 times per second			
Keyboard	Polyester membrane on aluminium plate (> 1 million actions)			
Functional keys	12	12	8	8
Soft keys	10	no	no	no
Cursor keys	yes	no	no	no
Alphanumeric keys	12	no	no	no
System keys	14	no	no	no
Additional keyboard	Optional 100 mA max. power consumption 105 Keys or 107 keys with integrated trackball/joystick (variant with trackball / joystick not for ET-3x6-A-*)			
Trackball / joystick	Optional for ET-4x6-A-* and ET-5x6-A-*			
Power supply	Directly in the integrated Ex e connection box			
Rated operational voltage DC	24 V			
Voltage range DC up from 100 GB data memory	20.4 - 28.8 V 21.6 - 28.8 V			
Current consumption DC	1.2 A			
Connections	via screw terminals, 2.5 mm ² (AWG14) green (Ex e) (connection X1)			
Max. operating voltage U _m	30 VDC			

Function / Equipment	ET-306-A* ET-406-A*	ET-316-A* ET-416-A* ET-516-A*	ET-336-A* ET-436-A*-(SR) ET-536-A*-(SR)	ET-456-A* ET-556-A*
Real-time clock Data buffer Battery Capacitor	yes Lithium battery and capacitor buffered, maintenance-free > 5 years at least 4 days			
Status display LEDs Below the back cover	for activity on - Solid state flash drive or HD - Ethernet link - COM 1 and COM 2			
Interfaces	Description			
Ethernet	Either TX or FX			
Copper (TX)	10/100Base-TX, 10/100 Mbit (Ex e) (connection X11)			
Optical fibre (FX)	100Base-FX, 100 Mbit, inherently safe (Ex op is) (connection X10)			
USB	2x Ex e (connection X5 and X7) / 2x Ex ib (connection X4 and X6)			
PS/2 (Ex ia)	For external keyboard, mouse*, trackball*, joystick* (connection X9) * not available for ET-3x6-A*			
Serial COM1	RS-232 / RS-422 / RS-485 (Ex e) (connection X2)			
Serial COM2 (optional)	RS-232 / RS-422 / RS-485 (Ex e) (connection X22)			
or				
Readers COM2 (optional)	Barcode scanner, Proximity reader interface (Ex ib) (connection X8)			
Audio	Line out output (Ex e) (connection X3)			
Fieldbus	not for Thin Client			
Operator Interface	MPI with MPI Box SSW7-RK512-RS-422			
Panel PC	MPI with MPI Box SSW7-HMI-RS-422			
	Design			
Ethernet copper (TX)	Screw terminals, 2.5 mm ² (AWG14) green			
USB (Ex e)				
PS/2 (Ex ia)				
Serial COM1 / COM2				
Readers COM2				
Audio				
USB (Ex ib)	1x USB female connector type A / 1x screw terminals, 2.5 mm ² (AWG14) green			
Ethernet optical fibre (FX)	SC duplex female connector			
Data cable / -length				
Copper (TX)	up to 100 m (330 ft) via CAT5 installation cable AWG22			
Optical fibre (FX)	up to 2000 m (6562 ft) via 62.5 / 125 µm (core- / external cross section) multi-mode optical fibre cable			
Front plate	Polyester on seawater-proof aluminium with touch technology and safety glass (standard) or Stainless steel on seawater-proof aluminium with touch-technology and safety glass, F-keys polyester			
	-	-	yes (not ET-336-A*)	yes
Housing	Stainless steel			
Housing protection type	IP66			
HMI Types	PM = PanelMount = panel mount device OS = Operator Station			
HMI Types comment	Panel mount device (PM): devices without additional enclosure (HSG) and without additional accessories Operator Station (OS): devices mounted inside additional enclosure (HSG)			
Cable glands				
Type *	8161 (Ex e)		HSK-MZ-Ex (Ex e)	
Number	5 x M16 and 1 x M20		1 x M16 and 2 x M20	
Thread size	M16 x 1.5 and M20 x 1.5			
Cable diameter range	M16 = 5 ... 9 mm / M20 = 7 ... 13 mm		M16 = 4 ... 8 mm / M20 = 10 ... 14 mm	
Width across flats	M16 = SW20 / M20 = SW24		M16 = SW19 / M20 = SW24	
* Comment	Similar certified cable glands may be used.			
* Comment a	Not used cable glands must be closed by certified screw plugs or stopping plugs !			
Breathing gland	The breathing gland is part of the enclosure and is included in the device certification.			

Function / Equipment	ET-306-A* ET-406-A*	ET-316-A* ET-416-A* ET-516-A*	ET-336-A* ET-436-A*-(SR) ET-536-A*-(SR)	ET-456-A* ET-556-A*
Operating temperature range				
Operation	-20 °C ... +55 °C* / [-4 °F ... +131 °F]			
Operation with heater *	-30 °C ... +55 °C* / [-22 °F ... +131 °F]			
Storage temperature range	-30 °C ... +60 °C / [-22 °F ... +140 °F]			
* Comment	for ET-4x6-A* and ET-5x6-A*: Operation at +55 °C / [+131 °F] for a maximum of 5 hours, at +50 °C / [+122 °F] for continuous operation (24/7)			
** Comment	The heater used must be of such a design that the temperature inside the HMI device's housing does not fall below -20 °C / [-4 °F] (-30 °C / [-22 °F] only at the front) ! Operators must ensure that the components integrated in the enclosure are only be operated when the temperatures inside the enclosure are within the permitted (certified) temperature range for these components. Further measures may be necessary.			
Heat dissipation	approx. 50 % via front plate, approx. 50 % via housing			
HMI Types comment OS	If the HMI device is installed in an additional enclosure (HSG), the upper temperature limit is reduced by 5 °C / [41 °F], due to the device's own heating and lower temperature dissipation in the additional enclosure ! Thus, the operator stations offers "only" an operation temperature range of -20 °C ... +50 °C / [-4 °F ... +122 °F] !			
Environmental conditions	level		test specification	
Relative humidity	90 % at +40 °C [+104 °F], without condensation		-	
Damp heat	+55 °C [+131 °F] / 95 % +55 °C [+131 °F] (±2 °C [+35.6 °F]) ≥95 % Location Class for humidity B		IEC 60068-2-30 : 2005 DNV	
(cyclic 2x 24 h)	+55 °C [+131 °F] / 90-100 % +20 °C [+68 °F] / 80-100 %		LR Type Approval TA 02 (2002)	
Corrosion resistant	ISA-S71.04-1985, severity level G3		EN 60068-2-60	
Vibration				
Vibration (sinus)	5 up to 13.2 Hz: ±1 mm 13,2 up to 100 Hz: ±0.7 g axis X, Y, Z 10 Hz, 1 g 450 Hz, 1 g Sweep cycle 1 oct/min Operating mode 1.2 Axis X, Y, Z		IEC 60068-2-6 : 2008 and DNV Certification No. 2.4 (2006) IEC 60068-2-6 : 2008	
Vibration / broadband random	10 Hz, 0,0100 PSD[(m/s²)²/Hz] 450 Hz, 0,0100 PSD[(m/s²)²/Hz] G _{rms} 2.11 Axis X, Y, Z		IEC 60068-2-64 : 2009	
Shock	20 impacts 20 g/11 ms		IEC 60068-2-27 : 1995	
Electromagnetic compatibility				
Immunity	According IEC 61000-6-2 (01/2005) and DIN EN 61323-1 (10/2006) for industrial areas			
Emission	According IEC 61000-6-4 (02/2011), DIN EN 55011 / CISPR 11 (03/2008) for industrial environments and DIN EN 55022 / CISPR 22 (05/2008) for Class A			
Positive pressure operation	< = 20 mbar (not SR devices)			
Dimensions [mm] / [ft]				
Front (w x h)	400 x 270 / [1.31] x [0.89]	372 x 270 / [1.22] x [0.89]	440 x 340 / [1.44] x [1.12]	535 x 425 / [1.76] x [1.39]
Cut-out w x h (+/- 0.5) / [0.0016]	385.5 x 257.5 / [1.26] x [0.84]	359.5 x 257.5 / [1.18] x [0.84]	427.5 x 327.5 / [1.40] x [1.07]	522.5 x 412.5 / [1.71] x [1.35]
Depth of cut-out	150 / [0.49]		165 / [0.54]	
Wall thickness	≤ 8 / [0.0087]			
Mounting position	vertical or horizontal			
Weight [kg] / [lbs]				
Device	13.00 / [28.66]	12.60 / [27.78]	17.30 / [38.14]	23.50 / [51.81]
Fixing frame	0.6 / [1.32]	0.6 / [1.32]	0.7 / [1.54]	0.9 / [1.98]

3.1 Additionally for ET-3x6-A-* (Operator Interfaces)

3.1.1 All devices up to hardware revision 03.02.x2

Processor	AMD Geode LX 800; 266 MHz
RAM	512 MB
Data memory	1 GB
Operating system	RT Target
Image	SPSPlus Runtime
Languages	Global, multilingual language support
Number of protocol drivers	a maximum of 4 simultaneously
Number of process images	> 1000 dynamic
Number of texts / messages	Dynamically limited by main memory
Number of variables per page	255
Number of messages	4096 fault messages, 4096 operation messages
Font sets	4 independent Windows uncondensed fonts
Configuration memory type	Flash memory

3.1.2 All devices starting from hardware revision 03.02.x5

Processor	Intel Bay Trail (BT) Atom E3815 Single Core; 1.46 GHz
RAM	2 GB
Data memory	16 GB
Type of data memory	Flash memory (Solid State Drive - SSD) (internal via CF slot)
Graphics controller	Integrated Intel Gen. 7 HD Graphics
Operating system	Windows Embedded Compact 7 (WEC7)
Image	SPSPlus Runtime (requires SPSPlusWIN V 6) Movicon CE 4096 I/O

3.1.3 All devices starting from hardware revision 03.02.x7

Type of data memory	Flash memory M.2 (Solid State Drive - SSD) (internal via SATA)
---------------------	--

3.2 Additionally for ET-4x6-A-* (Panel PC)

3.2.1 All devices up to hardware revision 03.02.x2

Processor	Intel Atom N270; 1.6 GHz
RAM	1 or 2 GB
Data memory	4 or 16 GB 128 GB MLC 128 GB SLC
Type of data memory	Flash memory (SATA)
Operating system	Windows XP Embedded / Windows XP Professional / Windows 7 Ultimate
Global language support	Via Multi-Language interface of Windows XP Embedded (25 languages)

3.2.2 All devices starting from hardware revision 03.02.x4

Processor	Intel Bay Trail (BT) Atom E3845 Quad Core; 1.91 GHz		
RAM	4 GB		
Data memory	Size	TBW	Test profile
	64 GB MLC	18.75	JESD218 Client profile
	128 GB MLC	37.5	
Type of data memory	Flash memory (Solid State Drive - SSD) (internal via CF slot)		
Graphics controller	Integrated Intel Gen. 7 HD Graphics		
Operating system	Windows Embedded Standard 7 / Windows 7 Ultimate		
	Windows 10 IoT Enterprise 2016 LTSB (64 bit) (included in standard delivery)		
	Windows 10 IoT Enterprise 2016 LTSB (32 bit) (optional on USB stick)		
Global language support	Via Windows operating system		

3.2.3 All devices starting from hardware revision 03.02.x6

Type of data memory	Flash memory M.2 (Solid State Drive - SSD) (internal via SATA)
---------------------	--

3.3 Additionally for ET-5x6-A-* (Thin Clients)

3.3.1 All devices up to hardware revision 03.02.x2

Processor	AMD Geode LX 800; 266 MHz
RAM	512 MB
	2 GB *
Data memory	1 GB
	16 GB *
Operating system	Windows Embedded Standard 2009 and Remote Firmware
	Windows Embedded Standard 7, Remote Firmware and Delta V *

NOTICE	* The combination of 2 GB RAM with 16 GB data memory is only available for the operating system with Delta V !
---------------	--

3.3.2 All devices starting from hardware revision 03.02.x4

Processor	Intel Bay Trail (BT) Atom E3845 Quad Core; 1.91 GHz
RAM	4 GB
Data memory	64 GB
Type of data memory	Flash memory (Solid State Drive - SSD) (internal via CF slot)
Graphics controller	Integrated Intel Gen. 7 HD Graphics
Operating system	Windows 10 IoT Enterprise and Remote Firmware

3.3.3 All devices starting from hardware revision 03.02.x6

Data memory	Size	TBW	Test profile
	64 GB MLC	18.75	JESD218 Client profile
	128 GB MLC	37.5	
Type of data memory	Flash memory M.2 (Solid State Drive - SSD) (internal via SATA)		

4 Conformity to standards

The ET-xx6-A-* HMI devices comply with the following standards and directives:

Standard	Classification
2nd supplement	
ATEX directive 2014/34/EU	
IEC 60079-0 : 2011	General requirements
IEC 60079-1 : 2007	Flameproof enclosure "d"
IEC 60079-7 : 2006	Increased safety "e"
IEC 60079-11 : 2011	Intrinsic safety "i"
IEC 60079-18 : 2009	Encapsulation "m"
IEC 60079-28 : 2006	Optical radiation "op is"
IEC 60079-31 : 2008	Protected by enclosures "t" (dust)
The product corresponds to requirements from:	
EN 60079-0 : 2012 + A11 : 2013	General requirements
EN 60079-1 : 2014	Flameproof enclosure "d"
EN 60079-7 : 2007	Increased safety "e"
EN 60079-7 : 2015 (from 01.08.2018)	
EN 60079-11 : 2012	Intrinsic safety "i"
EN 60079-18 : 2015	Encapsulation "m"
EN 60079-28 : 2015	Optical radiation "op is"
EN 60079-31 : 2014	Protected by enclosures "t" (dust)

Electromagnetic compatibility	
EMC directive	
2014/30/EU	Classification
EN 61326-1 : 2013	General requirements
EN 61000-6-2 : 2006	Immunity
EN 61000-6-4 : 2007 + A1 2011	Emission
RoHS directive	
2011/65/EU	Classification
EN 50581 : 2012	Technical documentation for the assessment of electrical and electronic products with respect to the restriction of hazardous substances

5 Certificates

The ET-xx6-A-* HMI devices are certified for installation in the following areas:

Europe:

according to ATEX Directive
for installation in zones 1, 2, 21 and 22

International / Australia:

IECEX (International Electrotechnical Commission System for Certification to Standards for Electrical Equipment for Explosive Atmospheres)

Russia / Kazakhstan / Belarus:

EAC (TR) (Technical Regulation of the Eurasian Customs Union)

India:

PESO (Ministry of Commerce & Industry, Petroleum and Explosives Safety Organisation)

China:

according to CNEX
carried out by:
CQST (China National Quality Supervision and Test Centre for Explosion Protected Electrical Products)

Marine certification:

DNV / GL (Det Norske Veritas / Germanischer Lloyd)
ABS (American Bureau of Shipping)
LR (Lloyd's Register)

5.1 ATEX

The ATEX certificate is listed under the following certification number:

Certificate number: TÜV 11 ATEX 7041 X

5.2 IECEX

The IECEX certificate is listed under the following certification number:

Certificate number: IECEX TUR 11.0006X

 DOCUMENTATION	<p>You can access all IECEX certificates on the official website of the IEC under their certificate number. http://iecex.iec.ch/iecex/iecexweb.nsf/welcome?openform.</p>
--	---

5.3 EAC (TR)

The EAC (TR) certification is listed under the following certificate number:

Certificate number: EA3C RU C-DE.HA91.B.00085/19

5.4 PESO

The PESO certification is listed under the following certificate number:

Certificate number: A/P/HQ/MH/104/5004(P391127)
CCE identification number: P391127/1

5.5 CNEX

The CNEX certification is listed under the following certificate number:

Certificate number: CNEx18.5523X

5.6 DNV / GL

The DNV / GL certification is listed under the following certificate numbers:

Certificate number: TAA00000WA

5.7 ABS

The ABS (American Bureau of Shipping) certification is listed under the following certificate number:



Certificate number: 15-HG1418766-1-PDA

5.8 LR

The LR certification is listed under the following certificate number:

Certificate number: 11/20035 (E1)

6 Marking

Manufacturer	R. STAHL HMI Systems GmbH	
Type code	ET-3x6-A-* / ET-4x6-A-* / ET-5x6-A-*	
CE classification:	 0158	
Testing authority and certificate number:	TÜV 11 ATEX 7041 X IECEX TUR 11.0006X	
Ex classification:		
ATEX directive ET-xx6-A-TX		II 2 (2) G Ex d e ia ib mb [ia ib] IIC T4 Gb from 01.08.2018 II 2 (2) G Ex db eb ia ib mb [ia ib] IIC T4 Gb II 2 (2) D Ex ia tb [ia ib] IIIC T80°C Db IP66
ET-xx6-A-FX		II 2 (2) G Ex d e ia ib mb [ia ib op is] IIC T4 Gb from 01.08.2018 II 2 (2) G Ex db eb ia ib mb [ia ib op is] IIC T4 Gb II 2 (2) D Ex ia tb [ia ib op is] IIIC T80°C Db IP66
IECEX ET-xx6-A-TX		Ex d e ia ib mb [ia ib] IIC T4 Gb from 01.08.2018 Ex db eb ia ib mb [ia ib] IIC T4 Gb Ex ia tb [ia ib] IIIC T80°C Db IP66
ET-xx6-A-FX		Ex d e ia ib mb [ia ib op is] IIC T4 Gb from 01.08.2018 Ex db eb ia ib mb [ia ib op is] IIC T4 Gb Ex ia tb [ia ib op is] IIIC T80°C Db IP66
EAC (TR) ET-xx6-A-TX		1Ex d e ia ib mb [ia ib] IIC T4 Gb X Ex ia tb [ia ib] IIIC T80°C Db
ET-xx6-A-FX		1Ex d e ia ib mb [ia ib op is] IIC T4 Gb X Ex ia tb [ia ib op is] IIIC T80°C Db
PESO		Ex d e ia ib mb [ia ib] IIC T4 Gb
CNEX ET-xx6-A-TX		Ex d e ia ib mb [ia ib] IIC T4 Gb Ex ia tb [ia ib] IIIC T80°C Db IP66
ET-xx6-A-FX		Ex d e ia ib mb [ia ib op is] IIC T4 Gb Ex ia tb [ia ib op is] IIIC T80°C Db IP66

7 Power supply

7.1 HMI devices

Power supply: 24.0 VDC
(min. 20.4 VDC , max. 28.8 VDC / (-15 % / +20 %))
Up from 100 GB data memory (min. 21.6 VDC , max. 28.8 VDC / (-10 % / +20 %))

Power consumption: 1.2 A

7.1.1 HMI device terminals

Copper wires with cross sections of between 0.2 mm² (AWG24) and 2.5 mm² (AWG14) may be connected to any of the terminals of the HMI devices.

NOTICE

When connecting cables to the terminals please make sure that the insulation of the cables goes right up to the terminal contacts.

7.1.1.1 Tightening torque

For the terminals X1 and X11 a tightening torque of:

0,4 Nm up to 0,5 Nm is valid

and for the terminals X2, X22, X3, X4, X5, X6, X7, X8 and X9 a tightening torque of:

0,5 Nm bis 0,6 Nm is valid.

NOTICE

The stipulated tightening torques of the connection terminals must be observed and applied. Again, they must be checked and possibly adjusted before commissioning !

8 Permitted maximum values

8.1 External, non-intrinsically safe circuits

Input voltage (X1):

Rated voltage	24 VDC (+20% / -15%)
Power consumption at U_{rated}	1.5 A max
max. working voltage U_m	30 VDC

RS-422/-232 COM1 (X2):

Rated voltage	RS-422: 5 VDC	RS-232: ± 12 VDC
Max. operating voltage U_m	253 VAC	

RS-422/-232 COM2 (X22):

Rated voltage	RS-422: 5 VDC	RS-232: ± 12 VDC
Max. operating voltage U_m	253 VAC	

USB-1 (X5):

Rated voltage	5 VDC
Max. operating voltage U_m	253 VAC

USB-3 (X7):

Rated voltage	5 VDC
Max. operating voltage U_m	253 VAC

Copper Ethernet (X11):

Rated voltage	5 VDC
Rated power	100 mW
Max. operating voltage U_m	30 VDC

Audio (X3):

Rated voltage	5 VDC
Max. operating voltage U_m	253 VAC

8.2 External inherently safe optical interface

Ethernet optical fiber (X10):

Wavelength	1350 nm
Radiant power	≤ 35 mW

8.3 External intrinsically safe circuits

USB0 (X4):

The maximum values for group IIC are:

U_i	=	-	V	U_o	=	5.9	V				
I_i	=	-	mA	I_o	=	2.69	A				
P_i	=	-	mW	P_o	=	6.02	W				
C_i	=	0	μF	C_o	=	5.1	11	28	40	μF	
L_i	=	0	mH	L_o	=	10	5	2	1	μH	

C_o and L_o pairs directly above/underneath each other may be used.

The maximum values for group IIB are:

U_i	=	-	V	U_o	=	5.9	V				
I_i	=	-	mA	I_o	=	2.69	A				
P_i	=	-	mW	P_o	=	6.02	W				
C_i	=	0	μF	C_o	=	14	40	79	200	μF	
L_i	=	0	mH	L_o	=	50	20	10	5	μH	

C_o and L_o pairs directly above/underneath each other may be used.

USB-2 (X6):

The maximum values for group IIC are:

U_i	=	-	V	U_o	=	5.9	V				
I_i	=	-	mA	I_o	=	2.69	A				
P_i	=	-	mW	P_o	=	6.02	W				
C_i	=	0	μF	C_o	=	5.1	11	28	40	μF	
L_i	=	0	mH	L_o	=	10	5	2	1	μH	

C_o and L_o pairs directly above/underneath each other may be used.

The maximum values for group IIB are:

U_i	=	-	V	U_o	=	5.9	V				
I_i	=	-	mA	I_o	=	2.69	A				
P_i	=	-	mW	P_o	=	6.02	W				
C_i	=	0	μF	C_o	=	14	40	79	200	μF	
L_i	=	0	mH	L_o	=	50	20	10	5	μH	

C_o and L_o pairs directly above/underneath each other may be used.

Reader RSi1 (X8) +U_i 1 (power supply circuit, X8.0, bridge to X8.2):

U _o	=	10.4	V
I _o	=	220	mA
P _o	=	2.29	W
C _o	=	0.08	μF
L _o	=	0.01	mH

Reader RSi1 (X8) +U_{ex1} (power supply circuit, X8.2, bridge from X8.0):

U _i	=	12.4	V
I _i	=	220	mA
P _i	=	2.29	mW
C _i	=	25	nF
L _i	=	0	mH

Reader RSi1 (power supply reader, X8.3-4):

The maximum values for group IIC are:

U _i	=	-	V	U _o	=	5.36	V	
I _i	=	-	mA	I _o	=	220	mA	
P _i	=	-	W	P _o	=	1.18	W	
C _i	=	5.3	μF	C _o	=	40.7	59.7	μF
L _i	=	0	mH	L _o	=	2	1	μH

C_o and L_o pairs directly above/underneath each other may be used.

The maximum values for group IIB are:

U _i	=	-	V	U _o	=	5.36	V	
I _i	=	-	mA	I _o	=	220	mA	
P _i	=	-	W	P _o	=	1.18	W	
C _i	=	5.3	μF	C _o	=	70.7	124.7	μF
L _i	=	0	mH	L _o	=	20	10	μH

C_o and L_o pairs directly above/underneath each other may be used.

Reader RSi1 and RSi2 (signal input / output, X8.5-8):

The maximum values for group IIC are:

U _i	=	15	V	U _o	=	5.36	V
I _i	=	500	mA	I _o	=	46	mA
P _i	=	2.5	W	P _o	=	62	mW
C _i	=	0	μF	C _o	=	46	μF
L _i	=	0	mH	L _o	=	2	μH

The maximum values for group IIB are:

U _i	=	15	V	U _o	=	5.36	V
I _i	=	500	mA	I _o	=	46	mA
P _i	=	2.5	W	P _o	=	62	mW
C _i	=	0	μF	C _o	=	79	μF
L _i	=	0	mH	L _o	=	20	mH

Reader WCR1 (X8) (connection voltage supply, X8.1-2):

U_i	=	11.4	V
I_i	=	200	mA
P_i	=	2.28	W
C_i	=	25	nF
L_i	=	0	mH

Reader WCR1 (power supply reader, X8.3-4):

The maximum values for group IIC are:

U_i	=	-	V	U_o	=	5.88	V
I_i	=	-	mA	I_o	=	200	mA
P_i	=	-	mW	P_o	=	1.18	W
C_i	=	5.3	μ F	C_o	=	27.7	37.7 μ F
L_i	=	0	mH	L_o	=	2	1 μ H

C_o and L_o pairs directly above/underneath each other may be used.

The maximum values for group IIB are:

U_i	=	-	V	U_o	=	5.88	V
I_i	=	-	mA	I_o	=	200	mA
P_i	=	-	mW	P_o	=	1.18	W
C_i	=	5.3	μ F	C_o	=	55.7	94.7 μ F
L_i	=	0	mH	L_o	=	20	10 μ H

C_o and L_o pairs directly above/underneath each other may be used.

Reader WCR1 and WCR2 (signal input / output, X8.5-8):

The maximum values for group IIC are:

U_i	=	15	V	U_o	=	5.88	V
I_i	=	500	mA	I_o	=	51	mA
P_i	=	2.5	W	P_o	=	75	mW
C_i	=	0	μ F	C_o	=	34	μ F
L_i	=	0	mH	L_o	=	2	μ H

The maximum values for group IIB are:

U_i	=	15	V	U_o	=	5.88	V
I_i	=	500	mA	I_o	=	51	mA
P_i	=	2.5	W	P_o	=	75	mW
C_i	=	0	μ F	C_o	=	63	μ F
L_i	=	0	mH	L_o	=	20	μ H

PS2 interface (X9):

Connection for keyboard, mouse, trackball, joystick

The maximum values for group IIC are:

U _i	=	-	V		U _o	=	5.88	V	
I _i	=	-	mA		I _o	=	200	mA	
P _i	=	-	mW		P _o	=	1.18	W	
C _i	=	17.6	μF		C _o	=	15.4	25.4	μF
L _i	=	0	mH		L _o	=	2	1	μH

C_o and L_o pairs directly above/underneath each other may be used.

The maximum values for group IIB are:

U _i	=	-	V		U _o	=	5.88	V			
I _i	=	-	mA		I _o	=	200	mA			
P _i	=	-	mW		P _o	=	1.18	W			
C _i	=	17.6	μF		C _o	=	10.4	20.4	43.4	82.4	μF
L _i	=	0	mH		L _o	=	100	50	20	10	μH

C_o and L_o pairs directly above/underneath each other may be used.

! ATTENTION

Do **NOT** connect the optional external keyboard to live equipment !

9 Type code

9.1 Certificate

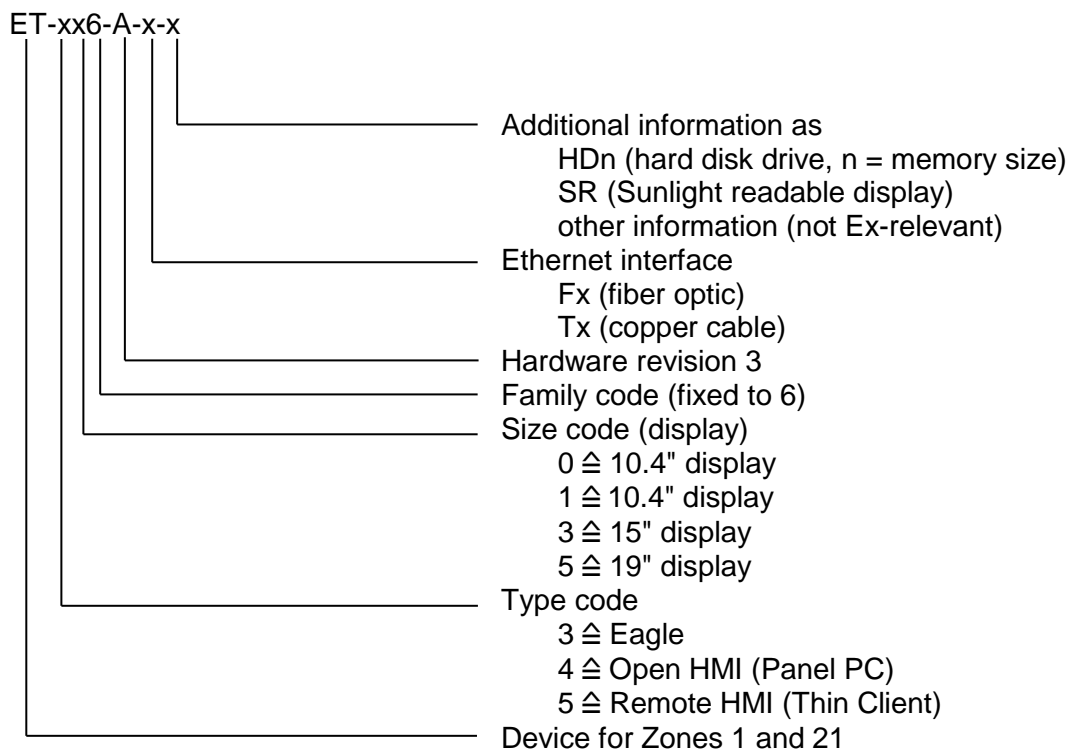

9.2 Order variant

9.2.1 ET-3x6-A (Operator Interfaces)

! NOTICE	These versions apply to all Operator Interfaces up to hardware revision 03.02.x2, with AMD Geode LX processor.
-----------------	--

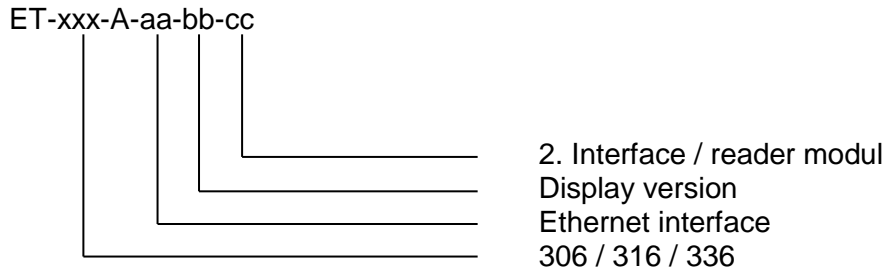

Device variant:

Classification product key	Description
	Type with
ET-3x6-A- FX -bb-cc	Optical fiber Ethernet interface 100Base-FX (Ex op is)
ET-3x6-A- TX -bb-cc	Copper Ethernet interface 10/100Base-TX (Ex e)
ET-3x6-A-aa- TFT -cc	TFT Display (Standard)
ET-3x6-A-aa- SR -cc	Sunlight readable Display 1000 cd/m ² (only ET-336-A)
ET-3x6-A-aa-bb- RS2	2. serial interface (RS-232/RS-422/RS-485) (Ex e) (optional) *
ET-3x6-A-aa-bb- RSi1	Plug-in module for reader with RS-232 interface *, power supply via HMI device

! NOTICE	* Either the optional second serial interface or a plug-in module for readers can be used / ordered.
-----------------	--

9.2.2 ET-3x6-A-*-BS (Operator Interfaces)

NOTICE These versions apply to all Operator Interfaces starting from hardware revision 03.02.x5, with Bay Trail Atom E3815 processor.

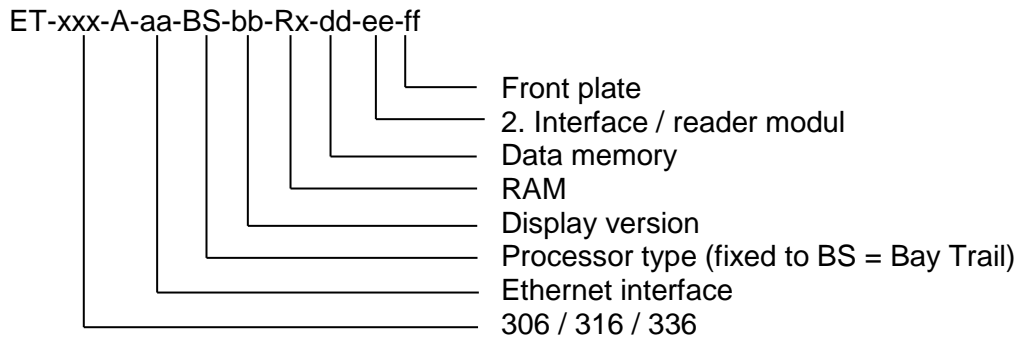

Device variant:

Classification product key	Description
	Type with
ET-3x6-A- FX -BS-bb-Rx-dd-ee-ff	Optical fiber Ethernet interface 100Base-FX (Ex op is)
ET-3x6-A- TX -BS-bb-Rx-dd-ee-ff	Copper Ethernet interface 10/100Base-TX (Ex e)
ET-3x6-A-aa-BS- TFT -Rx-dd-ee-ff	TFT Display (Standard)
ET-3x6-A-aa-BS- SR -Rx-dd-ee-ff	Sunlight readable Display 1000 cd/m ² (only ET-336-A-*-BS) (no longer available)
ET-3x6-A-aa-BS-bb- R2 -dd-ee-ff	2 GB RAM
ET-3x6-A-aa-BS-bb-Rx- 16GB -ee-ff	16 GB Solid State Drive
ET-3x6-A-aa-BS-bb-Rx-dd- RS2 -ff	2. serial interface (RS-232/RS-422/RS-485) (Ex e) (optional) *
ET-3x6-A-aa-BS-bb-Rx-dd- RSi1 -ff	Plug-in module for reader with RS-232 interface *, power supply via HMI device
ET-3x6-A-aa-BS-bb-Rx-dd-ee- PES	Polyester front plate

NOTICE * Either the optional second serial interface or a plug-in module for readers can be used / ordered.

9.2.3 ET-4x6-A (Panel PC)

! NOTICE	These versions apply to all Panel PC's up to hardware revision 03.02.x2, with Atom N270 processor.
-----------------	--

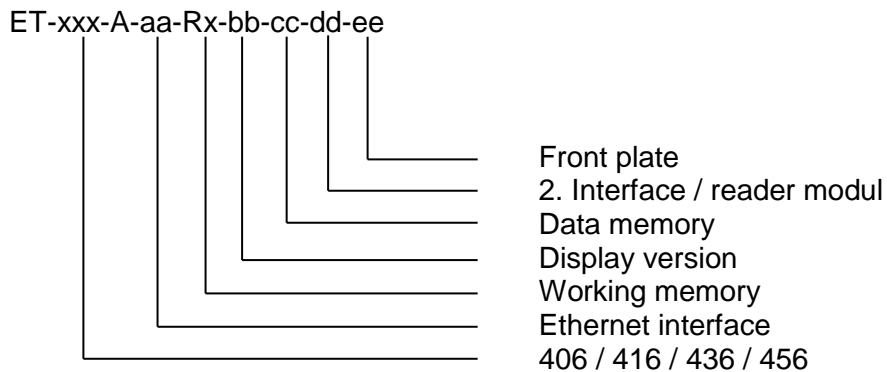

Device variant:

Classification product key	Description
	Type with
ET-4x6-A- FX -Rx-bb-cc-dd-ee	Optical fiber Ethernet interface 100Base-FX (Ex op is)
ET-4x6-A- TX -Rx-bb-cc-dd-ee	Copper Ethernet interface 10/100Base-TX (Ex e)
ET-4x6-A-aa- R1 -bb-cc-dd-ee	RAM memory 1 GB
ET-4x6-A-aa- R2 -bb-cc-dd-ee	RAM memory 2 GB
ET-4x6-A-aa-Rx- TFT -bb-cc-dd-ee	TFT display (standard)
ET-4x6-A-aa-Rx- SR -bb-cc-dd-ee	Sunlight readable display 1000 cd/m ² (ET-436-A only)
ET-4x6-A-aa-Rx-bb- 4GB -dd-ee	4 GB Solid State Drive (SSD)
ET-4x6-A-aa-Rx-bb- 16GB -dd-ee	16 GB Solid State Drive (SSD)
ET-4x6-A-aa-Rx-bb- 128GBM -dd-ee	128 GB Solid State Drive MLC
ET-4x6-A-aa-Rx-bb- 128GBS -dd-ee	128 GB Solid State Drive SLC
ET-4x6-A-aa-Rx-bb-cc- RS2 -ee	2. serial interface (RS-232/RS-422/RS-485) (Ex e) (optional) *
ET-4x6-A-aa-Rx-bb-cc- RSi1 -ee	Plug-in module for reader with RS-232 interface *, power supply via HMI device
ET-4x6-A-aa-Rx-bb-cc-dd- PES	Polyester front plate
ET-4x6-A-aa-Rx-bb-cc-dd- VA	Stainless steel front plate (436 and 456 only), NOT SR type

! NOTICE	* Either the optional second serial interface or a plug-in module for readers can be used / ordered.
-----------------	--

9.2.4 ET-4x6-A-*-BT (Panel PC)

NOTICE	These versions apply to all Panel PC's starting from hardware revision 03.02.x4, with Bay Trail Atom E3845 processor.
---------------	---

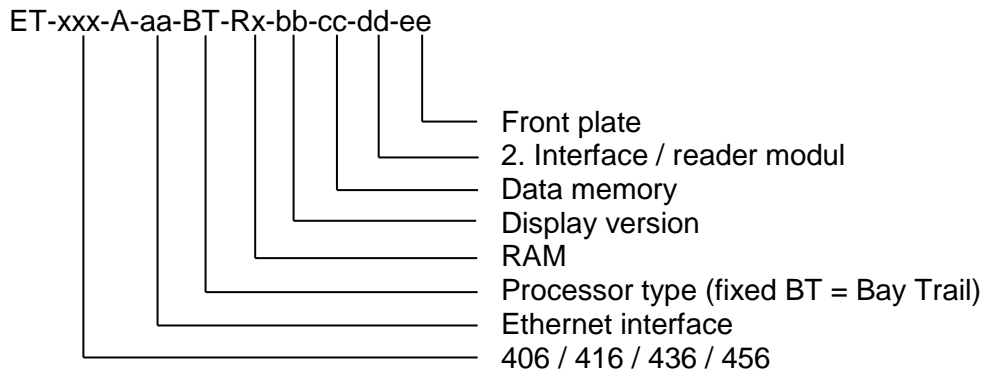

Device variant:

Classification product key	Description
	Type with
ET-4x6-A- FX -BT-Rx-bb-cc-dd-ee	Optical fiber Ethernet interface 100Base-FX (Ex op is)
ET-4x6-A- TX -BT-Rx-bb-cc-dd-ee	Copper Ethernet interface 10/100Base-TX (Ex e)
ET-4x6-A-aa-BT- R3 -bb-cc-dd-ee	RAM 4 GB
ET-4x6-A-aa-BT-Rx- TFT -bb-cc-dd-ee	TFT display (standard)
ET-4x6-A-aa-BT-Rx- SR -bb-cc-dd-ee	Sunlight readable display 1000 cd/m ² (ET-436-A-*-BT only) (no longer available)
ET-4x6-A-aa-BT-Rx-bb- 64GB -dd-ee	64 GB Solid State Drive (SSD)
ET-4x6-A-aa-BT-Rx-bb- 128GBM -dd-ee	128 GB Solid State Drive MLC
ET-4x6-A-aa-BT-Rx-bb-cc- RS2 -ee	2. serial interface (RS-232/RS-422/RS-485) (Ex e) (optional) *
ET-4x6-A-aa-BT-Rx-bb-cc- RSi1 -ee	Plug-in module for reader with RS-232 interface *, power supply via HMI device
ET-4x6-A-aa-BT-Rx-bb-cc-dd- PES	Polyester front plate
ET-4x6-A-aa-BT-Rx-bb-cc-dd- VA	Stainless steel front plate (436 and 456 only), NOT SR type

NOTICE	* Either the optional second serial interface or a plug-in module for readers can be used / ordered.
---------------	--

9.2.5 ET-5x6-A (Thin Client)

 NOTICE	These versions apply to all Thin Client's up to hardware revision 03.02.x2, with AMD Geode LX processor.
---	--

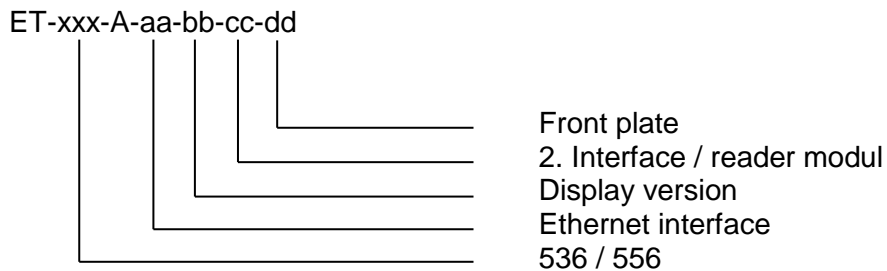

Device variant:

Classification product key	Description
	Type with
ET-5x6-A- FX -bb-cc-dd	Optical fiber Ethernet interface 100Base-FX (Ex op is)
ET-5x6-A- TX -bb-cc-dd	Copper Ethernet interface 10/100Base-TX (Ex e)
ET-5x6-A-aa- TFT -cc-dd	TFT display (standard)
ET-5x6-A-aa- SR -cc-dd	Sunlight readable display 1000 cd/m ² (ET-536-A only)
ET-5x6-A-aa-bb- RS2 -dd	2. serial interface (RS-232/RS-422/RS-485) (Ex e) (optional) *
ET-5x6-A-aa-bb- RSi1 -dd	Plug-in module for reader with RS-232 interface* , power supply via HMI device
ET-5x6-A-aa-bb- RSi2 -dd	Plug-in module for reader with RS-232 interface * , power supply of the reader externally
ET-5x6-A-aa-bb-cc- PES	Polyester front plate
ET-5x6-A-aa-bb-cc- VA	Stainless steel front plate, NOT SR type

 NOTICE	* Either the optional second serial interface or a plug-in module for readers can be used / ordered.
---	--

9.2.6 ET-5x6-A-*-BT (Thin Client)

 NOTICE	These versions apply to all Thin Client's starting from hardware revision 03.02.x4, with Bay Trail Atom E3845 processor.
---	--

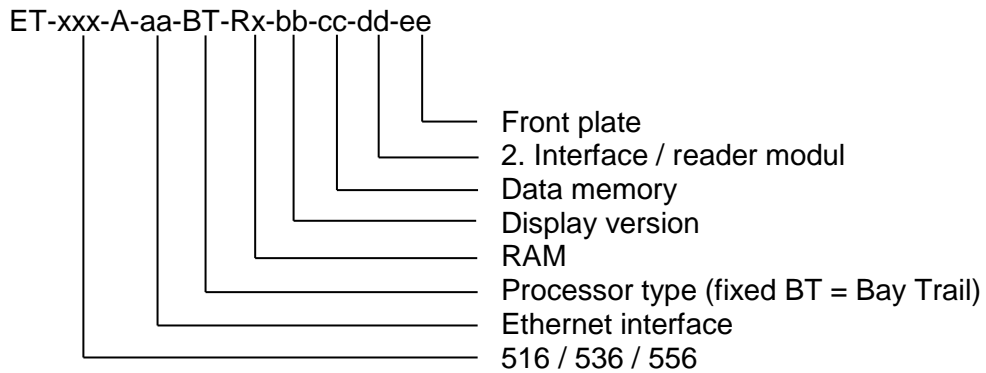



Device variant:

Classification product key	Description
	Type with
ET-5x6-A- FX -BT-Rx-bb-cc-dd-ee	Optical fiber Ethernet interface 100Base-FX (Ex op is)
ET-5x6-A- TX -BT-Rx-bb-cc-dd-ee	Copper Ethernet interface 10/100Base-TX (Ex e)
ET-5x6-A-aa-BT- R3 -bb-cc-dd-ee	RAM 4 GB
ET-5x6-A-aa-BT-Rx- TFT -bb-cc-dd-ee	TFT display (standard)
ET-5x6-A-aa-BT-Rx- SR -bb-cc-dd-ee	Sunlight readable display 1000 cd/m ² (ET-536-A-*-BT only) (no longer available)
ET-5x6-A-aa-BT-Rx-bb- 64GB -dd-ee	64 GB Solid State Drive (SSD)
ET-5x6-A-aa-BT-Rx-bb- 128GB -dd-ee	128 GB Solid State Drive (SSD)
ET-5x6-A-aa-BT-Rx-bb-cc- RS2 -ee	2. serial interface (RS-232/RS-422/RS-485) (Ex e) (optional) *
ET-5x6-A-aa-BT-Rx-bb-cc- RSi1 -ee	Plug-in module for reader with RS-232 interface *, power supply via HMI device
ET-5x6-A-aa-BT-Rx-bb-cc-dd- PES	Polyester front plate
ET-5x6-A-aa-BT-Rx-bb-cc-dd- VA	Stainless steel front plate, NOT SR type

 NOTICE	* Either the optional second serial interface or a plug-in module for readers can be used / ordered.
---	--

10 Safety Advice

 NOTICE	<p>This chapter is a summary of the key safety measures. The summary is supplementary to existing rules which staff also have to study.</p>
	<p>The safety of persons and equipment in hazardous areas depends on compliance with all relevant safety regulations. Thus, the installation and maintenance staff carry a particular responsibility, requiring precise knowledge of the applicable regulations and conditions.</p>

 CAUTION	<p>The notes listed below in section 10.1 must be heeded to avoid injury and damage to equipment !</p>
--	--

10.1 Installation and operation

Please note the following when installing and operating the device:

- The in each case valid national regulations for installation and assembly apply (e.g. IEC/EN 60079-14).
- The HMI device has been certified as a fixed installed device. It must be fixed with a bracket or be secured in another way at a specified position.
- The HMI device must be disconnected from the mains for a change of position. The EPL must be adhered to.
- The HMI device must only be switched on when it is closed.
- The HMI device may be installed in zones 1, 2, 21 or 22.
- The intrinsically safe circuits must be installed according to applicable regulations.
- When installed in zones 1, 2, 21 and 22, intrinsically safe devices suitable for categories 2G, 3G, 2D and 3D may be connected to the intrinsically safe power supply circuits.
- If the HMI devices are installed in areas exposed to the risk of dust explosions, the maximum values of Group IIB apply to the intrinsically safe circuits.
- Interconnecting several active devices in an intrinsically safe circuit may result in different safe maximum values. This could compromise intrinsic safety !
- The safe maximum values of the connected field device(s) must correspond to the values listed on the data sheet or the EC type examination certificate.
- During assembly and operation of the HMI device electrostatic surface charging must not exceed that caused by manual rubbing.
- After switching the HMI device off, wait for at least 1 minute before opening it.
- Before opening the housing lid users must ensure that all non-intrinsically safe circuits have been switched off. Circuits supplied from different sources may be connected ! Please note that all associated equipment (such as the SK-KJ1710, for example) must also be switched off !
- The HMI device and any connected equipment must be incorporated into the same potential equalization system (see installation example in the Hardware Manual). An alternative would be to connect only devices that are safely isolated from earth potential.

- National safety and accident prevention rules.
- Generally accepted technical rules.
- Safety instructions contained in these operating instructions.
- Any damage may compromise the explosion protection !

Use the device for its intended purpose only (see "Device Function").

Incorrect or unauthorized use and non-compliance with the instructions in this manual will void any warranty on our part.

No changes to the device that compromise its explosion protection are permitted !

The device may only be installed and operated in an undamaged, dry and clean condition !

10.2 Cautionary notes



This is an EN 55022 Class A product.

In a domestic environment this product may cause radio interference in which case the user may be required to take adequate measures.

10.3 Special conditions



The fronts of the HMI devices with a sunlight readable display (type code includes "SR") may be cleaned with a damp cloth only.

11 Installation

11.1 General information

 NOTICE	<p>Electrical plants are subject to certain regulations concerning installation and operation (e.g. RL 1999/92/EC, RL 2014/34/EU and IEC/EN 60079-14).</p>
	<p>It is the responsibility of the operators of electrical installations in hazardous environments to ensure that the equipment is kept in proper condition, is operated according to instructions and that maintenance and repairs are carried out.</p>

11.2 ET-xx6-A-*

- Operators must ensure compliance with the examination certificates before installation. Users must adhere to any “special conditions” therein. Also of importance are the maximum electrical operating values specified therein.
- The earth / ground (PE) connector at the back of the HMI device housing must be connected to the equipotential bonding conductor of the hazardous area. The earthing cable's cross section must be at least 4 mm² (AWG12) and it must be fitted with a suitable cable lug. To prevent equalizing currents flowing to the earth / ground (PE) system of the HMI device it is necessary to safely isolate any connected devices from earth or to integrate them into the earth / ground (PE) system of the HMI device.
- The PE connection part of the HMI device located at the back of the housing is internally connected with the GND supply cable (X1 pins 3 and 4).
- The HMI devices can be mounted and operated in any position. Sufficient air circulation must be ensured, however, so that the maximum operating temperature is not exceeded.
- Intrinsically safe and non intrinsically safe conducting connection parts must be installed with a minimum distance of 50 mm [0.16 ft].
- When connecting the HMI devices to the intrinsically safe circuits of the associated equipment the respective maximum values of the field unit and the associated equipment must be observed to ensure explosion protection (proof of intrinsic safety).
- The HMI device's front should be protected by a canopy against permanent exposure to UV light. This increases the front membrane's lifespan. The canopy **MUST NOT** be too close to the front plate and sufficient air circulation must be ensured.
- The ET-4x6-A-* and ET-5x6-A-* devices may be operated at + 55°C [+131 °F] **ONLY FOR SHORT PERIODS** (maximum 5 h) at a time.

11.2.1 HMI device Installation in housings type of protection "e" or "t"

If the HMI devices ET-xx6-A-* are mounted inside a cut out of a suitable housing of protection type Ex e or Ex t, its mechanical protection regarding impact and IP code protection up to IP65 is maintained even after the device has been installed. The internal separation requirements and the temperature assessment of the Ex e housing must be in accordance with the applicable standards. The clearance of HMI device terminals to other bare conducting parts (excepting ground) inside the Ex e housing shall be at least 50 mm [0.16 ft].

11.2.2 Cable glands

- The enclosures of HMI devices are fitted with type STAHL 8161/* and type HSK-MZ-Ex cable glands. These are certified for installation in zone 1 and 21 and correspond to the temperature range of the device.
- Unused cable glands must be closed with certified screw plugs or stopping plugs.
- Open enclosure holes without cable glands are not permitted and must be closed with a certified screw plug. This certified screw plug must have an equal or higher area of certification (zone) and permitted temperature range, and the same country approval (e.g. ATEX for Europe) as the HMI device.
- Alternative, similar and certified cable glands may be used provided they have an equal or higher area of certification (zone) and permitted temperature range, and the same country approval (e.g. ATEX for Europe) as the HMI device.

The tightening torques for the cable glands may vary depending on the cables and wires used. The users have to determine and apply the required torques themselves. In the case of ex-factory systems, all components are installed correctly and in accordance with applicable standards. Since storage or temperature etc. can have an impact on the cables and cable glands, the pre-installed screw connections must be checked and possibly tightened before commissioning.

If they are too loose or too tight, the type of protection, sealing or strain relief might be negatively impacted.

Cable glands with cap nut and without strain relief clamp should only be used for permanently installed cables and electrical lines. Installation of the required strain relief is the responsibility of the system set-up engineer.

11.3 Usage of the USB-interfaces

Hardware and connection				
connection to	intrinsic safety USB devices		intrinsically safe equipment	
	safe area	hazardous areas	safe area	hazardous areas
X4 (I.S.)	x	-	-	-
X6 (I.S.)	-	via VB-USB-Plug	-	-
X5 (Ex e)	-		via VB-USB-INST1	explosion-proof, but not intrinsically safe devices
X7 (Ex e)				
Functionality and application				
ET-3x6-A-*	Project transfer (SPSPPlusWIN project)		-	corresponding device function *
	Device back-up		-	
ET-4x6-A-*	Restore factory state		Software installations	
	Creation of User / OEM back-up		-	
	Software installations		-	
ET-5x6-A-*	Restore factory state		-	
	Import / Export parameters		-	

 DOCUMENTATION	* See also 11.4.2.1 Connection variations for Ex e USB interfaces
---	---

11.3.1 Usage of USB Memory-Sticks

 ATTENTION	Only USB memory sticks that are certified according to IEC/EN 60079-11 may be used !
--	--

 NOTICE	In an industrial area, a permitted, explosion proof memory stick may be connected to the I.S. USB interface of the HMI device after having been connected to any PC.
---	--

If devices are connected to the I.S. USB interface that have not been approved by R. STAHL HMI Systems GmbH, protective elements may become damaged, thus compromising the intrinsic safety of the interfaces.

In this case R. STAHL HMI Systems can no longer guarantee the intrinsic safety of the device !

11.3.2 Usage of external USB devices

 NOTICE	Not applicable to ET-5x6-A-*
---	------------------------------

Software may be installed with the aid of any external USB devices subject to the following conditions:

- The software is installed in the safe area.
- The USB devices are connected to the Ex e USB interfaces USB1 or USB3 (X5 or X7) with the VB-USB-INST1 connection cable.

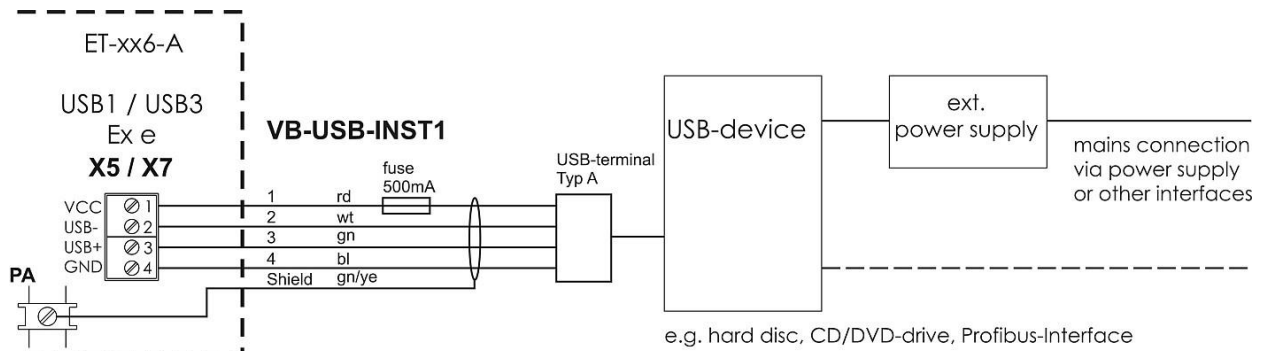

Connection diagram with VB-USB-INST1 (hard disk, CD / DVD with power supply)

 ATTENTION	Direct connections to the HMI devices must be via VB-USB-INST1 ! Otherwise, the internal circuits may become damaged and the explosion-protection of the HMI device may become compromised !
--	---

11.4 USB interfaces

The ET-xx6-A-* device series have 4 USB interface channels.

- USB0 at X4 for the internal connection of a USB Drive.
- USB1 at X5 for the connection of external USB devices.
- USB2 at X6 for the connection of an external USB Drive.
- USB3 at X7 for the connection of external USB devices.

 DOCUMENTATION	The connection diagram for the ET-xx6-A-* interfaces can be found in chapter 13.2 connections .
--	---

11.4.1 I.S. USB interfaces USB0, USB2

The USB0 and USB2 I.S. interfaces (X4 and X6) are intended for the internal or external connection of USBi Drives.

The maximum value for the joint power supply of USB0 and USB2 is 500 mA.

11.4.2 Ex e USB interfaces USB1, USB3

The USB1 and USB3 Ex e USB interfaces (X5 and X7) are intended for the connection of external USB devices.

The maximum value for the joint power supply of USB1 and USB3 is 500 mA.

11.4.2.1 Connection variations for Ex e USB interfaces

The two Ex e USB interfaces have an identical structure. The X5 (USB 1) and X7 (USB 3) terminals are for the connection of devices that can be both intrinsically safe or not intrinsically safe.

 ATTENTION	If intrinsically safe devices are connected to the Ex e USB interfaces of the ET-xx6-A-* HMI devices, R. STAHL Systems GmbH cannot guarantee that the intrinsic safety of these devices will continue to apply !
--	--

The following versions are possible:

1. If a USB device that is not connected to the mains is connected, voltage can be supplied from the internal power supply (terminal 1).
2. If a USB device that is connected to the mains is connected, the internal power supply (terminal 1) must not be connected. The power must be supplied from an external device.

11.4.2.2 Connection terminal with protection type "e" (IEC/EN 60079-7)

The X5 and X7 connection terminals have protection type "e".

Flexible cables with a cross section of 0.2 – 2.5 mm² (AWG24 - AWG14) can be used.

The maximum cable length for the connection with the Ex e USB interfaces (X5 and X7) is 2.5 m [8.2 ft].

The insulation of the wire must reach right up to the terminal body.

11.4.2.2.1 Type 1 connection version

- The USB device does not require an external power supply as it uses less than 500 mA.
- No connection to the mains via other interfaces, e.g. WLAN stick.

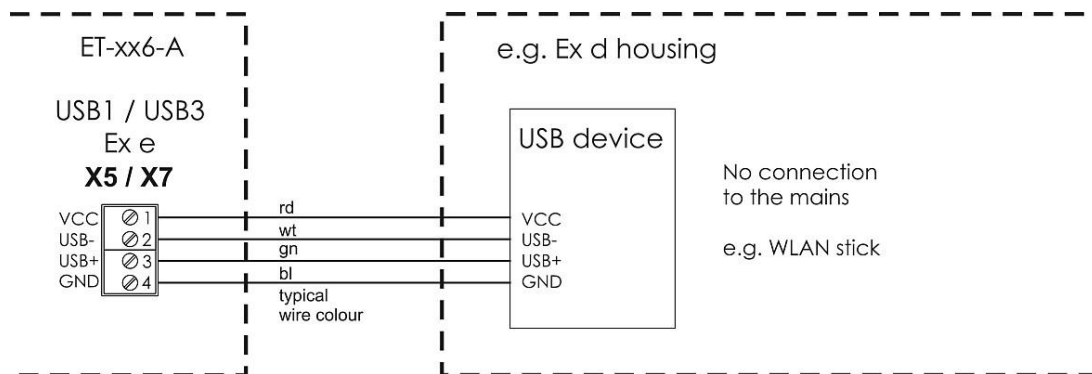

Type 1 connection diagram (e.g. WLAN stick)

11.4.2.2.2 Type 2 connection version

- The USB device does require an external power supply to function because it uses over 500 mA (e.g. hard disks, CD / DVD drives).
- The USB device is connected to the mains via other interfaces (e.g. USB / serial converter).

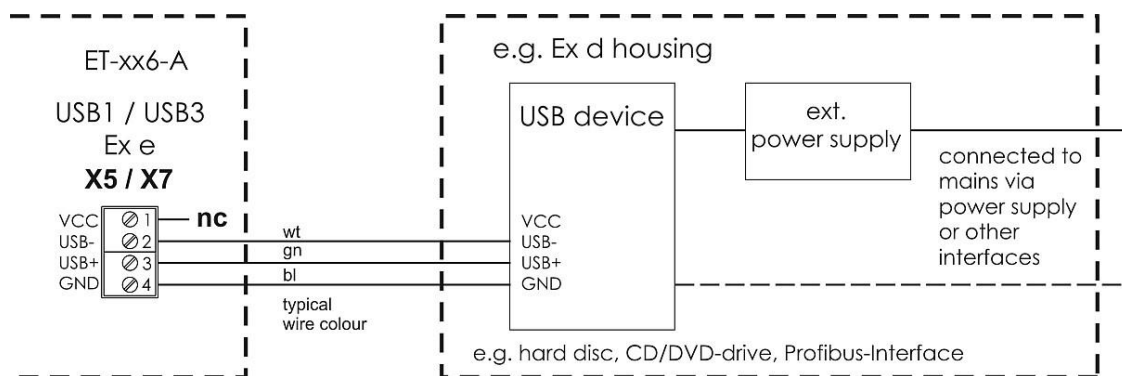

Type 2 connection diagram (e.g. hard disk, CD / DVD with power supply)

11.4.2.2.3 Type 3 connection version

- The USB device does not require an external power supply to function because it uses over 500 mA (e.g. hard disks, CD / DVD drives).
- The USB device is connected to the mains via other interfaces (e.g. USB / serial converter).
- The USB device needs the VCC connection of the HMI device (internal supply – terminal 1) to function.

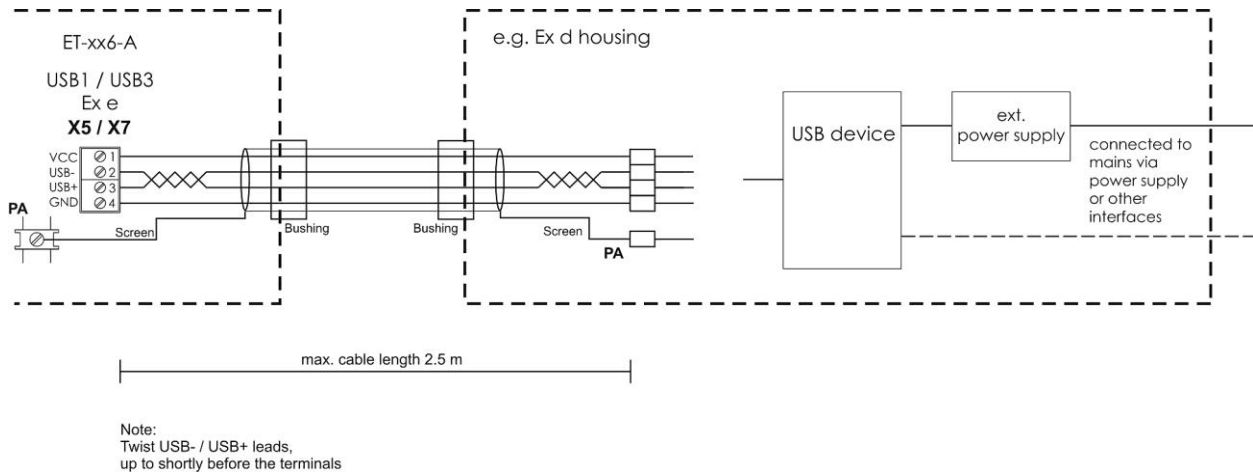

Type 3 connection diagram (any USB device with power supply)

12 Assembly and disassembly

12.1 General information

! NOTICE	Assembly and disassembly are subject to general technical rules. Additional, specific safety regulations apply to electronic and pneumatic installations.
-----------------	---

12.2 Cut-out ET-xx6-A-*

Make a cut-out with the following dimensions:

HMI device	Width	Height	Depth of cut-out	Material thickness
ET-x06-A-*	385.5 ± 0.5 mm [1.26 ± 0.0016 ft]	257.5 ± 0.5 mm [0.84 ± 0.0016 ft]	150 mm [0.49 ft]	up to 8 mm [0.0087 ft]
ET-x16-A-*	359.5 ± 0.5 mm [1.18 ± 0.0016 ft]	257.5 ± 0.5 mm [0.84 ± 0.0016 ft]	150 mm [0.49 ft]	up to 8 mm [0.0087 ft]
ET-x36-A-*	427.5 ± 0.5 mm [1.40 ± 0.0016 ft]	327.5 ± 0.5 mm [1.07 ± 0.0016 ft]	165 mm [0.54 ft]	up to 8 mm [0.0087 ft]
ET-x56-A-*	522.5 ± 0.5 mm [1.71 ± 0.0016 ft]	412.5 ± 0.5 mm [1.35 ± 0.0016 ft]	165 mm [0.54 ft]	up to 8 mm [0.0087 ft]

13 Operation

13.1 General information

	<p>When operating the devices, particular care shall be taken that:</p> <ul style="list-style-type: none"> • the HMI device has been properly installed according to instructions, • the device is undamaged, • the terminal compartment is clean, • all screws are tightened fast, • before switching the HMI device on, its external PE terminal is properly connected to the equipotential bonding system at its place of use, • the cover of the terminal compartment is completely closed.
---	---

13.2 Connections

Terminal	Pin	Definition	Connection	
X1	1	Power supply HMI device +24 VDC	Power supply of the HMI device	
	2	Power supply HMI device +24 VDC		
	3	Power supply HMI device GND		
	4	Power supply HMI device GND		
X2	1	TxD-b	Serial COM1 interface * RS-422/485	
	2	TxD-a		B (+)
	3	RxD-b		A (-)
	4	RxD-a		
	5	TxD-b'		
	6	TxD-a'		
	7	RxD-b'		
	8	RxD-a'		
	9	TxD	Serial COM1 interface * RS-232	
	10	RxD		
	11	RTS/		
	12	CTS/		
	13	GND		
X22	1	TxD-b	Serial COM2 interface * RS-422/485 (optional)	
	2	TxD-a		
	3	RxD-b		
	4	RxD-a		
	5	TxD	Serial COM2 interface * RS-232 (optional)	
	6	RxD		
	7	RTS/		
	8	CTS/		
	9	GND		
X3	1	Line Out right	Audio Ex e	
	2	GND		
	3	Line Out left		
X4		USB interface, connection type A	USB0 I.S.	
X5	1	VCC	USB1 Ex e	
	2	USB -		
	3	USB +		
	4	GND		

X6	1	VCC	USB2 I.S.
	2	USB -	
	3	USB +	
	4	GND	
	5	GND	
X7	1	VCC	USB3 Ex e
	2	USB -	
	3	USB +	
	4	GND	
X8	0	+U_INT1	Reader interface ** I.S.
	1	0V	
	2	+U_EX1	
	3	GND	
	4	+U_RD	
	5	Signal 1	
	6	Signal 2	
	7	Signal 3	
	8	Signal 4	
9	+U_EX1 (out)		
X9	1	VCC	PS2 interface *** I.S. for external keyboard / mouse
	2	KBDAT	
	3	KBCLK	
	4	MSDAT	
	5	MSCLK	
	6	GND	
X10	1	Optical fiber connection type SC	Ethernet optical fiber interface *4
X11	1	TxD (+)	Ethernet copper Connection *4
	2	TxD (-)	
	3	RxD (+)	
	4	RxD (-)	

 NOTICE	<p>* The COM interface may only be wired as a RS-232 or as a RS-422/485 connection ! Simultaneous wiring of the RS-232 and RS-422/485 interface is not allowed !</p> <p>** Either the optional second serial interface (X22) or the reader interface (X8) can be used (see also "Type code") !</p> <p>*** Do NOT connect the optional external keyboard to live equipment !</p> <p>*4 Please note that the Ethernet connection is either for an optical fibre connection (X10) or for a copper connection (X11), depending on the version ordered ! The optical fiber connection requires a multimode optical fiber cable with 62.5 µm core diameter and 125 µm external diameter. Copper wires with cross sections of between 0.2 mm² (AWG24) and 2.5 mm² (AWG14) may be connected to any of the terminals of the HMI devices. Which cable cross sections are chosen should be decided on the basis of relevant regulations, such as DIN VDE 0298. Factors that might require a larger cross section, such as current, increased temperatures, cable bundling, etc. must also be taken into account !</p>
---	---

13.2.1 Dip switch settings S3 and S4

13.2.1.1 Serial interface COM1

Switch	Position	Interface	Function
S3-1	OFF	COM1 RS-422/485	No bus terminator resistor set
	ON		Bus terminator resistor TxD line
S3-2	OFF		No bus terminator resistor set
	ON		Bus terminator resistor RxD line

S4-1	S4-2	S4-3	Interface	Keying
0	0	0	COM1 RS-422	Automatic keying
0	1	0		Keying always on
0	0	1		Keying enabled by SW
0	1	1		Driver in idle mode
1	0	0	COM1 RS-485	Automatic keying
1	1	0		Status not permitted !!!
1	0	1		Keying enabled by SW
1	1	1		Driver in idle mode
S4-4	OFF		Touch	Without function
	ON			

13.2.1.2 Serial interface COM2

Switch	Position	Interface	Function
S3-1	OFF	COM2 RS-422/485	No bus terminator resistor set
	ON		Bus terminator resistor TxD line
S3-2	OFF		No bus terminator resistor set
	ON		Bus terminator resistor RxD line

S4-1	S4-2	S4-3	Interface	Keying
0	0	0	COM2 RS-422	Automatic keying
0	1	0		Keying always on
0	0	1		Keying enabled by SW
0	1	1		Driver in idle mode
1	0	0	COM2 RS-485	Automatic keying
1	1	0		Status not permitted !!!
1	0	1		Keying enabled by SW
1	1	1		Driver in idle mode
S4-4	-		-	Not assigned

13.2.2 View connection compartment

- with COM2, variant FX

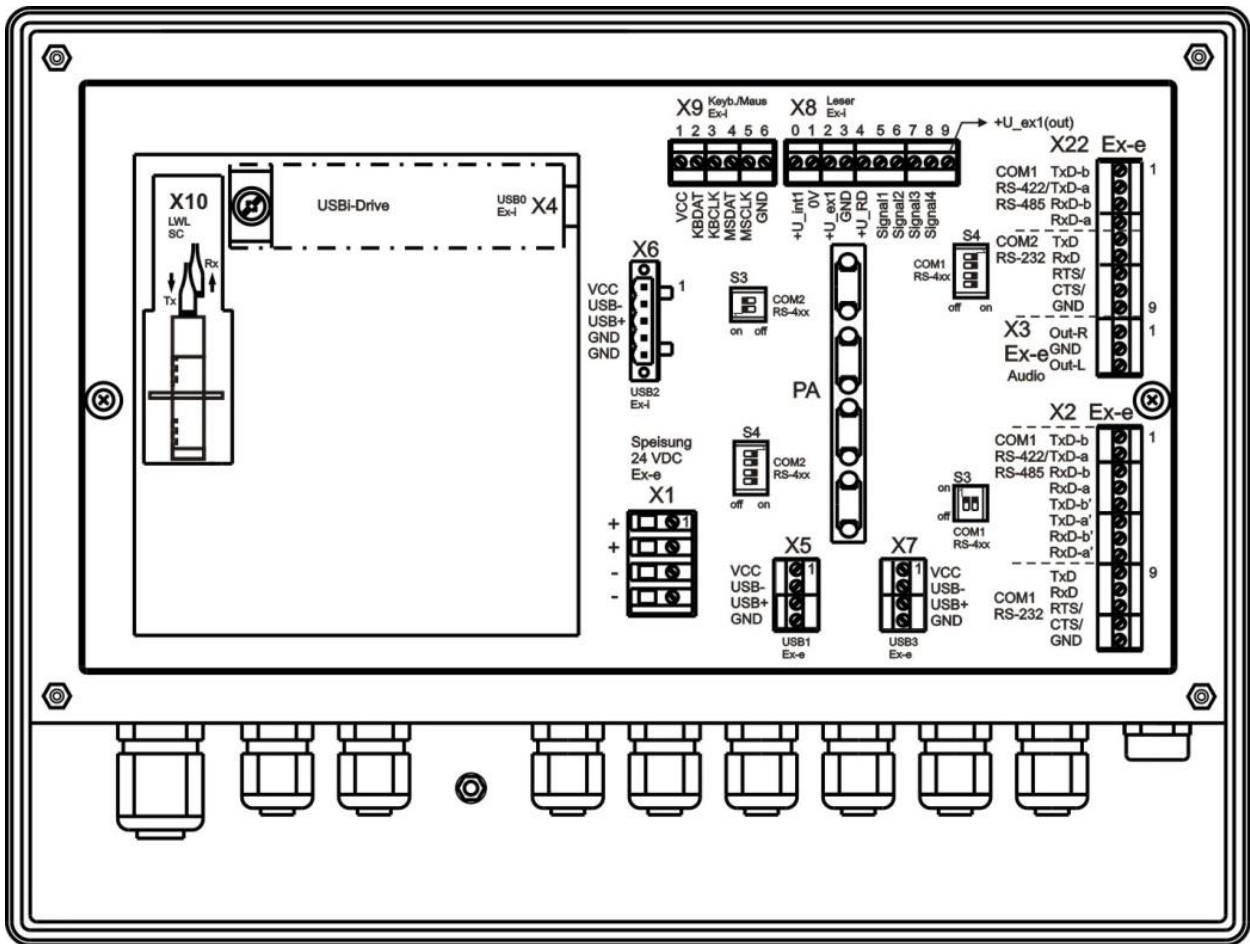

13.2.3 Status LEDs

The status of the respective LEDs at the HMI devices indicates the activity of the corresponding data lines.

These LEDs are located underneath the additional back lid that covers the interface circuit board. This additional back lid needs to be removed in order to see these LEDs.

CAUTION	In hazardous areas the HMI device must not be operated without the housing lid !
	The status LEDs can therefore only be observed at the first start-up or in safe areas.

13.2.3.1 LEDs

Definition	Colour	Name	Description
LD5	green	COM1 TxD	Activity on COM1: sending, LED flashing
LD8	yellow	COM1 RxD	Activity on COM1: receiving, LED flashing
LD7	green	COM2 TxD	Activity on COM2: sending, LED flashing
LD6	yellow	COM2 RxD	Activity on COM2: receiving, LED flashing
LD14	yellow	LINK ACT	Ethernet link established, LED always on Activity on Ethernet link, LED flashing
LD15	green	HD	Access to system disk (Solid State, HDD), LED flashing (only for ET-4x6-A-* devices)

Back view of ET-xx6-A-* device (without COM2 - for clarity's sake):

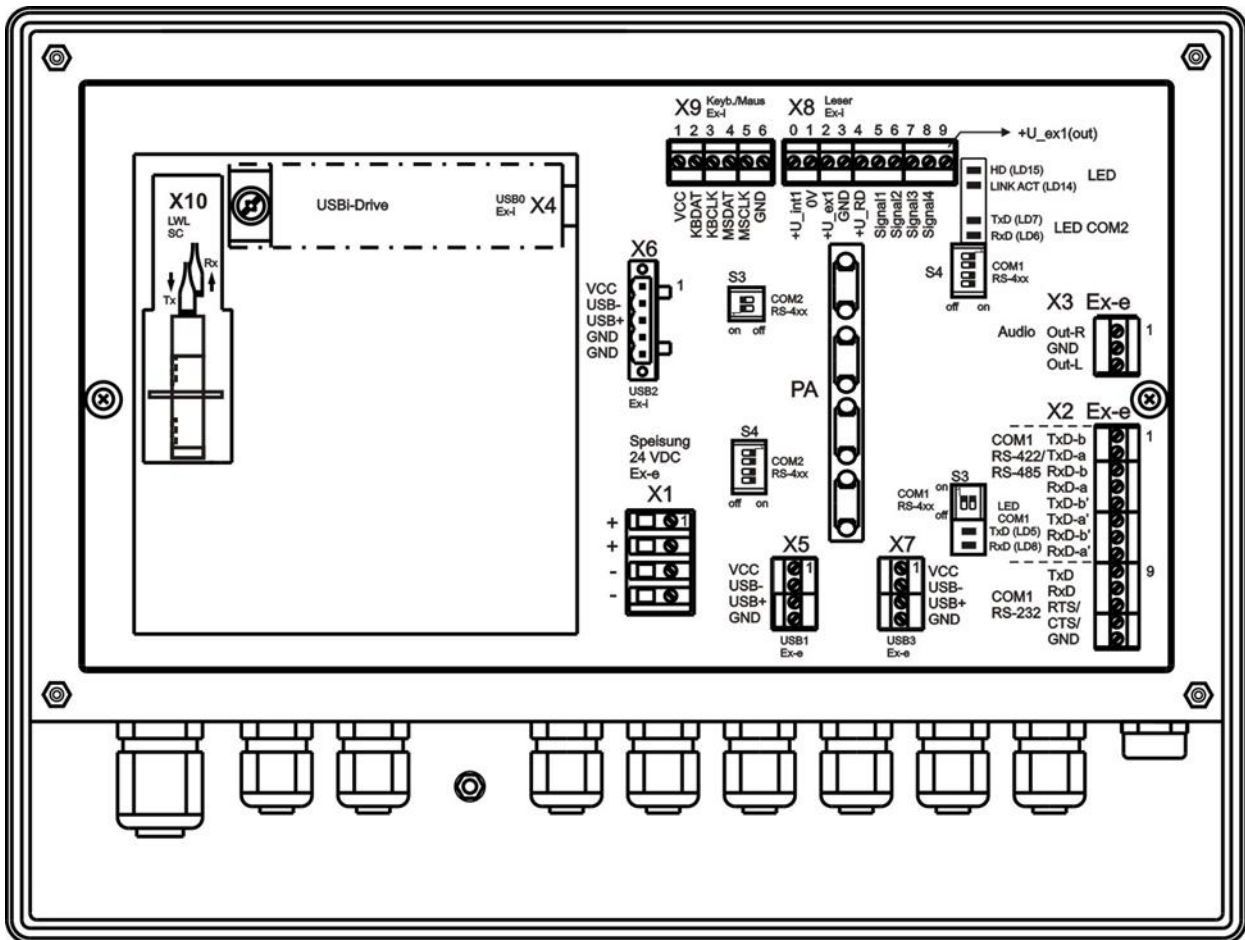

LED section at ET-xx6-A-* device:

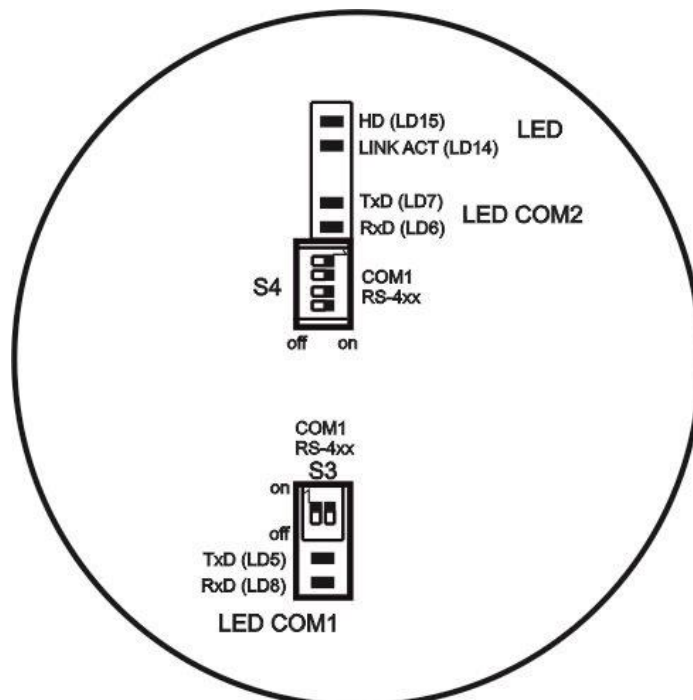

13.3 Connection of Readers

Readers with a serial RS-232 interface can be connected to the HMI devices. For this, the HMI device had to be fitted with a corresponding module for reader devices (see type code) or the ReaderBox must be used.

! ATTENTION	Please note that the Ex-connection values of the reader must match the safety-relevant values of the interface !
--------------------	--

DOCUMENTATION	For the exact wiring diagram of each individual reader type, please refer to the actual reader documentation or to the Hardware Manual.
----------------------	---

HMI devices of the Panel PC and Thin Client series require an additional software (keyboard wedge) to transfer the data from the reader into the required application. This software is **NOT** part of the delivery.

13.3.1 Type RSi1 connection version 1

With the RSi1 connection version, the reader is supplied with power via the HMI device. In version 1, a maximum of 5.36 V and 220 mA are available for the reader (e.g. the SK-200 barcode reader).

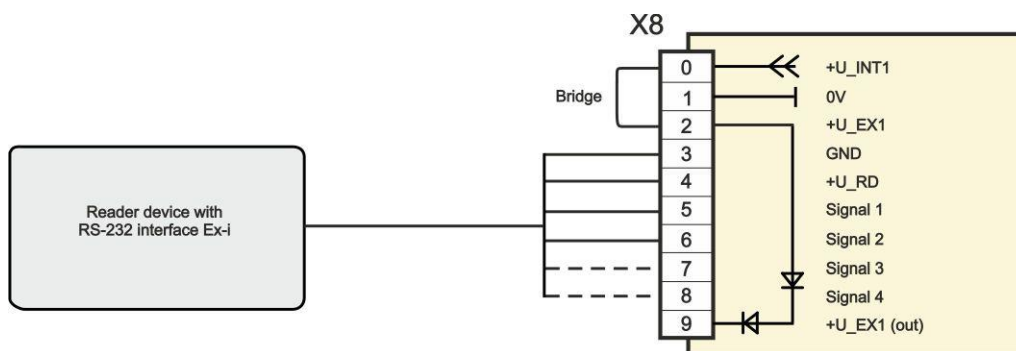

13.3.1.1 Type RSi1 connection version 2

In version 2, a maximum of 10.4 V and 220 mA are available for the reader (e.g. the RFIDI-RDR-2-xxx chipcard reader).

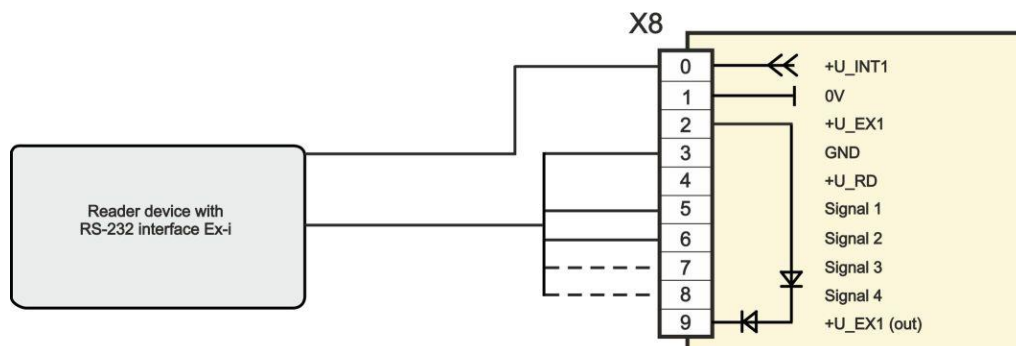

14 Maintenance, service

! NOTICE

Associated equipment is subject to maintenance, service and testing according to guidelines 1999/92/EC, IEC/EN 60079-14, -17, -19 and BetrSichVer (Betriebssicherheitsverordnung - Occupational Safety and Health) !

Because the transmission of the devices remains reliable and stable over long periods of time, regular adjustments are not required.

The following principles apply to repairs *, spare parts purchase* or exchange of parts * (where this can be done by the user !):

- Only original parts provided by the manufacturer must be used.
- Fuses may only be replaced by equivalent fuse types.

DOCUMENTATION

* Please also note [section Troubleshooting](#) !

The ET-xx6-A-* series HMI devices are maintenance-free across their entire lifespan.

System maintenance should focus on the following:

- a. Seal wear
- b. Display damage
- c. All screws are tightened fast
- d. All cables and lines are properly connected and undamaged

! CAUTION

If the device in its factory state is damaged or altered in any way, decommission it immediately and contact the manufacturer !

14.1 Damaged sealing

! NOTICE

If the surrounding seal of the device is damaged, the manufacturer will tick the "No hazloc approved panel mount" option on the device.

The device is only approved for installation inside an Ex e or Ex tb enclosure if no "No hazloc approved panel mount" option is indicated on the device. If the "No hazloc approved panel mount" option is indicated on the device, certification according to NEC / CEC is no longer possible or becomes void !

14.2 Servicing

In accordance with IEC/EN 60079-19 and IEC/EN 60079-17, operators of electric plants in hazardous areas are obliged to have them serviced by qualified electricians.

14.3 Saving data with ET-3x6-A-*

All online data is stored on the internal flash card and are therefore also available after the device has been switched off for a long time.

According to the current state-of-the-art the flash cards retain stored data for about 10 years.

14.4 Time function

Does not apply to ET-5x6-A-*:

When the ET-3x6-A-* and ET-4x6-A-* HMI devices are switched off, their clock function is maintained by a battery and a capacitor. As long as the battery is intact, the clock function is maintained. Once the battery fails, the capacitor takes over and maintains the clock function for about four days. If the HMI device is switched on after a longer interval than that, the time and date have to be re-set manually or via a connected system.

15 Troubleshooting

 NOTICE	Devices operated in hazardous areas must not be modified. Repairs may only be carried out by qualified, authorized staff specially trained for this purpose.
	Repairs may only be carried out by specially trained staff who are familiar with all basic conditions of the applicable user regulations and – if requested – have been authorized by the manufacturer.

16 Disposal

Disposal of old electric and electronic devices, packaging and used parts is subject to regulations valid in whichever country the device has been installed.

For countries under the jurisdiction of the EU the corresponding WEEE directive applies.

The HMI devices are classified according to the table below:

	old	new
Directive	WEEE I Directive 2002/96/EC	WEEE II Directive 2012/19/EU
Valid	until 14.08.2018	from 15.08.2018
Category	9 Monitoring and control devices	SG2 Screens, monitors, and equipment containing screens >100 cm ²

We shall take back our devices according to our General Terms and Conditions.

16.1 RoHS directive 2011/65/EC

The revised version of the RoHS (restriction of hazardous substances) 2002/95/EC directive, directive 2011/65/EC, extends its area of application to all electric and electronic products.

The HMI devices are conform with the requirements from RoHS directive 2011/65/EU, dated 03.01.2013.

16.1.1 China RoHS labelling

According to new Chinese legislation in force since 01.03.2007, all devices containing hazardous substances must be labeled accordingly.

The part of all toxic or hazardous substance contained in the homogeneous materials of the HMI devices is below the limit requirements in SJ/T11363-2006.

17 General Information

17.1 Touch driver

! NOTICE

The UPDD touch driver is copyrighted licensed software supplied strictly for use with original R. STAHL HMI Systems GmbH touch systems and under no circumstances should this driver be downloaded or used on any other equipment !

17.2 Keyboard features

! NOTICE

The information according the keyboard features applies **ONLY** to the 300 and 400 SERIES of HMI devices, and **NOT** to the 500 SERIES.

Pressing two keys at once (e.g. F1 + F7) is not supported by the HMI devices !

In such a case, the system considers the key that was pressed first as "active" and implements the associated functions and / or key bit functions !

The key pressed second is ignored.

The key kombination of Ctrl + Alt + Del can **NOT** be realized via the virtual keyboard !

For this you must use an external connected keyboard !

If you like to have a simulation from the key kombination of Ctrl + Alt + Del via the F-keys of the HMI device, it must be stated when ordering, as it can only be done by the manufacturer **before delivery**.

Pressing the keys F1, F2 and F8 at the same time, if the F-key simulation is activated, it has the same effect as pressing Ctrl + Alt + Del !

ET-306-A-* only:

Pressing the S1 – S10 softkeys on the ET-306-A-* has the same effect as pressing the numerical keys (num lock) 0 – 9.

At the image Movicon CE only the S1 – S10 softkeys are allocated as the combination of Shift + F1 – Shift + F10 keys function.

ET-406-A-* only:

Pressing the S1 – S10 softkeys on the ET-406-A-* has the same effect as pressing the combination of Shift + F1 – Shift + F10 keys function.

17.3 ET-4x6-A-* (Panel PC)

17.3.1 Up to Windows 7 operating systems

17.3.1.1 Licensing issues

The Panel PC devices SERIES 400 which are pre-installed with a Windows operating system are equipped with a license sticker.

The license sticker is affixed on the back of the HMI device, next to the type plate.

Please note that according to the license issued for Windows the application of this system as an Office PC is not permitted.

 DOCUMENTATION	<p>Please also note the information on the licensing stipulations for Windows operating systems contained in the "TechNote Windows Operating Systems" file located on the CD / DVD / USB stick, which is part of the delivery.</p>
---	--

17.3.1.2 Note on Windows Embedded operating systems

When using the Windows Embedded operating systems (XP or Windows Standard 2009 / 7) on the Panel PC devices SERIES 400, the C:\ system drive can be protected from unauthorised writing (EWF).

 NOTICE	<p>This is NOT the case with other Windows operating systems !</p>
--	---

 ATTENTION	<p>R. STAHL HMI Systems GmbH recommends you leave the write protection filter on at all times !</p>
---	---

 DOCUMENTATION	<p>For further information regarding this Write Protection (EWF), please refer to the OpenHMI_help_en.chm help file in the "STAHL" folder on the device or on the CD / DVD / USB stick that is included in the delivery.</p>
---	--

17.3.2 Windows® 10 IoT Enterprise 2016 LTSB operating system

The operating system is based on Windows 10 for PC platforms with 64 bit x86 processors. For the LTSB (Long-Time-Service-Branch) versions, Microsoft guarantees 10 years of security updates and new builds with feature updates only every 2-3 years, with these being optional. The LTSB versions are ideal for industrial applications and feature additional security components such as write filters (UWF) and HORM (start of a system snapshot from the RAM plus write protection).

From 2016 LTSB onwards, Microsoft has tied its licensing model to the processor performance:

ENTRY	for AMD® GX and ATOM™
VALUE	for Intel® Core i5™
HIGH	for Intel® Core i7™

The Panel PC SERIES 400 HMI devices with Windows 10 IoT Enterprise 2016 LTSB operating systems have the license provided as part of the image, with the corresponding label affixed to the back of the device. When delivered, the devices have already been registered and activated.

The EOL (End of Life) date for Windows 10 IoT Enterprise 2016 LTSB for support and updates has been set by Microsoft to 31.07.2026.

17.3.2.1 Recovery

 NOTICE	<p>If a Panel PC is reset to the factory state (recovered) it will remain registered but will have to be reactivated ! This requires an active internet connection to a Microsoft server !</p>
---	--

17.3.2.2 Company-specific Windows installations

 NOTICE	<p>The Windows 10 IoT license key is tied to STAHL images ! The installation of own Windows 10 IoT operating systems requires a separate license key !</p> <p>All necessary drivers are provided by R.STAHL HMI Systems GmbH. Please contact our Support department.</p>
---	--

17.3.3 Initial start-up

When the device is started for the first time, the Windows installation assistant starts where users have to select certain settings.
Please follow the instructions of the installation assistant.

17.3.4 Recovery Stick

 NOTICE	<p>To restore your Panel PC device to its original state you will need a Recovery Stick, which is available as an optional extra. This recovery stick (USB-drive, also available intrinsically safe) contains the factory image, with which the system can be restored to delivery status within a very short time.</p> <p>Please note that you can restore the HMI devices to their original state only with the aid of the Recovery Stick</p> <p>As an option, the recovery stick can also contain a backup software, with which you can back up your own device configuration.</p>
---	---

17.3.5 Back-up

 NOTICE	<p>Please note that it is the sole responsibility of the operator to generate a back-up of the HMI devices and their overall function.</p> <p>We strongly recommend such a back-up to be stored on an external storage medium or on the company network.</p>
---	--

17.3.6 Switching off / closing down

**NOTICE**

The Microsoft Windows operating system stores key data in the main memory, regardless of the application, and has to store this data on the hard disk before the HMI device is switched off.

**ATTENTION**

It is therefore important for the safe and correct operation that the HMI device is closed down properly (see illustration below) and **NOT** simply switched off. Otherwise the existing image of the device may be damaged, rendering the HMI device non-functioning.

After the data has been stored, Windows informs the user that the HMI device can now be switched off.

**ATTENTION**

Only switch off the HMI device once you have received this message !

17.3.7 Data loss

**NOTICE**

In the case of applications that require constant writing into memory, R. STAHL HMI systems recommends you use external storage media (USB sticks, network servers) for these write processes.

**ATTENTION**

Try and avoid cyclical writes (log files, databases, etc.) to the SSD ! The endurance of an SSD depends on the number of write cycles (TBW / terabytes written). Writing to the SSD with a simultaneous drop in voltage is most likely going to result in data loss !

17.4 Defective pixels

As a result of the manufacturing process (production tolerances and errors) for the displays they may be delivered with defective pixels. Provided they are within the range of the specification below these potential defective pixels are not a display or HMI error or defect.

17.4.1 Terminology

Defective pixels Pixels or sub-pixels that do not perform as expected and are either always on or always off

Pixel Image point on the display consisting of 3 sub-pixels in the basic colours red, green and blue



Dot Sub-pixel in the basic colour red, green or blue



Bright Sub-pixel (dot) to which light is passing through, creating a bright dot that is on

Dark Sub-pixel (dot) to which no light is passing through, creating a dark dot that is off

adjacent dots dots positioned next to one another, horizontally, vertically or diagonally, bright or dark (e.g. the following pattern and sub-pixels)

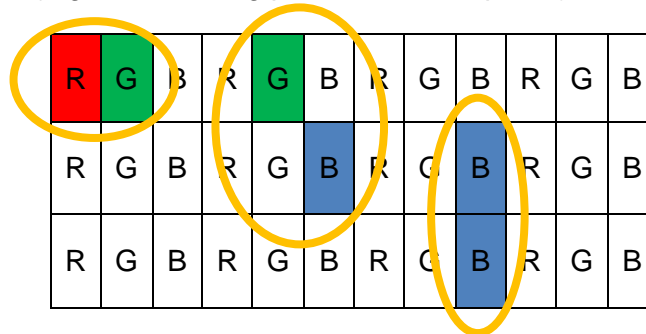

Distance between Dots Definition of distance between two defective dots horizontal, vertical or diagonal, bright or dark (e.g. the following pattern and sub-pixels)

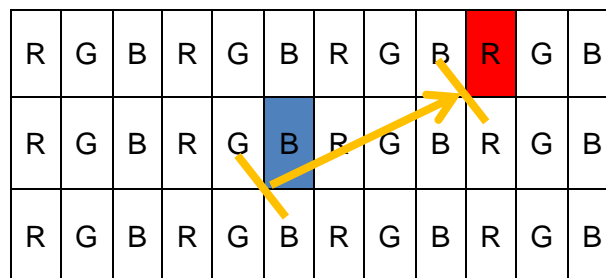

17.4.2 Display specification

Type of defect / description	max. number of permitted defects		
	10.4" display	15" display	19" display
Linear defect (horizontal, vertical)	not permitted		
Defective pixels			
bright dots	≤ 3	≤ 2	≤ 2
dark dots	≤ 4	≤ 3	≤ 5
total number of dots	≤ 5	≤ 5	≤ 5
adjacent dots			
2 bright dots	not permitted	≤ 1 pair	≤ 1 pair
more than 3 bright dots	not permitted		
2 dark dots	≤ 1 pair	≤ 1 pair	≤ 2 pairs
more than 3 dark dots	not permitted		
Distance between the dots			
between 2 bright dots	not permitted	≥ 15 mm	≥ 15 mm
between 2 dark dots	≤ 5 mm	≥ 15 mm	≥ 15 mm
between 1 bright and 1 dark dot	≤ 15 mm	≥ 15 mm	≥ 15 mm

18 Declaration of EC conformity

EG/EU-Konformitätserklärung
EC/EU Declaration of Conformity
Déclaration de Conformité CE/UE



R. STAHL HMI Systems GmbH • Adolf-Grimme-Allee 8 • 50829 Köln, Germany
 erklärt in alleiniger Verantwortung, declares in its sole responsibility, déclare sous sa seule responsabilité,

dass das Produkt: Bedien- und Beobachtungsgeräte
 that the product: Operating and Monitoring Devices
 que le produit: Consoles de commande et de visualisation

Typ(en), type(s), type(s): **EXICOM**
ET-306-A-*.;** **ET-406-A-*.**;** **ET-506-A-*.**;**
ET-316-A-*.;** **ET-416-A-*.**;** **ET-516-A-*.**;**
ET-336-A-*.;** **ET-436-A-*.**;** **ET-536-A-*.**;**
ET-356-A-*.;** **ET-456-A-*.**;** **ET-556-A-*.**;**
 * = Fx or Tx
 ** = HDn and/or SR and/or additional information (not ex-relevant)

mit den Anforderungen der folgenden Richtlinien und Normen übereinstimmt.
 is in conformity with the requirements of the following directives and standards.
 est conforme aux exigences des directives et des normes suivantes.

Richtlinie(n) / Directive(s) / Directive(s)		Norm(en) / Standard(s) / Norme(s)	
		Das Produkt entspricht Anforderungen aus: Product corresponds to requirements from: Produit correspond aux exigences:	
2014/34/EU	ATEX-Richtlinie	IEC 60079-0:2011	EN 60079-0:2012/A11:2013
2014/34/EU	ATEX Directive	IEC 60079-1:2007	EN 60079-1:2014
2014/34/UE	Directive ATEX	IEC 60079-7:2006	EN 60079-7:2007
		IEC 60079-11:2011	EN 60079-7:2015 (Ab/From/De 01.08.2018)
		IEC 60079-18:2009	EN 60079-11:2012
		IEC 60079-28:2006	EN 60079-18:2015
		IEC 60079-31:2008	EN 60079-28:2015
			EN 60079-31:2014

Kennzeichnung, marking, marquage:

TypeTX:
 II 2 (2) G Ex db eb ia ib mb [ia ib] IIC T4 Gb
 II 2 (2) D Ex ia tb [ia ib] IIIC T80°C Db IP66
 Type FX:
 II 2 (2) G Ex db eb ia ib mb [ia ib op is] IIC T4 Gb
 II 2 (2) D Ex ia tb [ia ib op is] IIIC T80°C Db IP66

CE 0158

EG/EU-Baumusterprüfbescheinigung: TÜV 11 ATEX 7041 X
 EC/EU Type Examination Certificate: TÜV Rheinland Industrie Service GmbH (NB 0035)
 Attestation d'examen CE/UE de type: Am grauen Stein, 51105 Köln (Cologne), Germany

2014/30/EU	EMV-Richtlinie	EN 61000-6-2: 2006
2014/30/EU	EMC Directive	EN 61000-6-4: 2007 + A1:2011
2014/30/UE	Directive CEM	EN 61326-1:2013
Produktnormen nach RoHS-Richtlinie (2011/65/EU): Product standards according to RoHS Directive: Normes des produit pour la Directive RoHS:		EN 50581:2012

Köln, 2018-06-15

i.V. 
J. Düren
 Technical Director

i.V. 
A. Jung
 Ex Representative

Ort und Datum
 Place and date
 Lieu et date

20155070014 Konformitätserklärung ET-xx6-A.docx

Template_EGEU_Konf_20150720.docx, Page 1 / 1

18.1 RCM

Supplier's declaration of conformity



As required by the following Notices:

- > *Radiocommunications (Compliance Labelling - Devices) Notice 2014* made under section 182 of the *Radiocommunications Act 1992*;
- > *Radiocommunications Labelling (Electromagnetic Compatibility) Notice 2017* made under section 182 of the *Radiocommunications Act 1992*
- > *Radiocommunications (Compliance Labelling – Electromagnetic Radiation) Notice 2014* made under section 182 of the *Radiocommunications Act 1992* and
- > *Telecommunications (Labelling Notice for Customer Equipment and Customer Cabling) Instrument 2015* made under section 407 of the *Telecommunications Act 1997*.

Instructions for completion

- > *Do not return this form to the ACMA.* This completed form must be retained by the supplier as part of the documentation required for the compliance records and must be made available for inspection by the ACMA when requested.

Supplier's details (manufacturer, importer or authorised agent)

Company Name (OR INDIVIDUAL)

R. STAHL Australia Pty Ltd
TRADING AS R. STAHL HMI Systems GmbH

ACN/ARBN

ABN 81 150955838

OR

New Zealand IRDN

--

Street Address (AUSTRALIAN or NEW ZEALAND)

848 Old Princes Highway
Sutherland, NSW
POSTCODE 2232
Phone: +61 2 4254 4777

Product details and date of manufacture

Product description – brand name, type, current model, lot, batch or serial number (if available), software/firmware version (if applicable)

<p>Operating and Monitoring Devices</p> <p>EXICOM ET-306-A-***; ET-406-A-***; ET-506-A-***; ET-316-A-***; ET-416-A-***; ET-516-A-***; ET-336-A-***; ET-436-A-***; ET-536-A-***; ET-356-A-***; ET-456-A-***; ET-556-A-***; * = Fx or Tx, ** = HDn and/or SR and/or additional information</p>
<p>Operating and Monitoring Devices</p> <p>EXICOM MT-306-A-***; MT-406-A-***; MT-506-A-***; MT-316-A-***; MT-416-A-***; MT-516-A-***; MT-336-A-***; MT-436-A-***; MT-536-A-***; MT-356-A-***; MT-456-A-***; MT-556-A-***; * = Fx or Tx, ** = HDn and/or SR and/or additional information</p>
<p>Keyboard</p> <p>KBD(i)-PS2-***; *** = In the complete type denomination, the asterisks are replaced by letters or numbers to identify different variations.</p>
<p>Keyboard with Joystick / Trackball</p> <p>KBD(i)-TB-PS2-***; KBD(i)-JS-PS2-***; **=any character without relevance for explosion protection</p>

Keyboard with Joystick
KBDI-JS2-PS2-xx; xx = The asterisks are replaced by letters to mark different country-specific keyboard-designs.

Compliance – applicable standards and other supporting documents

Evidence of compliance with applicable standards may be demonstrated by test reports, endorsed/accredited test reports, certification/competent body statements.

Having had regard to these documents, I am satisfied the above mentioned product complies with the requirements of the relevant ACMA Standards made under the *Radiocommunications Act 1992* and the *Telecommunications Act 1997*.

List the details of the documents the above statement was made, including the standard title, number and, if applicable, number of the test report/endorsed test report or certification/competent body statement

EN 61000-6-4:2011-09; EN 61000-6-4:2007 + A1:2011; EN 55022:1994 + A1:1995 + A2:19997

Declaration

I hereby declare that:

1. I am authorised to make this declaration on behalf of the Company mentioned above,
2. the contents of this form are true and correct, and
3. the product mentioned above complies with the applicable above mentioned standards and all products supplied under this declaration will be identical to the product identified above.

Note: Under section 137.1 of the *Criminal Code Act 1995*, it is an offence to knowingly provide false or misleading information to a Commonwealth entity.
Penalty: 12 months imprisonment

 SIGNATURE OF SUPPLIER OR AGENT John Zagame PRINT NAME	Managing Director POSITION IN ORGANISATION 2018-10-15 DATE
--	---

The *Privacy Act 1988* (Cth) (the Privacy Act) imposes obligations on the ACMA in relation to the collection, security, quality, access, use and disclosure of personal information. These obligations are detailed in the Australian Privacy Principles.

The ACMA may only collect personal information if it is reasonably necessary for, or directly related to, one or more of the ACMA's functions or activities.

The purpose of collecting the personal information in this form is to ensure the supplier is identified in the 'Declaration of conformity'. If this Declaration of Conformity is not completed and the requested information is not provided, a compliance label cannot be applied.

Further information on the Privacy Act and the ACMA's Privacy Policy is available at www.acma.gov.au/privacypolicy. The Privacy Policy contains details about how you may access personal information about you that is held by the ACMA, and seek the correction of such information. It also explains how you may complain about a breach of the Privacy Act and how we will deal with such a complaint.

Should you have any questions in this regard, please contact the ACMA's privacy contact officer on telephone on 1800 226 667 or by email at privacy@acma.gov.au.

19 Release notes

The chapter entitled "Release Notes" contains all the changes made in every version of the Operating Instructions.

Version 03.02.16

- Removal of previous release notes
- Changing text "Notice" in section "Usage of USB Memory-Sticks", removal of "non-"
- Dip switch S4-4 "changing function"
- Addition of section "Touch driver"
- Changing section "General informationen", Notice moved into section "keyboard features"
- Changing "text at notice" "COM interface connection" in section "Connections"
- Renew / changing EAC certificate number
- Formal changes

R. STAHL HMI Systems GmbH
Adolf-Grimme-Allee 8
D 50829 Köln

T:	(switchboard)	+49 221 76 806	- 1000
	(Hotline)	+49 221 76 806	- 5000
F:		+49 221 76 806	- 4100
E:	(switchboard)	office@stahl-hmi.de	
	(hotline)	support@stahl-hmi.de	

r-stahl.com
stahl-hmi.de



THE STRONGEST LINK.