



Operating Instructions



ORCA Device Platform
ORCA01E* / ORCA01M*
Panel-mount devices / Operator Stations
Panel PC / Thin Clients
Direct Monitor



THE STRONGEST LINK.

Doc. no.: 2022 41 7000 0

HW-Rev. E/M5xA:	01.01.03
HW-Rev. E/M79A:	01.01.03

Operating Instructions Version:	01.00.08
Issue:	05.08.2024

Article number:	309310
-----------------	--------

Table of contents

	Description	Page
	Table of contents	2
1	General information	8
1.1	Manufacturer	8
1.2	Legal notice	8
1.2.1	Trademark	8
1.2.2	Disclaimer	8
1.3	About these operating instructions	9
1.3.1	Target group	9
1.3.2	How to use this manual	9
1.3.3	Application	9
1.4	Further documents	9
1.5	Conformity with standards and regulations	10
1.5.1	Certificates	10
1.5.2	Approvals	10
	Europe (CE / ATEX)	10
	Global (IECEX)	10
	USA (NEC)	10
	Canada (CE-Code)	10
	China (CCC / CNEEx)	10
	India (PESO)	10
	India (BIS)	10
	Marine / ship approval (DNV)	11
1.5.3	Summary of applied standards	12
1.5.3.1	ATEX / IECEX	12
1.5.3.2	EMC Directive 2014/30/EU	12
1.5.3.3	Radio equipment directive 2014/53/EU	12
1.5.3.4	Low voltage directive 2014/35/EU	12
1.5.3.5	RoHS Directive 2011/65/EU	12
2	Explanation of symbols	13
2.1	Symbols used in these Operating Instructions	13
2.2	Warning notes	13
2.3	Symbols on the device	14
3	Safety	15
3.1	Intended use	15
3.2	Predictable improper use	16
3.3	Personnel qualification	16
3.4	Special conditions of use	17
3.5	Residual risks	17
3.5.1	Explosion hazard	17
3.5.2	Risk of injury	19
3.5.3	Device damage	19
3.6	Industrial Security	20
4	Function and device design	21
4.1	Features and versions	21

4.1.1	Options	21
4.1.2	Panel-mount device	21
4.1.2.1	D-Box	21
4.1.2.2	E-Box	22
4.1.2.3	Combination options of D-Box and E-Box	22
4.1.3	Operator Station	22
4.1.3.1	Card reader for access control	23
4.1.4	Accessories	23
4.1.5	Scope of delivery	24
4.1.5.1	Panel-mount device	24
4.1.5.2	Operator Station	24
4.2	Device design	25
4.2.1	Panel-mount device	25
4.3	Type code	26
4.3.1	Family code	26
4.3.2	Type key code field system	27
4.4	Available configuration versions	32
4.5	Dimensions	33
4.5.1	Panel-mount devices	33
4.5.1.1	Front	33
4.5.1.2	Side	33
4.5.1.3	Cutout	34
4.5.2	ORCA-OFR Operator Station	35
4.5.3	ORCA-OFR Operator Station with keyboard	35
4.5.4	ORCA-FR Operator Station with sun roof	36
4.5.5	ORCA-FR Operator Station with keyboard and sun roof	36
4.6	Connection box	37
4.6.1	E-Box Standard	37
4.6.2	E-Box PRO	38
4.7	Operating elements	39
4.7.1	Sensors	40
4.8	LED status display	40
4.9	Markings on the device	41
4.9.1	Position	41
4.9.1.1	Field system label	41
4.9.1.2	Label on E-Boxes	41
4.9.1.3	Label on display boxes	42
4.9.1.4	Warning label	42
4.9.1.5	Safety label	43
4.9.2	Design of label / type plate	43
4.9.2.1	Field system label / type plate	43
4.9.2.2	E-Box Label	44
4.9.2.3	D-Box Label	44
4.9.2.4	Key to E-Box and D-Box labels	45
4.10	Ex marking	46
4.10.1	ATEX / IECEx	46
4.10.2	USA / Canada UL	46

4.10.3	PESO	47
5	Operating systems and drivers	48
5.1	Windows 10 IoT Enterprise LTSC 2019 / 2021 operating system	48
5.1.1	Recovery	48
5.1.2	Proprietary Windows installations and drivers	48
5.2	Data back-up	48
5.2.1	Recovery Stick	48
5.2.2	Back-up	49
5.2.3	Switching off / closing down	49
5.2.4	Loss of data	49
5.3	License sticker	50
5.4	UPDD touch driver	50
6	Transport and storage	51
7	Unpacking	51
8	Mounting and installation	52
8.1	Note on mounting and installation	52
8.1.1	Note on mounting and installation according to NEC / CE-Code / UL	52
8.2	Requirements for site of installation	53
8.3	Mounting types	54
8.4	Front installation	54
8.4.1	Panel-mount – installation	54
8.5	Mounting instruction card holder	57
8.5.1	Recommended mounting position	57
8.5.1.1	For ORCA01* operating device 22"	57
8.5.1.2	For UB03-*RFID	58
8.6	Installation	59
8.6.1	General information on electric connection	59
8.6.2	Connecting device to power supply	60
8.6.3	Grounding the device	60
8.6.4	Connecting data cable	60
8.6.5	Mounting the cover of the connection box	60
8.6.6	Connecting associated equipment	61
8.6.7	Cable glands	61
8.6.8	Electric connections of interfaces X1, X2, X3, X4, X5, X6, X7, X9, X10, X11, X12 and X13	62
8.7	Using USB interfaces	63
9	Initial start-up	64
10	(Re-) Commissioning	64
11	Operation	65
11.1	Operating the touch display	65
11.2	Switching the device on and off	66
11.2.1	Without optional on/off button	66
11.2.2	With optional on/off button	66
11.3	Teaming function	66
12	Maintenance, overhaul and repair	67
12.1	Changing the battery	67

12.2	Servicing	67
12.3	Maintenance	68
12.4	Repair	68
12.4.1	Mounting / dismantling the modules	68
13	Returning the device	70
14	Cleaning	70
15	Disposal	70
16	Accessories	70
17	Appendix A	71
17.1	Technical data E/M5xA	71
17.1.1	General	71
17.1.2	Electrical data	71
17.1.2.1	Electrical data - device protection	73
17.1.3	Display	74
17.1.4	Ambient conditions	74
17.1.5	Mechanical data	75
17.2	Technical data E/M79A	76
17.2.1	General	76
17.2.2	Electrical data	76
17.2.2.1	Electrical data - device protection	76
17.2.3	Display	77
17.2.4	Ambient conditions	78
17.2.5	Mechanical data	78
17.3	Cable glands	79
17.3.1	E-Box Standard	79
17.3.2	E-Box PRO	80
17.5	Overview Hardware Revision ORCA01	81
18	Appendix B	82
18.1	Connection values	82
18.2	Intrinsically safe interfaces	82
18.2.1	X9 PB – on/off button (Ex ia)	82
18.2.2	X5 / X6 – USB 4/5 (Ex ia)	82
18.2.3	X7 / X8 – USB 6 (Ex ib)	82
18.3	Optical interfaces	83
18.3.1	X15 / X16 – FO 1 / FO 2 type FX	83
18.3.2	X15 / X16 – FO 1 / FO 2 type SX	83
18.3.3	X15 / X16 – FO 1 / FO 2 type LX	83
18.4	Non intrinsically safe interfaces (Ex e)	83
18.4.1	X1 – Power supply	83
18.4.2	X2 / X10 – copper1 / copper2	83
18.4.3	X3 / X11 / X12 / X13 – USB	83
18.4.4	X4 – RSxxx	83
19	Appendix C	84
19.1	Connection overview terminal assignment	84
19.1.1	E-Box Standard	84
19.1.1.1	Ex e terminals	84
19.1.1.2	Ex i terminals	85

19.1.2	E-Box PRO	86
19.1.2.1	Ex e terminals	86
19.1.2.2	Ex i terminals	89
19.1.3	Direct Monitor	90
19.1.3.1	Ex e terminals	90
19.1.3.2	Ex i terminals	90
20	Appendix D	91
20.1	Variation of operating temperature range	91
21	Appendix E	93
21.1	Disposal / restricted substances	93
21.1.1	Declaration of substances and restricted substances	93
21.1.1.1	Declarable substance groups	93
21.1.1.2	RoHS directive 2011/65/EC	93
21.1.1.3	IMO Resolution MEPC.269(68)	93
22	Appendix F	94
22.1	Material resistance	94
22.1.1	Material	94
22.1.1.2	Powder coating	95
22.1.1.3	Front plate seal	95
22.2	Coating compatibility	104
23	Appendix G	105
23.1	Defective pixels	105
23.1.1	Terminology	105
23.1.2	Display specification	106
23.2	Optical specification front glass	107
23.2.1	Test criteria	107
23.3	Optical acceptance of surfaces	109
23.3.1	Optical acceptance glass	109
23.3.2	Optical acceptance printing	110
23.3.3	Optical acceptance, other surfaces	110
24	Appendix H	112
24.1	Control Drawing	112
24.2	Installation Instructions Requirements China	117
24.2.1	ORCA01E*	117
24.2.2	ORCA01M*	119
25	Appendix I	121
25.1	Declarations of conformity	121
25.1.1	EU	121
25.1.1.1	ORCA01E*	121
25.1.1.2	ORCA01M*	122
25.1.2	USA UL	123
25.1.3	Canada UL	125
25.1.4	CCC	127
25.1.4.1	ORCA01E*	127
25.1.4.2	ORCA01M*	138
25.2	Declaration of conformity for Equipment Compilation	150
25.3	Evaluation of transponder media	151

25.3.1	RFID chip cards	151
25.3.2	RFID tag	153
25.4	Conformity assessment card holder	154
26	Appendix J	155
26.1	Release notes	155

1 General information

1.1 Manufacturer

R. STAHL HMI Systems GmbH
Adolf-Grimme-Allee 8
50829 Köln
Germany

Sales Support

Tel.: +49 221 768 06 – 1200
E-mail: sales.dehm@r-stahl.com

Technical Support

Tel.: +49 221 768 06 – 5000
E-mail: support.dehm@r-stahl.com

General

Fax: +49 221 768 06 – 4200
Internet: r-stahl.com

1.2 Legal notice

1.2.1 Trademark

The terms and names used in this document are registered trademarks and / or products of the companies in question.

1.2.2 Disclaimer

- All rights reserved.
- This document may not be reproduced in whole or in part except with the written consent of the publisher.
- This document may be subject to change without notice.

Any warranty claims are limited to the right to demand amendments. Liability for any damage that might result from the contents of these instructions or all other documentation is limited to clear cases of premeditation.

We reserve the right to amend our products and their specifications at any time, provided it is in the interest of technical progress. The information in the current manual (online or on CD / DVD / USB-stick) or in the operating instructions included in the delivery applies.

1.5 Conformity with standards and regulations

1.5.1 Certificates

	Certificates: r-stahl.com
	The devices have IECEx approval. See IECEx homepage: https://www.iecex-certs.com/#/home to view the certificate

1.5.2 Approvals

The following approvals are valid for all devices:

Synonym	Scope of validity	Valid until	Certificate number	Comment
CE	Europe	unlimited		According to directive 2014/30/EU 2014/34/EU 2014/35/EU 2014/53/EU 2014/65/EU
ATEX	Europe	unlimited	UL 23 ATEX 2902X	
IECEX	Global	unlimited	IECEX UL 23.0007X	
NEC	USA	unlimited	UL-US-2421615-0	Report Reference: E202379-20240607
CE-Code	Canada	unlimited	UL-CA-2417306-0	
CCC	China	17.06.2029	2024312309000830	ORCA01E devices
			2024312309000829	ORCA01M devices
CNEx		11.06.2029	CNEx24.2504X	ORCA01E devices
			CNEx24.2503X	ORCA01M devices

The following approvals are only valid for ET devices:

Synonym	Scope of validity	Valid until	Device	Certificate number
PESO	India	31.12.2027	ORCA01E*	A/P/HQ/TN/104/6403 (P572175)

The following approvals only apply to the model versions listed in the tables:

Synonym	Scope of validity	Valid until	Certificate number
BIS	India	26.06.2026	R-41228087
Model version (Family code)			
ORCA01ETCS3DC0000			ORCA01ETCP4AC0000
ORCA01ETCS4DC0000			ORCA01ETCP4ACMM00
ORCA01ETCS6DC0000			ORCA01ETCP6AC0000
ORCA01ETCP4DC0000			ORCA01ETCP6ACMM00
ORCA01ETCP4DCMM00			ORCA01ETCP6ACMMC8
ORCA01ETCP6DC0000			ORCA01ETCP6ACSM00
ORCA01ETCP6DCMM00			ORCA01ETCP6ACSMC8
ORCA01ETCP6DCMMC8			
ORCA01ETCP6DCSM00			
ORCA01ETCP6DCSMC8			

The following approvals only apply to the model versions listed in the tables:

Synonym	Scope of validity	Valid until	Certificate number
DNV	Marine / ship approval	06.06.2029	TAA00003EU
Model version (Family code)			
ORCA01ETCP6AC0000			

1.5.3 Summary of applied standards**1.5.3.1 ATEX / IECEx**

Standard	Classification
IEC 60079-0 : 2018	General requirements
IEC 60079-5 : 2015	Protection by powder filling "q"
IEC 60079-7 : 2015 + A1 : 2018	Protection by increased safety "e"
IEC 60079-11 : 2012	Protection by intrinsic safety "i"
IEC 60079-31 : 2014	Protected by enclosures "t" (dust ignition protection)

1.5.3.2 EMC Directive 2014/30/EU

Standard	Classification
EN 61000-3-2 : 2014	Limiting values for harmonic current emissions
EN 61000-3-3 : 2013	Limiting values for voltage changes
EN 61000-6-2 : 2005 + AC : 2005	Immunity industrial areas
EN 61000-6-3 : 2007 + A1 : 2011 + AC : 2012	Emitted interference residential areas
EN 61000-6-4 : 2007 + A1 : 2011	Emitted interference industrial areas
EN 55035 2017 :	Immunity of multi-media devices
EN 55032 2015 :	Emitted interference of multi-media devices

1.5.3.3 Radio equipment directive 2014/53/EU

Standard	Classification
ETSI EN 300330 V2.1.1 : 2017-02	Short-range devices (SRD)
ETSI EN 301489-1 V2.2.3 : 2019-11	Technical requirements
ETSI EN 301489-3 V2.1.1 : 2019-01	Specific rating for short-range devices (SRD)

1.5.3.4 Low voltage directive 2014/35/EU



Standard	Classification
EN 62368-1 : 2014 + AC : 2015	Devices for audio / video, information and communication technology - safety requirements

1.5.3.5 RoHS Directive 2011/65/EU

Standard	Classification
EN IEC 63000 : 2018	Technical documentation for the assessment of electrical and electronic equipment with regard to the restriction of hazardous substances

2 Explanation of symbols

2.1 Symbols used in these Operating Instructions

Symbol	Meaning
	Useful hint for making work easier, important note
	Reference to another chapter, another section, another documentation or another web page.



2.2 Warning notes

	Dangerous situation which can result in fatal or severe, life-changing injuries if the safety measures are not complied with.
---	---









	Dangerous situation which can result in severe injuries if the safety measures are not complied with.
---	---

	Dangerous situation which can result in minor injuries if the safety measures are not complied with.
---	--

	Dangerous situation which can result in material damage if the safety measures are not complied with.
---	---

Symbol	Meaning
	Heat hazard
	Laser radiation hazard
	Electrostatic charge hazard

2.3 Symbols on the device

Symbol	Meaning
	Device certified for hazardous areas according to ATEX directive.
	Device marking according to EU directive
0158	ID number of monitoring body
	Marking according to WEEE directive 2012/19/EU
	Marking according to UL for approval in North America <ul style="list-style-type: none"> • C stands for Canada • US stands for United States
	Marking of devices according to BIS (BUREAU OF INDIAN STANDARDS) for approval in India
	Marking of devices according to CCC (China Compulsory Certification) for approval in China
	Warning - important information
	Warning of hazardous voltage
	Connection for equipotential bonding

3 Safety

The device has been manufactured according to the state of the art of technology while observing recognised safety-related rules. When using the device, it is nevertheless possible for hazards to occur to life and limb of the user or third parties or for the device, environment or material assets to be compromised.

Only use the device under the following conditions:

- If it is not damaged
- As intended, while remaining aware of safety and hazards
- In accordance with these operating instructions.

3.1 Intended use

The ORCA01 HMIs with the ORCA device platform are Panel-mount devices (PM) and Operator Stations (OS) suitable for industrial production in hazardous areas.

Depending on their version, the devices are certified for the following hazardous areas:

ORCA series	Hazardous area	Directive
E	Zone 1, 2, 21 and 22 (EPL Gb, Db)	ATEX directive, IEC
	Zone 1, 2, 21 and 22 Class I, II, III Division 2	CSA-C22.2 No.60079-0
	Class I, Zone 1, Zone 21 & 22 Class I, II, III Division 2	UL 60079-0
M	Zone 2 and 22 (EPL Gc, Dc)	ATEX directive, IEC
	Zone 2 and 22 Class I, II, III Division 2	CSA-C22.2 No.60079-0
	Class I, Zone 2, Zone 22 Class I, II, III Division 2	UL 60079-0

The ORCA device platform has been developed for process and machine operation in the pharmaceutical, chemical, food, biotech and life science industries. The device can be used indoors as well as in protected outdoor areas.

The approved operating temperature ranges depend on the version:

- Panel-mount device: from -20 °C to +55 °C
- Operator Station: from -20 °C to +50 °C

Depending on their configuration, the following versions with the ORCA device platform are available:

- Panel PC - Thin Clients
- Direct Monitor

The ORCA device platform consists of a display and an E-Box module that are usually installed together. The display module mostly consists of all display components, whereas the E-Box module mostly consists of the other electronic parts.

For service and repair (replacement) purposes the modules can be supplied separately. The conditions listed in chapter [12.4.1 Mounting / dismantling the modules](#) apply.

The ORCA device platform communicates with automation systems and distributed control systems via Ethernet or a serial interface, and has additional USB interfaces for peripherals such as keyboards, pointing devices, RFID readers, barcode readers for material inventory or an EM-STOP button.

A connection box with separate compartments for Ex e and Ex ia circuits is used for the connection of all external cables.

The devices can be mounted into the cut-out of enclosures according to IEC 60079-0 or into enclosures with protection type Ex eb or ec, Ex tb or tc, or Ex p. They meet the requirements of each of these enclosures up to IP65 according to IEC 60079-0.

"Intended use" includes complying with these operating instructions and other applicable documents, e.g. the data sheet. All other uses are only considered to be intended after being approved by R. STAHL.

3.2 Predictable improper use

The device may only be installed and connected by qualified or specifically trained personnel.

3.3 Personnel qualification

Qualified specialist personnel is required to perform the activities described in these operating instructions. This primarily applies to work in the following areas:

- Product selection and project engineering
- Mounting / dismantling the device
- Installation
- Commissioning
- Maintenance, cleaning

Specialists who perform these tasks must have a level of knowledge that meets applicable national or equivalent country-specific standards and regulations. Additional knowledge is required for any activity in hazardous areas !

R. STAHL recommends having a level of knowledge equal to that described in the following standards:

- IEC/EN 60079-14 (Electrical installations design, selection and erection)
- IEC/EN 60079-17 (Inspection and maintenance of electrical installations)
- IEC/EN 60079-19 (Equipment repair, overhaul and reclamation)

3.4 Special conditions of use

The intrinsically safe circuits are earthed.

The devices (including their connection cables) may only be installed in areas where there are absolutely no intensive electrostatic charge processes.

For ORCA01M* only:

The devices are intended for installation in areas with degree of pollution of at least 2 according to IEC 60664-1.

An overvoltage protector must be fitted that is set to a value of no more than 140 % of the peak value of the nominal voltage at the supply connections of the device.



Please refer to the certificates for more special conditions.

3.5 Residual risks

3.5.1 Explosion hazard

Despite the device's state-of-the-art design, explosion hazards cannot be entirely eliminated in hazardous areas.

- Perform all tasks in hazardous areas with the utmost care at all times !

Possible hazards ("residual risks") can be categorised according to the following causes:

Mechanical damage

The device may become damaged during transport, mounting or commissioning. This kind of damage may, for example, render the device's explosion protection partially or completely ineffective. This may result in explosions causing serious or even fatal injury.

- Do not commission a damaged device.
- Only transport the device in special transport packaging that reliably protects the device from external influences. Take ambient conditions into account when selecting the transport packaging (see chapter [17.1 Technical data](#)).
- Do not place any loads on the device.
- Check the packaging and the device for damage. Immediately report any damage to R. STAHL.
- Store the device ideally in its original packaging in a dry place (with no condensation) and make sure that it is stable and protected against the effects of vibrations and knocks.
- Do not damage the device or seals during its installation.

Excessive heating or electrostatic charge

- Operate the device only within the prescribed operating conditions (see chapters [4.9 Markings on the device](#) and [17.1 Technical data](#)).
- Mount and install the device in such a way that it is always operated within the permissible temperature range.
- Do not use the device in strong charge-generating environments.
- Avoid friction and flow of particle streams.

- R. STAHL recommends you equip devices used outdoors or exposed to the elements with a protective roof or wall.
- Regularly inspect the device for a material change. If you spot any changes, test or replace the device.
- Do not paint or repaint the device yourself. Do not have the paintwork touched up by anyone other than the manufacturer.
- Comply with the area specification of EN/IEC 60079-0 when fitting additional plastic adhesive labels.
- Clean the device with a damp cloth only.
- Do not cover the display with protective foil.

Improper mounting, installation, commissioning, maintenance or cleaning

Basic work such as installation, commissioning, maintenance or cleaning of the device must always be performed in accordance with the applicable national regulations of the country of use and only by qualified persons. Otherwise, the explosion protection may be rendered ineffective. This may result in explosions causing serious or even fatal injury.

- Have the assembly, installation, commissioning and maintenance work performed by qualified and authorised persons only (see chapter [3.3 Personnel qualification](#)).
- Prior to commissioning, check the device is correctly mounted (see chapter [8 Mounting and installation](#)).
- Electrical circuits with Ex i type of protection may no longer be operated as electrical circuits with this type of protection after being operated with electrical circuits with other types of protection.
- Even when used in Zones 2 and 22, intrinsically safe devices of Zones 0, 1, 20 and 21 can be connected to the intrinsically safe signal circuits.
- Only connect the device to equipment which does not carry voltages higher than 250 VAC (50 - 60 Hz).
- Connect Ex i devices only to intrinsically safe terminals.
- In hazardous areas, always switch the electrical circuits and devices to a de-energised state before disconnecting or connecting and when mounting / dismantling.
- Do not change or modify the device.
- Any repair on the device is to be performed by R. STAHL only.
- Gently clean the device with a damp cloth only – do not use scratching, abrasive or aggressive cleaning agents or solutions.
- Never clean the device with a strong water jet, such as a pressure washer !
- The device protection may be compromised if the device is being used outside of its intended purpose as specified by the manufacturer.

3.5.2 Risk of injury

Falling devices or components

The heavy device or components can fall during transport and mounting, causing severe injury to persons in the form of bruises and contusions.

- Use transporting and lifting equipment suitable for the size and weight of the device when transporting and mounting it.
- Observe the weight and the maximum load-bearing capacity of the device; see specifications on the shipping label or on the packaging.
- Use suitable mounting materials for mounting.

Electric shock

During operation and maintenance, high voltage is at times applied to the device. Because of this, the device must be de-energised during installation. Persons coming into contact with electrical lines carrying excessively high voltage can suffer severe electric shocks and, consequently, injuries.

- Only connect electrical circuits to suitable terminals.

3.5.3 Device damage

As a result of unsuitable operating conditions or careless handling the device or individual components may be damaged so significantly that the device does not operate correctly or fails completely.

- Do not subject the device to external heat sources or direct sunshine. Ensure that the maximum ambient temperature is never exceeded.
- Do not open the enclosure. The enclosure has been sealed permanently.

3.6 Industrial Security

Our products with Industrial Security functions support the secure operation of facilities, systems and equipment. Protection against cyber threats requires an all-encompassing Industrial Security concept. The key to a successful concept is integrated implementation, continuous maintenance and state-of-the-art technology. This is the responsibility of the facility operator.

The following are key issues for effective industrial security concepts:

- Prevention of unauthorised access to facilities, systems, equipment and networks
- Systems, equipment and components should only be connected to the company intranet or the internet if and when required
- Employ protective measures such as firewalls and network segmentation
- Only use the latest software product versions
- Carry out software updates as soon as new updates are available
- Use standard user accounts for regular operation
- Use secure passwords
- Appropriate safeguarding of administrator accounts
- Application of security guidelines
- Other measures to be taken as required

R. STAHL uses Windows 10 for its products. The company does not develop any cryptographic functions. Neither does the company create any system configuration / system hardening software, provide security guidelines for these, nor does it refer to any such guidelines.

Moreover, R. STAHL is constantly working on enhancing its products, thereby contributing to system security and to minimizing the risk of cyber threats.

4 Function and device design

4.1 Features and versions

4.1.1 Options

The HMIs with the ORCA device platform are Panel-mount devices (PM) and Operator Stations (OS) that have been developed for process and machine operation in the pharmaceutical, chemical, food, biotech and life science industries.

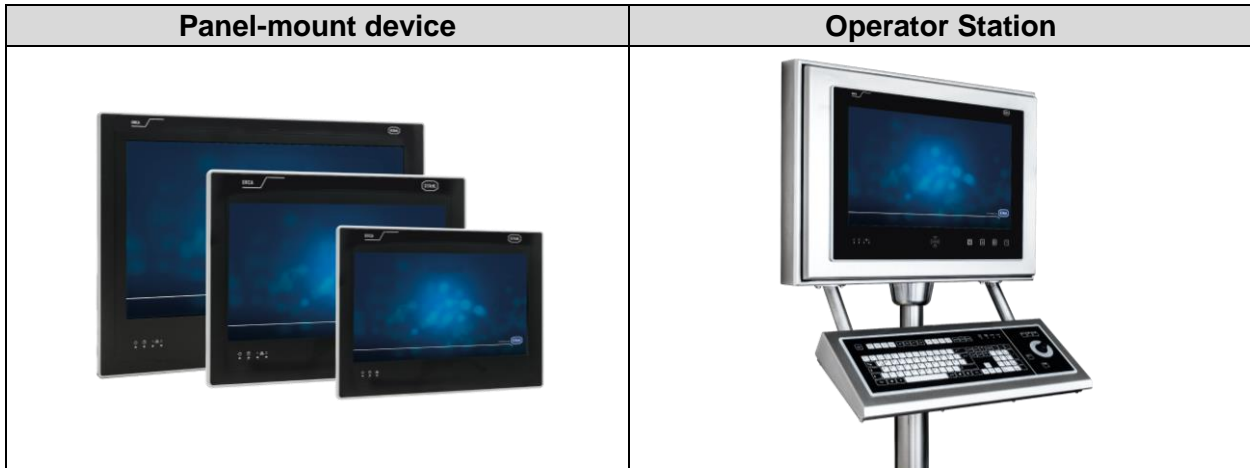

Depending on their technology, the devices perform the following tasks:

Technology	Task
Panel PC / Thin Client	Industrial PC with computer and monitor or Thin Client for remote control of PCs or virtual workstations, for example via Ethernet and WiFi.
Direct Monitor (USB) (only 22" display)	Extension of the primary screen for a dual-screen solution via a USB connection, requiring driver support at the main device.

4.1.2 Panel-mount device

The Panel-mount devices consist of a display box (D-Box) and an electronics box module (E-Box) that are installed together. The display box module mostly consists of all display components, whereas the E-Box module mostly consists of the other electronic parts.

4.1.2.1 D-Box

The ORCA device platform is available with the following types of display:

- Size: 12", 15" or 22"
- Multi-touch function
- Dimmable (via the operating system and, for the 22" model, also via sensor keys)

Optional components:

- Integrated PC/SC card reader (only 22" display)
- Stick-on card holder, for devices with integrated card reader

4.1.2.2 E-Box

Available E-Boxes are:

- E-Box Standard, with
DC supply, Intel® ATOM™ processor, copper Ethernet interface
- E-Box PRO, with
AC or DC supply, Intel® ATOM™ or Intel® Core i5™ processor, optional with two
copper / fibre optic Ethernet interfaces

4.1.2.3 Combination options of D-Box and E-Box

Display size D-Box	E-Box Standard	E-Box PRO
12"	X	-
15"	X	X
22"	X	X
22" (Direct Monitor)	-	X

4.1.3 Operator Station

The 22" Operator Stations are specifically intended for the process industry. This means both the installation in production areas where there is a lot of dirt and pollution, and the installation in class C cleanrooms.

All Operator Stations have a 22" display box and either the E-Box Standard or the E-Box PRO. These Panel-mount devices are installed in a type ORCA-OFR enclosure with GMP-compliant design.

These Operator Stations can be installed as single as well as dual-screen solutions.

Further features of the enclosure:

- Waterproof and dust-tight IP66
- V2A or V4A stainless steel enclosure
- Easily accessible via front door with GMP gasket

Optional components:

- Enclosure version FR, CFR, BD
- Sun roof for FR and CFR enclosure
- Intrinsically safe KB2 keyboard with trackball, touchpad or joystick
- Prepared for operation of Barcode scanner (pre-wired) (Barcode scanner to be ordered separately)
- On / off button, installation switch 8040/11-V30
- WLAN, Bluetooth adaptor

4.1.3.1 Card reader for access control

As an option, the 22" ORCA01* devices can be fitted with an integrated card reader. This card reader is a proximity reader that can read the corresponding transponder media without direct contact and transfer the data to operating devices or any other systems.

In addition, all ORCA01* devices can be fitted with STAHL's proprietary UB03 card reader via USB. For this, the PM devices have to be installed inside an enclosure.

Three versions of RFID reader are available for different types of data transfer between reader and a corresponding software.

Internal card readers (in D-Box):

- PC/SC - version C8: PC/SC is a platform and manufacturer-independent standard for card readers with access to smartcards. PC/SC stands for "personal computer / smart card". Internally, the module is connected via a USB interface.

External UB03 card reader as accessory (at Operator Station):

- CRYPT - version C5: data is transferred via an encrypted bidirectional protocol. This protocol can also be used to describe the transponder media. The connected device must be able to support the data encryption via a suitable application. The protocol description can be provided once a confidentiality agreement has been signed.
- ASCII - version C6: when the transponder medium approaches the reader or is removed from it, the reader actively sends the pre-parameterised content of the medium in the form of characters transformed byte-wise from hex code to ASCII. Applications such as PM Logon from Siemens or LogOnPlus from i.p.a.s. support this protocol.

In addition, for the RFID reader a card holder is available, which is glued to the ORCA device or at the reader itself.

4.1.4 Accessories

Peripherals:

- Barcode scanner
- UB03 Card reader
- Attached KB2 keyboard and pointing device (trackball, joystick or touchpad (Ex ia))
- On / off button
- Installation switch 8040/11-V30
- WLAN, Bluetooth adaptor

The accessories are connected in the connection box (see chapter [4.6 Connection box](#)).



For associated Operating Instructions see r-stahl.com.

4.1.5 Scope of delivery

4.1.5.1 Panel-mount device

- ORCA01* Panel-mount device according to ordered configuration
- Mounting frame including pre-assembled screws
- Cable glands as a set for E-Box Standard or E-Box PRO (depending on Panel-mount device configuration)
- Touch pen
- USB stick (with documentation and image) – cannot be used in hazardous areas
- USB adaptor board (for commissioning purposes) – cannot be used in hazardous areas



- Operating Instructions

4.1.5.2 Operator Station

- ORCA01* Operator Station according to ordered configuration, completely wired and ready for operation
- Cable glands as a set for E-Box Standard or E-Box PRO (depending on Operator Station configuration)
- Touch pen
- USB stick (with documentation and image) – cannot be used in hazardous areas
- USB adaptor board (for commissioning purposes) – cannot be used in hazardous areas



- Operating Instructions

4.2 Device design

4.2.1 Panel-mount device

Taking the 15" device with E-Box Standard as an example:

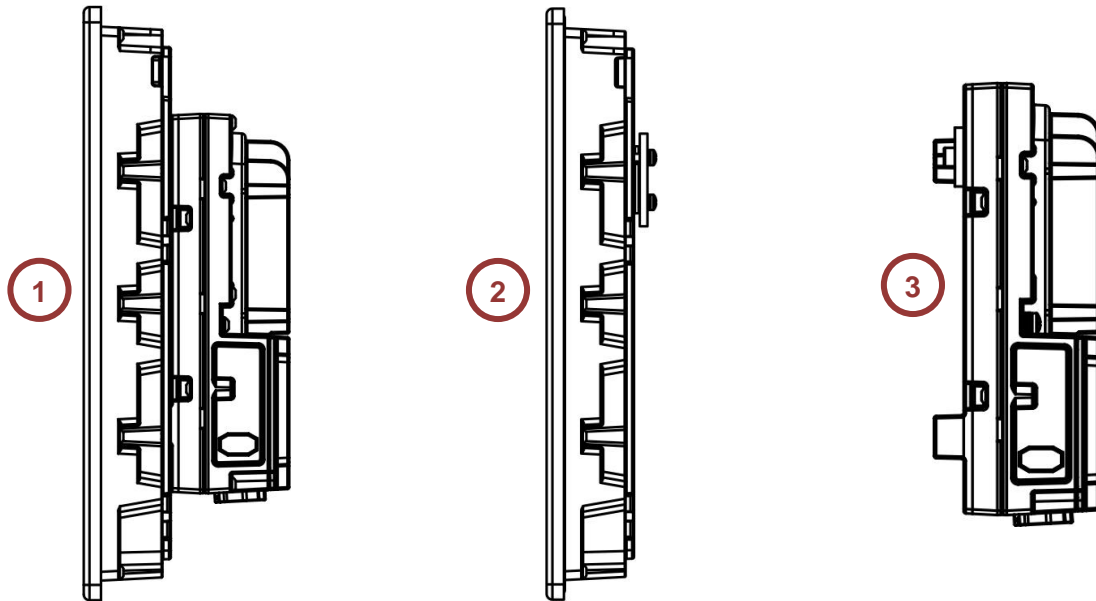

Item	Designation
1	ORCA01* 15" device with E-Box Standard
2	15" display box (D-Box)
3	E-Box Standard

4.3 Type code

4.3.1 Family code

The family code contains all information relevant for certification.

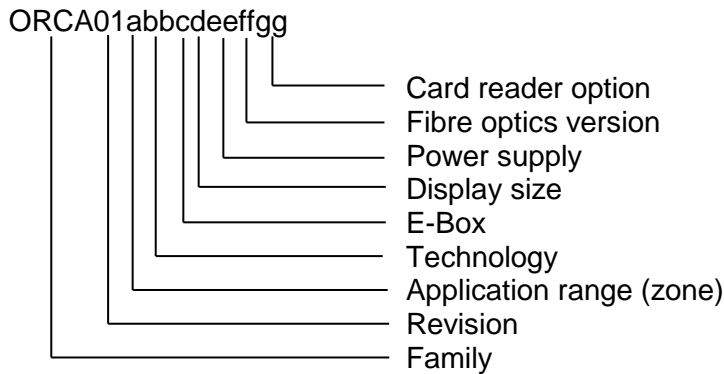

Family code digit	Possible value	Description
ORCA	ORCA	Family designation
01	01	Family hardware revision
a	E	Devices for Zone 1, Zone 21, EPL Gb, Db
	M	Devices for Zone 2, Zone 22, EPL Gc, Dc
	I	Devices for safe areas, Non-Ex
bb	00	No technology
	TC	Thin Client / Panel PC
	DM	Direct Monitor
c	0	no E-Box
	S	E-Box Standard
	P	E-Box PRO
d	0	no display
	3	Display size 3 (12")
	4	Display size 4 (15")
	6	Display size 6 (22")
ee	00	no power supply
	AC	AC power supply
	DC	DC power supply
ff	00	no fibre optic
	MM	multi-mode fibre optic
	SM	single mode fibre optic
gg	00	no card reader
	C8	RFID PC-SC card reader

4.3.2 Type key code field system

Field systems					
Definition Field systems	<p>A field system consists of at least one HMI unit and its integrated software. If the HMI unit is mounted inside an enclosure, this enclosure as well as all other accessories mounted inside it are part of the field system. To facilitate the order-process for a field system, a product code was developed that can reproduce all possible combinations of device, software, enclosure and accessories. This product code consists of alpha-numerical characters and may look as follows: E59A10T02-C50C3000000221-1012000000000Y This example is valid for a Panel PC / Thin Client system; the product codes for all other field systems are built in the same way.</p>				
	It is decoded as follows:				
Decoding	E59A10T02	-	C50C3000000221	-	10120000000000Y
Meaning	Device version	Hyphen	extended device version	Hyphen	Enclosure and accessories
	For an exact definition of each individual character please refer to the type code for field systems on the following pages.				
	<p>A field system can only be ordered with a valid and plausible product code. For this, all digits of the product code must be filled with a valid character. Please also note that for technical reasons not all theoretically possible product codes and thus field systems can actually be realised. Should you have any questions in this regard, please contact R. STAHL HMI Systems GmbH.</p>				

Position in type key	Meaning	Possible value	Description
1	Application range (zone)	E	Devices for Zone 1, Zone 21, EPL Gb, Db
		M	Devices for Zone 2, Zone 22, EPL Gc, Dc
2	Technology	0	Display-Box (stand-alone)
		5	Thin Client / Panel PC
		7	Direct Monitor
3	Display size	0	no display, only E-Box (stand-alone)
		2	12" / 30.8 cm display, 1280 x 800 pixels
		4	15" / 39.5 cm display, 1920 x 1080 pixels
		9	22" / 55 cm display, 1920 x 1080 pixels
4	Platform	A	ORCA platform
5	Hardware revision	1	Hardware revision rev 1
6	Basic option 1	0	no option
7	Interface medium	0	no interface
		T	1x 1000Base-TX Copper Ethernet
		F	1x 100Base-FX FO Ethernet, multi-mode
		S	1x 1000Base-SX FO Ethernet, multi-mode
		L	1x 1000Base-LX FO Ethernet, single mode
		E	Ethernet extender
8	Interface medium 2	0	no interface
		F	1x 100Base-FX FO Ethernet, multi-mode
		S	1x 1000Base-SX FO Ethernet, multi-mode
		L	1x 1000Base-LX FO Ethernet, single mode
		U	Additional USBc interface

9	E-Box Option	0	no E-Box
		1	E-Box Standard
		2	E-Box PRO
		3	E-Box PRO, Direct Monitor
10	Hyphen	-	Hyphen
11	Processor type	0	no processor
		B	Intel® ATOM™ E3940
		C	Intel® Core i5™ 8365UE
12	Main memory (RAM)	0	no main memory
		3	4 GB (ATOM)
		4	8 GB (ATOM)
		5	16 GB (i5)
		6	32 GB (planned for future)
13	Display type	0	Standard TFT
		1	Sunlight readable (planned for future)
14	Data memory	0	no data memory
		A	64 GB SSD (ATOM)
		9	128 GB SSD (ATOM)
		C	256 GB SSD (i5)
		E	480 GB SSD (planned for future)
15	Touchscreen	0	no touch screen
		3	Projected capacitive (PCAP), multi-touch
16	Power supply	N	no power supply
		0	DC power supply 24 VDC
		1	AC power supply 85 - 250 VAC
17	Optional Interfaces 1 (WiFi, Bluetooth)	0	no WiFi, no Bluetooth
18	Optional Interfaces 2 (internal card reader)	0	no card reader
		8	RFID card reader PC-SC
19	Optional Interfaces 3 (Audio)	0	no audio
		1	USBc interface
		5	Audio amplifier output
20	Additional options	0	no additional option
		1	Direct Monitor
		2	Standard (Thin Client / Panel PC)
21	Front design	0	Standard
22	Front plate special version	0	no front plate
		1	neutral
		2	STAHL

23	Operating system	0	No operating system
		1	WIN10 IoT Enterprise LTSC 2019 32Bit
		2	WIN10 IoT Enterprise LTSC 2019 64Bit
		3	PXE-Boot (for ThinManager)
		4	IGEL OS 11 (does not include license)
		8	WIN10 IoT Enterprise LTSC 2021 64Bit
24	Image	0	no image
		1	OS STAHL
		3	Remote V6 STAHL
		5	Movicon Power HMI 2048
		6	IGEL OS 11
		8	Remote V7 STAHL
25	Hyphen	-	Hyphen
26	Enclosure version	0	no enclosure, no options
		1	ORCA-OFR Operator Station (22" device only)
		2	ORCA FR Operator Station
		3	ORCA CFR Operator Station
		7	ORCA BD Operator Station
27	Enclosure option	0	no enclosure option - standard
		1	SL (Slim) enclosure (reduced enclosure depth)
		8	Sun roof (FR and CFR enclosure only, 22" device only)
28	Enclosure material	0	no enclosure material
		1	V2A SS304 stainless steel
		2	V4A SS316L stainless steel
29	Enclosure mounting type	0	no enclosure mounting
		1	Wall mounting
		2	Mounted on stand or elbow below
		3	Mounted at ceiling or elbow on top
30	Outdoor Installation	0	no outdoor installation – indoor only
		3	Protected outdoor area (breather available)
31	Keyboard (layout)	0	no keyboard, no keyboard enclosure
		D	Keyboard in keyboard enclosure with keyboard layout German - DE (QWERTZ)
		E	Keyboard in keyboard enclosure with keyboard layout American - US (QWERTY)
		F	Keyboard in keyboard enclosure with keyboard layout French - FR (AZERTY)
		G	Keyboard in keyboard enclosure with keyboard layout Swiss German - CH
		H	Keyboard in keyboard enclosure with keyboard layout Spanish - ES
		I	Keyboard in keyboard enclosure with keyboard layout Slovenian - SL
		J	Keyboard in keyboard enclosure with keyboard layout Japanese - JP

		K	Keyboard in keyboard enclosure with keyboard layout Nordic (Swedish, Finnish, Norwegian, Danish)
		U	Keyboard in keyboard enclosure with keyboard layout Hungarian - HU
		B	Keyboard matrix
32	Integrated pointing device	0	no integrated pointing device in keyboard enclosure
		1	Trackball in keyboard enclosure
		4	Touchpad in keyboard enclosure
		5	Joystick in keyboard enclosure
33	Optional devices 1	0	no optional devices
		1	WLAN and Bluetooth adaptor
		2	WLAN adaptor
		3	Bluetooth adaptor
		4	Installation switch
		5	WLAN and Bluetooth adaptor, installation switch
		6	WLAN adaptor at enclosure top, installation switch
		7	Bluetooth adaptor at enclosure bottom, installation switch
34	Readers 1 (versions)	0	no reader 1
		5	UB03-xxx-C05-USB (CRYPT) card reader
		6	UB03-xxx-C06-USB (ASCII) card reader
35	Readers 1 (position)	0	no reader 1
		1	Reader in enclosure, right-hand side
		2	Reader in enclosure, left-hand side
		3	Reader at keyboard enclosure, right-hand side
36	Control devices	0	no control device
		1	EM-STOP in enclosure, right-hand side
		2	EM-STOP in enclosure, left-hand side
		3	EM-STOP in enclosure, front side, middle, bottom
37	Readers 2 (versions)	0	no reader 2
		1	Wired barcode scanner (BCR-IDM x6x) (with VM125-ex power supply)
		2	Bluetooth barcode scanner (BCR-IDMBT x6x) (with VM125-ex power supply)
		3	Wired 2D barcode scanner (BCR-IDM 26x) (with VM125-ex power supply)
		4	Bluetooth 2D barcode scanner (BCR-IDM 26x) (with VM125-ex power supply)
38	Readers 2 (position)	0	no reader 2
		1	Reader at enclosure, right-hand side
		2	Reader at enclosure, left-hand side
		3	Reader at keyboard enclosure

39	Further options (inside enclosure)	0	no further options inside enclosure
		1	Y-Purged with barrier (FR, CFR enclosures)
		2	USB Plug downwards (FR, CFR enclosure)
		3	USB Plug front side right
40	Other markings	Y	Marking for new field system code
		L	Marking for loan device
		Z	Marking for field system with document drawing number
		S	Marking for field system fitted with replacement parts

4.4 Available configuration versions

Variant	E-Box	Power supply	Processor type	Main memory	Data memory	Ethernet / Data
E52A M52A	Standard	24 VDC	ATOM E3940	up to 16 GB	up to 256 GB	10/100/1000Base-TX
E54A M54A	Standard	24 VDC	ATOM E3940	up to 16 GB	up to 256 GB	10/100/1000Base-TX
	PRO	24 VDC or 230 VAC	ATOM E3940 or Intel Core i5	up to 16 GB	up to 256 GB	10/100/1000Base-TX
						2x 10/100/1000Base-TX
						10/100/1000Base-TX + 1x 100Base-FX
						10/100/1000Base-TX + 2x 1000Base-SX
10/100/1000Base-TX + 2x 1000Base-LX						
E59A M59A	Standard	24 VDC	ATOM E3940	up to 16 GB	up to 256 GB	10/100/1000Base-TX
	PRO	24 VDC or 230 VAC	ATOM E3940 or Intel Core i5	up to 16 GB	up to 256 GB	10/100/1000Base-TX
						2x 10/100/1000Base-TX
						10/100/1000Base-TX + 1x 100Base-FX
						10/100/1000Base-TX + 2x 1000Base-SX
10/100/1000Base-TX + 2x 1000Base-LX						
E79A M79A	PRO	24 VDC or 230 VAC	-	-	-	-

4.5 Dimensions

4.5.1 Panel-mount devices

4.5.1.1 Front

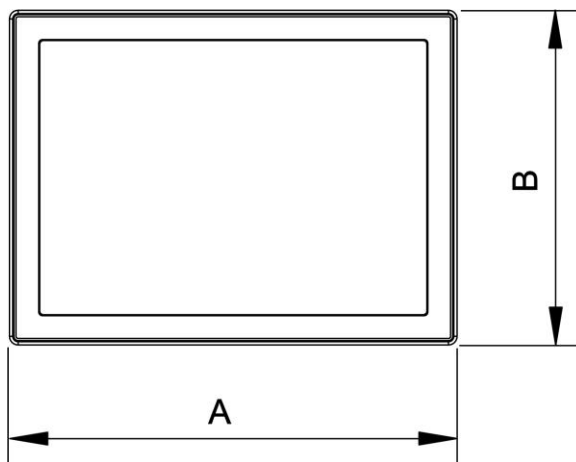

Dimensions (mm)			
Item	E/Mx2A	E/Mx4A	E/Mx9A
A	330	415	565
B	241	310	400

4.5.1.2 Side

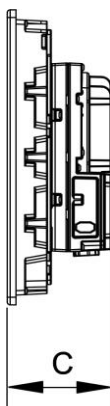

Dimensions (mm)			
Item	E/Mx2A	E/Mx4A / E/Mx9A with E-Box Standard	E/Mx4A / E/Mx9A with E-Box PRO
C	101	108	117

4.5.1.3 Cutout

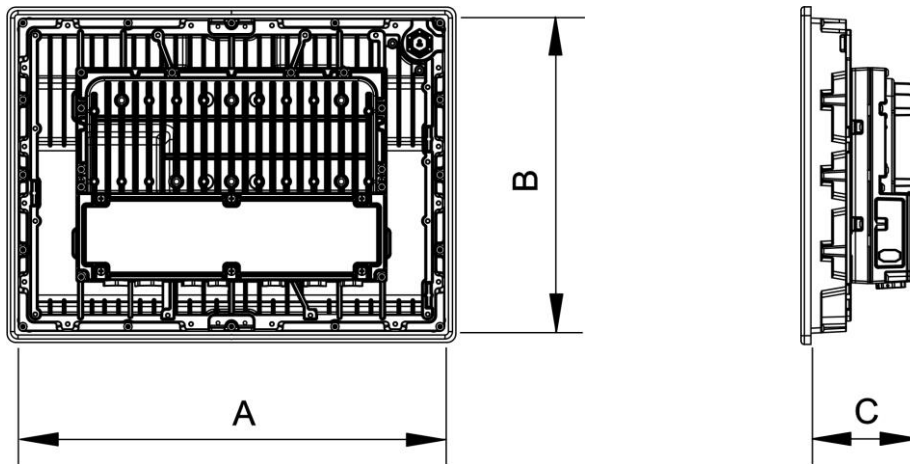

Dimensions (mm)					
Item	E/Mx2A	E/Mx4A with E-Box Standard	E/Mx4A with E-Box PRO	E/Mx9A with E-Box Standard	E/Mx9A with E-Box PRO
A	310	396		547	
B	221	291		382	
C	92	98	108	99	108
Cut-out tolerances [mm]					
	+1.0 mm / -0.5 mm			+-0.5 mm	

4.5.2 ORCA-OFR Operator Station

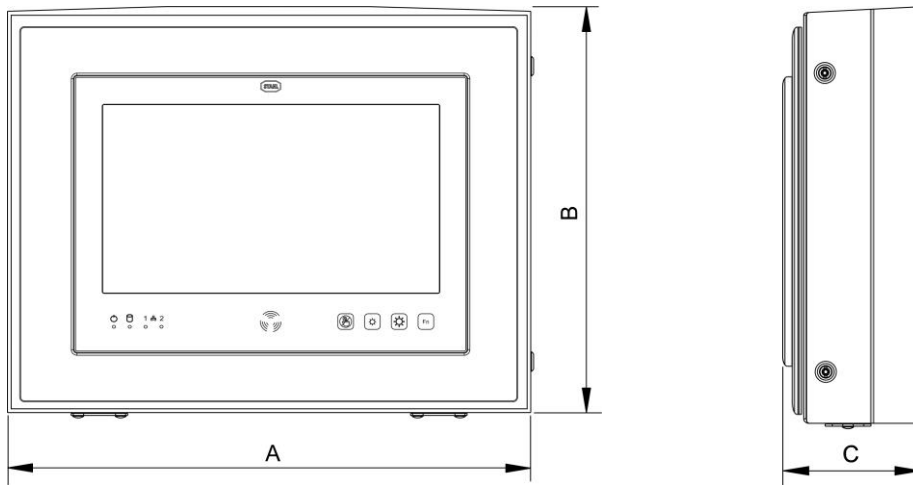

Dimensions (mm)		
A	B	C
708	524	176

4.5.3 ORCA-OFR Operator Station with keyboard

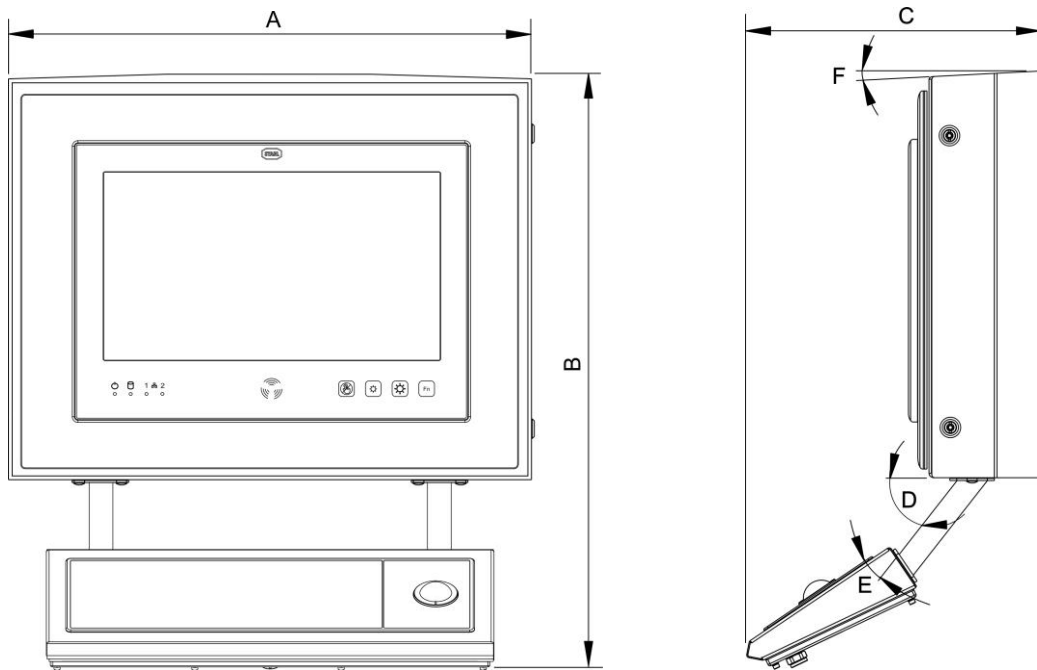

Dimensions (mm)					
A	B	C	D	E	F
708	794	404	52°	18°	5°

4.5.4 ORCA-FR Operator Station with sun roof

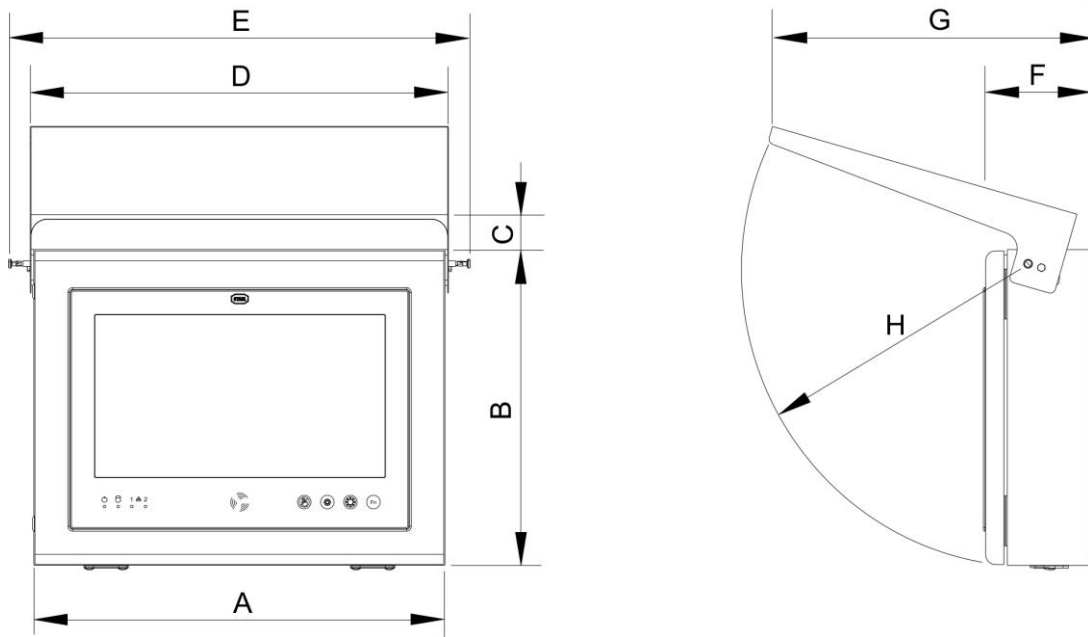

Dimensions [mm]							
A	B	C	D	E	F	G	H
740	568	64	753	831	190	574	R = 547

4.5.5 ORCA-FR Operator Station with keyboard and sun roof

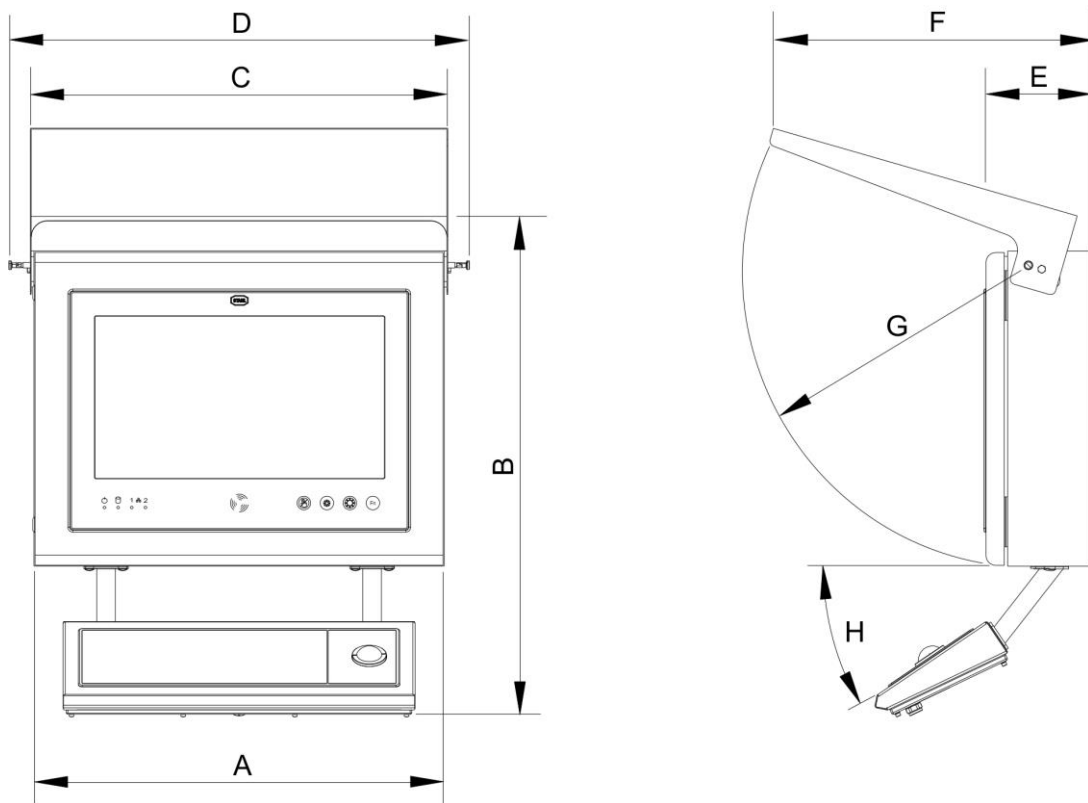

Dimensions [mm]							
A	B	C	D	E	F	G	H
740	899	753	831	190	574	R = 547	34°

4.6 Connection box

4.6.1 E-Box Standard

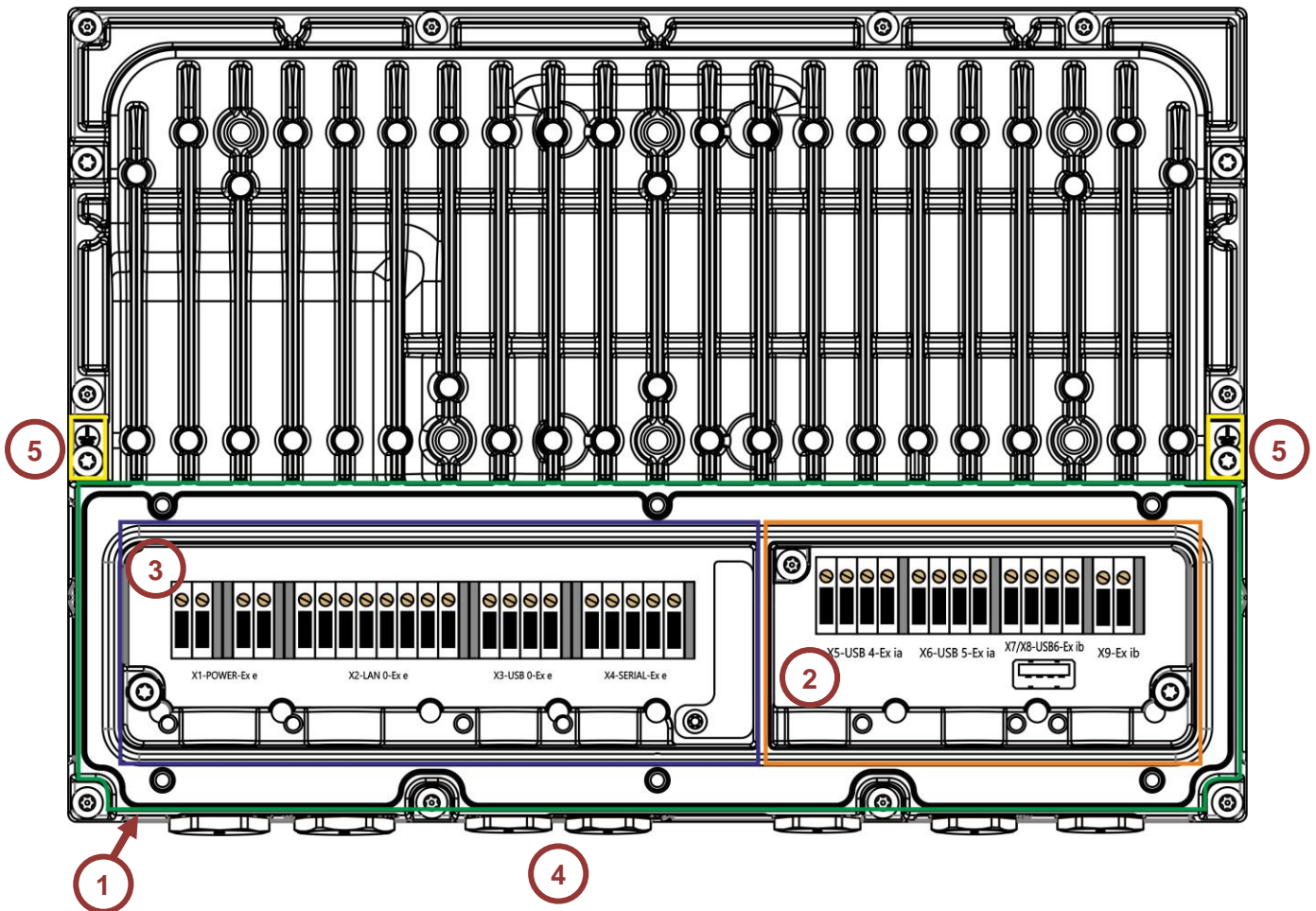

Item	Designation
1	Cover of connection box (removed in picture, circled in green)
2	Ex i Connection terminals (circled in orange)
3	Ex e Connection terminals (circled in blue)
4	Screws plugs (picture shows delivery status)
5	M4 Ground connections

 Cable glands (number, size, etc.) see [17.3 Cable glands](#)

4.6.2 E-Box PRO

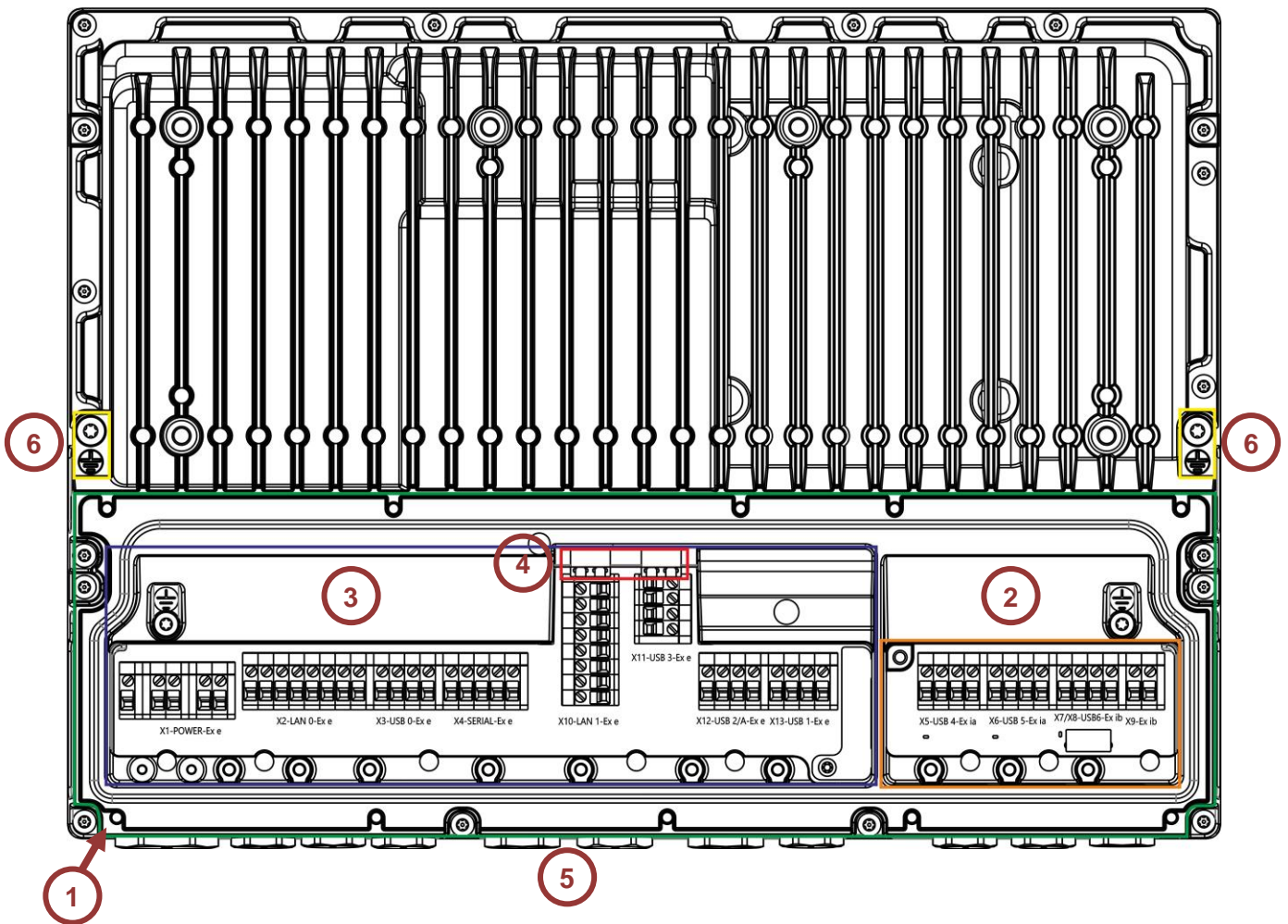

Item	Designation
1	Cover of connection box (removed in picture, circled in green)
2	Ex i Connection terminals (circled in orange)
3	Ex e Connection terminals (circled in blue)
4	Fibre optic connectors (optional) (circled in red)
5	Cable glands (picture shows delivery status)
6	M5 Ground connections



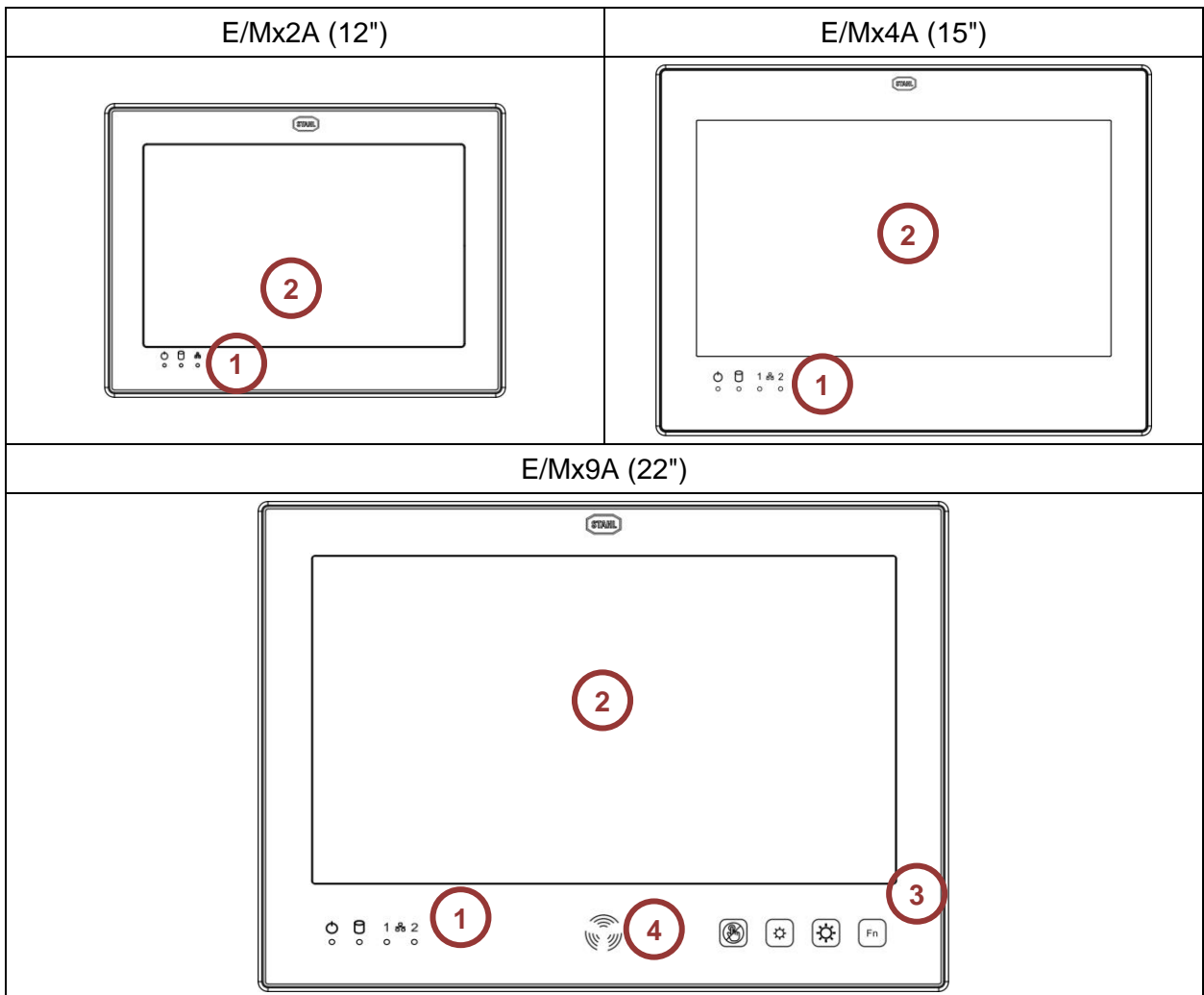

 Cable glands (number, size, etc.) see [17.3 Cable glands](#)

4.7 Operating elements











Item	Designation
1	LEDs
2	Display
3	Sensors 1 to 4
4	RFID card reader (optional)

4.7.1 Sensors

Pictogram	Meaning	Description
	Disable touch	Disables the touch function of the device. Press key for 2 seconds. Key lights up orange when touch is deactivated.
	Brightness adjustment	"Darker" key to reduce the backlight brightness
	Brightness adjustment	"Brighter" key to increase the backlight brightness
	Function key	Freely assignable function key. Set as F8 as standard.

 The keys briefly light up when pressed.

4.8 LED status display

Pictogram	LED colour	Status	Meaning
	 orange	lit	Device is live. Internal power supply ok. Device switched off.
	 white		HMI device in operation.
	 white	flashing	Accessing system disk (Solid State, HDD)
 or 1  2	 white *	off	no connection / no activity at Ethernet port
		lit	Existing connection at Ethernet port
		flashing	Activity at Ethernet port

 If the device contains both FO interfaces (modules), the LEDs will show the activity at the FO Ethernet ports.
There will be no display for the onboard copper interface.

4.9 Markings on the device

4.9.1 Position

4.9.1.1 Field system label

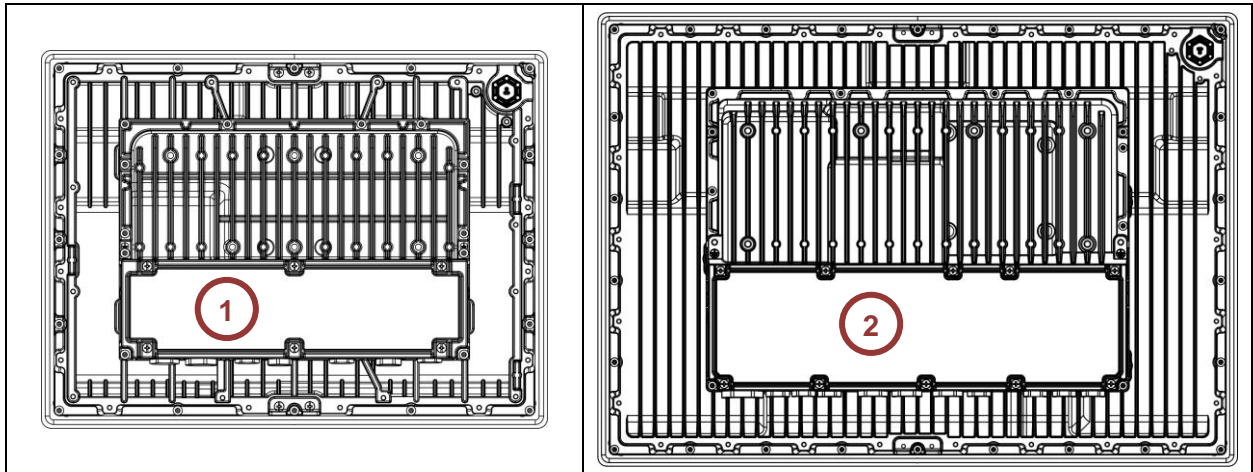

Item	Designation
1	Two-part PM field system type plate on E-Box Standard
2	Three-part PM field system type plate on E-Box PRO

4.9.1.2 Label on E-Boxes

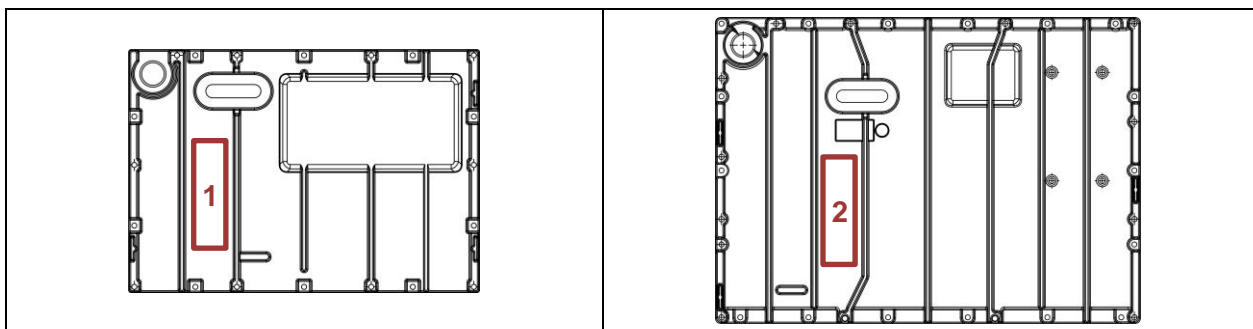

Item	Designation
1	Label on inside of E-Box Standard
2	Label on inside of E-Box PRO

4.9.1.3 Label on display boxes

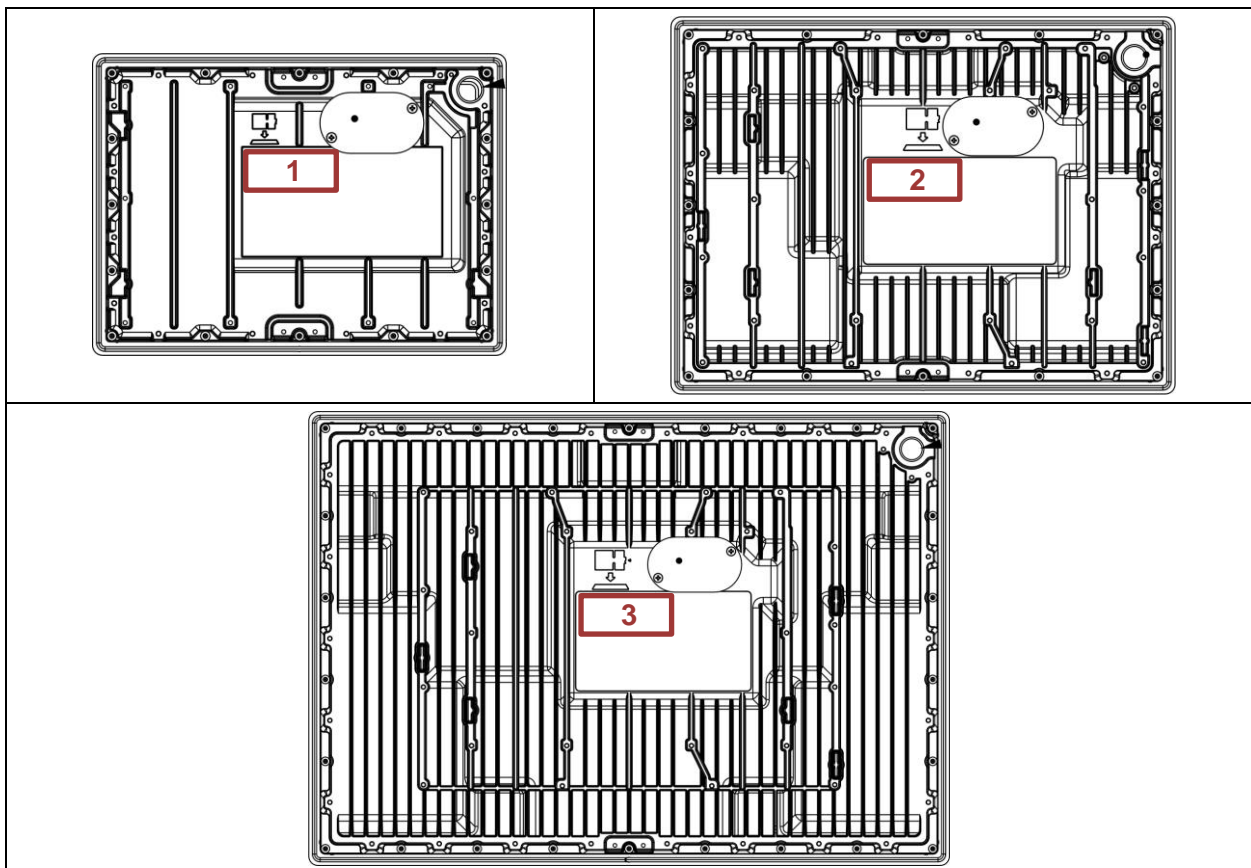

Item	Designation
1	Label on back of 12" display box
2	Label on back of 15" display box
3	Label on back of 22" display box

4.9.1.4 Warning label

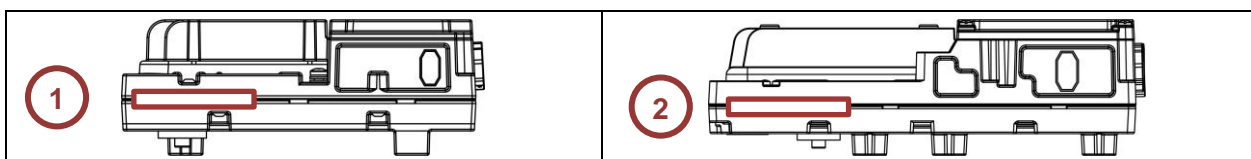

Item	Designation
1	Warning label on E-Box Standard, both sides, multilingual
2	Warning label on E-Box PRO, both sides, multilingual

! Text of warning label for DE and EN:
 Nicht öffnen. Dieses Gehäuse wurde dauerhaft verschlossen und kann nicht repariert werden. Warnhinweis – nicht in einem Bereich öffnen, warten oder Instand setzen, in dem eine explosionsfähige Atmosphäre vorhanden sein kann.
 Do not open. This container has been permanently sealed and cannot be repaired.
 Warning – Do not open, maintain or service in an area where an explosive atmosphere may be present.

Type plate section:

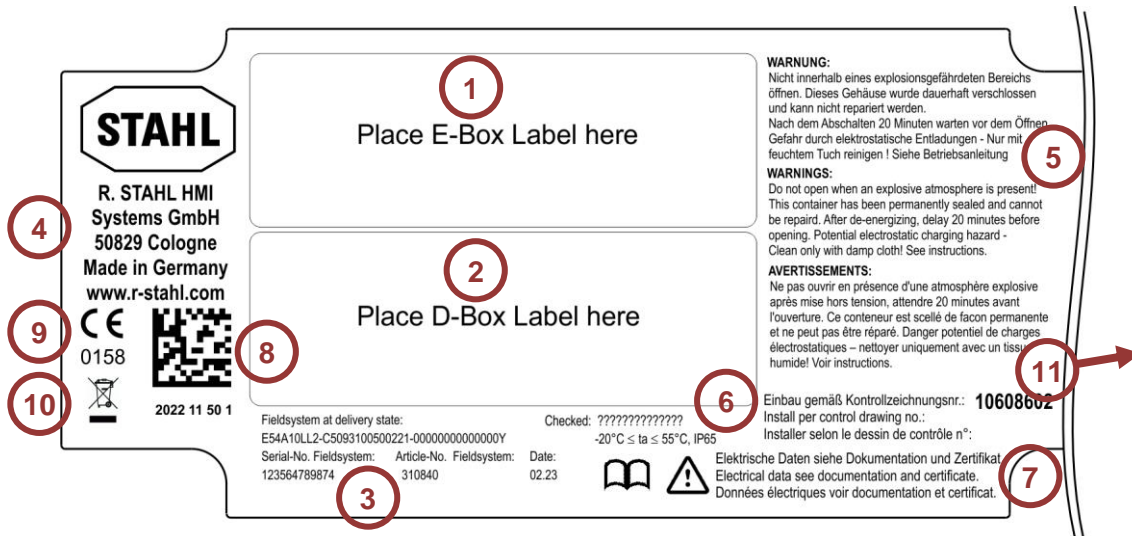

Item	Designation
1	Area of E-Box label
2	Area of D-Box label
3	Data of field system with serial and article number of E-Box and date of manufacture
4	Address of manufacturer
5	Warning notes
6	Temperature range and IP
7	Other information and reference to documentation
8	QR code
9	CE marking
10	Marking according to WEEE directive 2012/19/EU
11	Space for further markings

4.9.2.2 E-Box Label

Example view of an E-Box label

Label on E-Box	Label for E-Box on type plate
<p>ORCA01E0003000000 2022 36 50 0 E02A10000-00003N00000200-00000000000000Y</p> <p>Article-No. D-Box: 294338 Serial-No. D-Box: X47110815X</p> <p>Date: 02.23 Checked: 01.01.01 Name</p> <p>STAHL R. STAHL HMI Systems GmbH 50829 Cologne Made in Germany www.r-stahl.com</p>	<p>ORCA01EDMP0DC0000</p> <p>Article-No. E-Box: 356897 Serial-No. E-Box: X47110815X Date: 02.23</p> <p>Rated Voltage Range: xx-xx Vxx Rated Current: xx A Rated Frequency: xx-xx Hz</p> <p>9</p>

Explanation: see table "Key to E-Box and D-Box labels"

4.9.2.3 D-Box Label

Example view of a D-Box label:

Label on D-Box	Label for D-Box on type plate
<p>ORCA01E0003000000 2022 36 50 0 E02A10000-00003N00000200-00000000000000Y</p> <p>Article-No. D-Box: 294338 Serial-No. D-Box: X47110815X</p> <p>Date: 02.23 Checked: 01.01.01 Name</p> <p>STAHL R. STAHL HMI Systems GmbH 50829 Cologne Made in Germany www.r-stahl.com</p>	<p>ORCA01E0003000000</p> <p>Article-No. D-Box: 294338 Serial-No. D-Box: X47110815X Date: 02.23</p>

4.9.2.4 Key to E-Box and D-Box labels

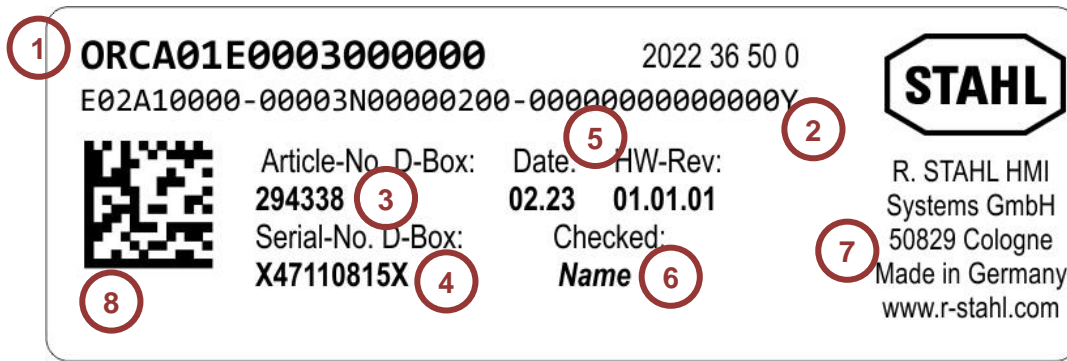

Item	Designation
1	Box family code
2	Box type key code
3	Box article number
4	Box serial number
5	Box manufacture date and hardware revision
6	Name of testing body
7	Address of manufacturer
8	QR code
9	Rated values on E-Box label on type plate

4.10 Ex marking

4.10.1 ATEX / IECEx

Ex marking ATEX / IECEx according to IEC 60079-0 and ATEX directive 2014/34/EU.

ORCA01E* HMI series

Version	2014/34/EU prefix	Ex marking
Gas	⊕ II 2(1) G	Ex eb ib qb [ib] [ia Ga] IIC T4 Gb
Dust	⊕ II 2(1) D	Ex tb [ib] [ia Da] IIIC T115°C Db

ORCA01M* HMI series

Version	2014/34/EU prefix	Ex marking
Gas	⊕ II 3(1) G	Ex ec ib qb [ib Gb] [ia Ga] IIC T4 Gc
Dust	⊕ II 3(1) D	Ex tc [ib Db] [ia Da] IIIC T115°C Dc

4.10.2 USA / Canada UL

ORCA01E* HMI series

Version	UL Zone Ex marking
Gas	Class I, Zone 1, AEx eb ib qb [ib] [ia Ga] IIC T4 Gb
Dust	Zone 21, AEx tb [ib] [ia Da] IIIC T115°C Db

Version	C-UL Zone Ex marking
Gas	Ex eb ib q [ib] [ia Ga] IIC T4 Gb X
Dust	Zone 21, Ex tb [ib] [ia Da] IIIC T115°C Db X

Version	UL and C-UL Division Ex marking
Gas	Class I, Division 2, Groups A, B, C, D T4
Dust	Class II, Division 2, Groups F, G T4 Class III, Division 2
	Enclosure Type 4X when mounted in suitable Type 4X enclosure.

ORCA01M* HMI series

Version	UL Zone Ex marking
Gas	Class I, Zone 2, AEx ec ib qb [ib Gb] [ia Ga] IIC T4 Gc
Dust	Zone 22, AEx tc [ib Db] [ia Da] IIIB T115°C Dc

Version	C-UL Zone Ex marking
Gas	Ex ec ib q [ib Gb] [ia Ga] IIC T4 Gc X
Dust	Zone 22, Ex tc [ib Db] [ia Da] IIIC T115°C Dc X

Version	UL and C-UL Division Ex marking
Gas	Class I, Division 2, Groups A, B, C, D T4
Dust	Class II, Division 2, Groups F, G T4 Class III, Division 2
	Enclosure Type 4X when mounted in suitable Type 4X enclosure.

4.10.3 PESO**ORCA01E* HMI series**

Version	Ex marking
Gas	Ex eb ib qb [ib] [ja Ga] IIC T4 Gb

4.10.4 CCC / CNEx

Chinese Ex marking CCC / CNEx according to GB/T 3836.1-2021, GB/T 3836.3-2021, GB/T 3836.4-2021, GB/T 3836.7-2021, GB/T 3836.31-2021.

ORCA01E* HMI series

Version	Ex marking
Gas	Ex eb ib qb [ib] [ja Ga] IIC T4 Gb
Dust	Ex tb [ib] [ja Da] IIIC T115°C Db

ORCA01M* HMI series

Version	Ex marking
Gas	Ex ec ib qb [ib] [ja Ga] IIC T4 Gc
Dust	Ex tc [ib] [ja Da] IIIC T115°C Dc

5 Operating systems and drivers

5.1 Windows 10 IoT Enterprise LTSC 2019 / 2021 operating system

The operating system is based on Windows 10 for PC platforms with 64 bit x86 processors. For the LTSC (Long-Time-Service-Channel) versions, Microsoft guarantees 10 years of security updates and new builds with feature updates only every 2-3 years, with these being optional. The LTSC versions are ideal for industrial applications and feature additional security components such as write filters (UWF) and HORM (start of a system snapshot from the RAM plus write protection).



* The HORM function is currently not supported in Windows 10 IoT Enterprise LTSC 2021 !

From 2016 LTSB onwards, Microsoft has tied its licensing model to the processor performance:

ENTRY for AMD® GX and ATOM™
VALUE for Intel® Core i5™
HIGH for Intel® Core i7™

The license for the Windows 10 IoT Enterprise LTSC 2019 / 2021 operating system is included in the image. When delivered, the devices have already been registered and activated.

The EOL (End of Life) date for Windows 10 IoT Enterprise LTSC 2019 for support and updates has been set by Microsoft to 09.01.2029 and for Windows 10 IoT Enterprise LTSC 2021 to 13.01.2032.

5.1.1 Recovery



If a Panel PC is reset to the factory state (recovered) it will remain registered and will have to be reactivated.
This requires an active internet connection to a Microsoft server.

5.1.2 Proprietary Windows installations and drivers



The Windows 10 IoT license key is tied to STAHL images. The installation of own Windows 10 operating systems requires a separate license key. All necessary drivers are provided by R. STAHL HMI Systems GmbH. Please contact our Support department.

5.2 Data back-up

5.2.1 Recovery Stick



A recovery stick is required to restore the Panel PC devices to their factory state. This recovery stick (USB-drive, also available as an intrinsically safe version) contains the factory image, with which the system can be restored to delivery status within a very short time.

You can restore the HMI devices to their factory state only with the aid of this recovery stick. As an option, the recovery stick can also contain a backup software, with which you can back up your own device configuration.

5.2.2 Back-up

It is the sole responsibility of the operator to generate a back-up of the HMI devices and their overall function.

- Any back-ups generated of the HMI devices must always be stored on external storage media.

5.2.3 Switching off / closing down



The Microsoft Windows operating system stores key data in the main memory, regardless of the application, and has to store this data on the hard disk before the HMI device is switched off.

It is therefore important for the safe and correct operation that the HMI device is "shut down" properly and not simply switched off.

Otherwise the existing image of the HMI device may be damaged, rendering the device non-functioning. After the data has been stored, Windows informs the user that the HMI device can now be switched off.

5.2.4 Loss of data

- In the case of applications that require constant writing into memory, R. STAHL HMI Systems GmbH recommends you use external storage media (USB sticks, network servers) for these write processes.
- Avoid cyclical writes (log files, databases, etc.) to the SSD.

The endurance of an SSD depends on the number of write cycles (TBW / terabytes written). Writing to the SSD with a simultaneous drop in voltage is most likely going to result in data loss.

5.3 License sticker

The license sticker for the Windows 10 IoT Enterprise LTSC operating system is located on the side of the E-Box.

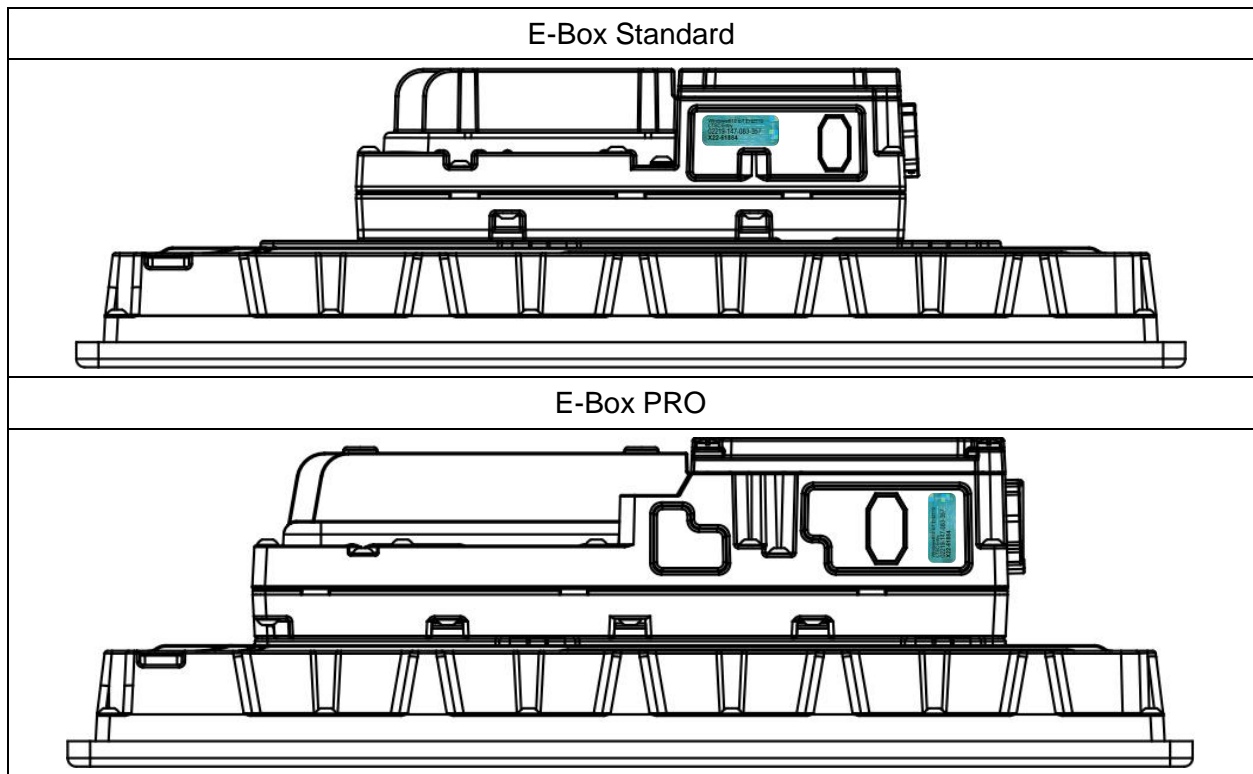

5.4 UPDD touch driver

The UPDD touch driver is a copyrighted, licensed software for the exclusive use with R. STAHL HMI Systems GmbH touch systems.

- Do not load this driver on or use with other devices.

6 Transport and storage

NOTE	<p>Missing or damaged packaging during transport and storage</p> <p>If the device is transported or stored without packaging, shocks, vibrations, pressure and humidity can directly impact the device. Damaged packaging indicates that the device has been subjected to and possibly been damaged by outside influences. This may result in faulty functionality.</p> <ul style="list-style-type: none">• Check the state of the packaging.• Report any damage sustained in transport to the haulier responsible and have it confirmed.• Transport and store the device in undamaged packaging, ideally the original packaging.
-------------	--

- Transport and store the device carefully and in accordance with the safety notes (see chapter [3 Safety](#)).
- Transport and store the device in undamaged packaging, ideally the original packaging.
- Ensure specified storage temperature range is not exceeded (see chapter [17.1.4 Ambient conditions](#)).
- Store the device in a dry place free of vibrations.
- Do not drop the device.

7 Unpacking

- Unpack the device at its final destination.
- Check against the delivery note that the contents are complete and undamaged.
- Contact the manufacturer if the contents are incomplete, damaged or not what you have ordered.
- Dispose of the packaging materials according to local regulations.

8 Mounting and installation

8.1 Note on mounting and installation

Observing the following points will ensure a professional and safe assembly and installation

- Only use threads or holes already present in the enclosure.
- Mount the device carefully and strictly in accordance with the safety notes (see chapter [3 Safety](#)).
- Study the installation conditions and assembly instructions in these operating instructions carefully and follow them to the letter.
- Completely close the ORCA-OFR enclosure (to the second stop) to ensure IP tightness (seal) !
- The devices may only be installed and operated in an undamaged, dry and clean condition ! Any damage may compromise the explosion protection !
- National assembly and installation rules and the generally accepted rules of technology must be observed. The device and its accessories must be installed and operated according to applicable standards, directives and installation guidelines.
- Only use suitable tools for the installation.
- Do not open the connection box when live.
- Disconnect the device from supply before separating E-Box and D-Box for servicing.
- Tightening torque for connection box screws: 3.5 to 3.7 Nm. Tightening torque for mounting of E-Box and D-Box (for servicing): 3.5 to 3.7 Nm.
- The devices are delivered with screw plugs. Before installation, mount the required cable glands on the device.
- The PA / earth connection of the DC device variants is internally connected to terminals X1-3 and X1-4 of the power supply connection.
- A sun roof is recommended to protect the HMI in environments where the display is exposed to direct sunlight. This is available for the 22" displays and enclosure versions FR and CFR, but does not increase the usable upper temperature range !

8.1.1 Note on mounting and installation according to NEC / CE-Code / UL

- Installation according to Control Drawing 10608602.
- Appropriate wiring device and method per NEC / CE-Code and must meet IP65 rating or better.
- Ambient rating $-20\text{ °C} \leq T_a \leq +55\text{ °C}$ (for Panel-mount device, at OFR $+50\text{ °C}$) at place of installation. Relative humidity 90% at 40 °C non-condensing. Altitude up to 2,000 m. Outdoor use.
- This associated apparatus may also be connected to simple apparatus as defined in the National Electrical Code (ANSI/NFPA 70), or other local codes, as applicable.
- Intrinsically safe circuits must be wired and separated in accordance with Article 504.20 of the National Electrical Code (ANSI/NFPA 70) or other local codes, as applicable.

- Cable glands for use with non-armored cables. Cable glands used must be suitable and certified for the area of installation and adjusted if necessary. Not used cable glands must be closed with suitable blind plugs. When installed with cable, this device shall be installed in areas where the cables has been deemed suitable for the locals as defined in the NEC® / CE-Code.
- For USA: All circuits must be wired using the National Electric Code NFPA 70 or other local codes for installation within the United States.
- For Canada: All circuits must be wired as specified in the Canadian Electric Code or other local codes for installation within Canada.
- For ORCA "AC" models:
Overvoltage category II according to IEC 60664-1
A disconnecting device, such as a switch or circuit breaker, must be included in the installation. It must be located in an appropriate and easily accessible place and must be marked as the disconnecting device for the equipment. Additionally, it shall disconnect all current-carrying conductors and must not interrupt a protective earth conductor

Environmental conditions for installation regarding NEC® / CE-Code:

- Indoor use dry location or outdoor use when mounted on type 3X or better enclosure.
- Pollution Degree 2 according to IEC 60664-1 or mounted on type 3X or better enclosure.

8.2 Requirements for site of installation



Mount and install the device in such a way that it is always operated within the permissible temperature range.

- Observe the stipulated hazardous zones: ORCA01M* devices may only be installed in Zone 2 and Zone 22.
- The site of installation must be stable and suitable for the dimensions of the device, and able to bear the load of its weight and that of any necessary attachments.
- Ambient temperature: $-20\text{ °C} \leq T_a \leq +55\text{ °C}$ (for Panel-mount device, at OFR $+50\text{ °C}$) at place of installation. Relative humidity 90 % at $+40\text{ °C}$, non-condensing. Outdoor installation permitted up to a height of 2,000 m. IP65 according to IEC 60079-0. The device may be installed and operated in any position.
- Electric parameters of a maximum of 250 V / 17 A must be guaranteed at the place of location.
- In the case of AC models: install an easily accessible disconnection mechanism outside of the device, which can be used to interrupt all conducting wires but not the protective conductor.
- Avoid touch screen contamination by saltwater: conductive liquids on the touch display can result in incorrect or phantom operations. This applies in particular to salt water.
- Protect the device against rain, snow and splashes: excessive amounts of standing or running water will disrupt operation and may cause erratic cursor movement. This protection can be achieved by using a canopy or some other protective roof-type construction. Offshore, strong winds, saltwater and rain will have to also be taken into consideration.

8.3 Mounting types

The device may be installed and operated in any position. R. STAHL recommends the following types of mounting:

Panel mount, wall mounting, mounting on stand / elbow.

8.4 Front installation

The ORCA device platform Panel-mount devices can be mounted inside an enclosure with suitable cut-out with the aid of a fixing frame. This type of mounting is approved for installation in Ex e, Ex p or Ex tb enclosures.

A 20 mbar excess pressure was tested for Ex p applications.

The fixing frame is used to fix the device inside the cover cut-out of the enclosure. It is mounted from the back.

Tightening torque	
Fixing frame screws	3.5 to 3.7 Nm

8.4.1 Panel-mount – installation

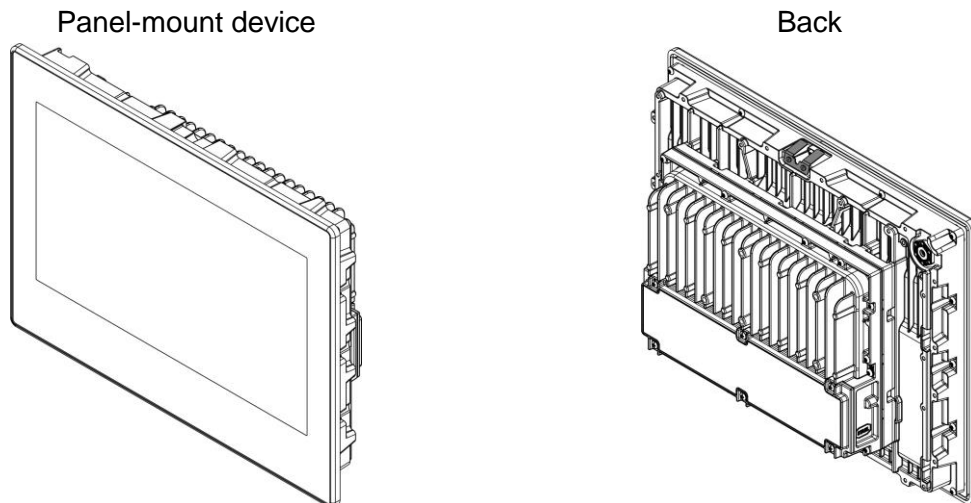

 The devices are delivered with screw plugs. Before installation, mount the required cable glands on the device.

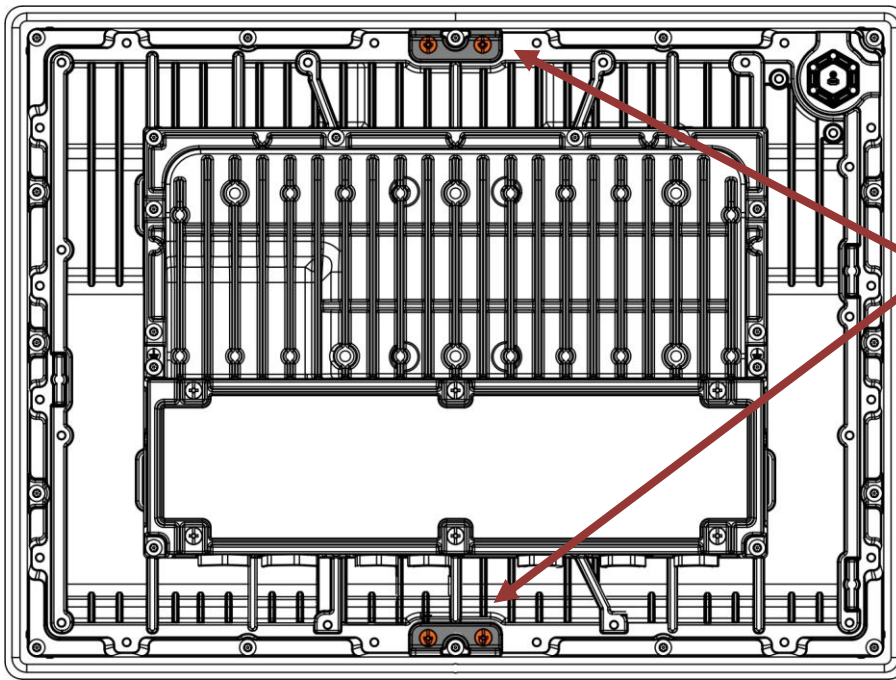

- (quick-) installation clip (top and bottom)
- screws are tightened

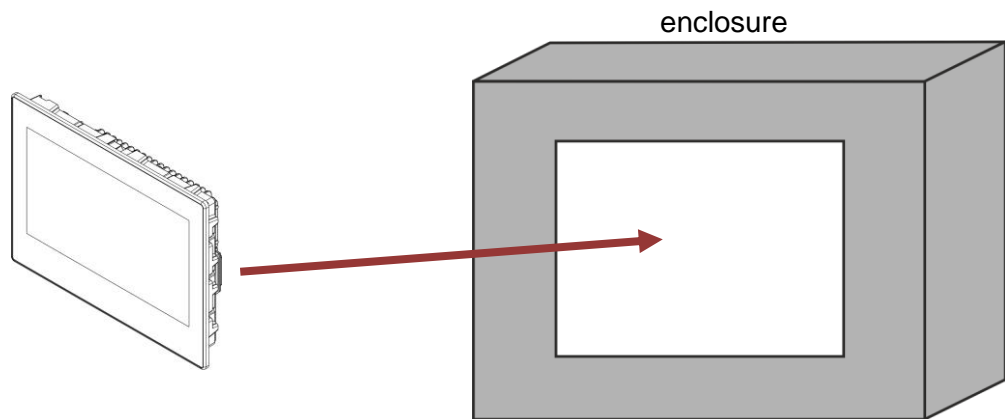

For dimensions of mounting cut-out of enclosure, see chapter [4.5.1.3 cutout](#)

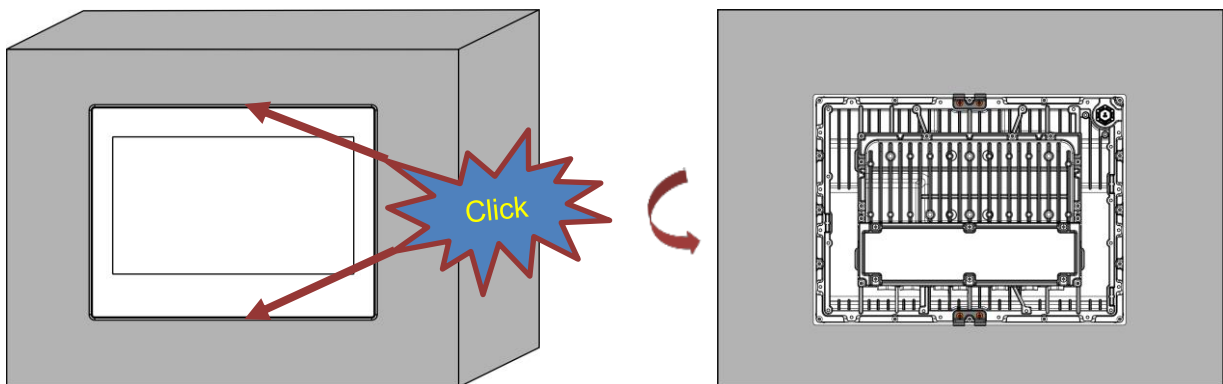

- Assembly of mounting frame
 - consisting of 2 identical L-shaped frame parts
 - all M4 screws (Torx TX20) pre-mounted and secured with captive washers (x2A and x4A frame with 16 screws, x9A frame with 26 screws)

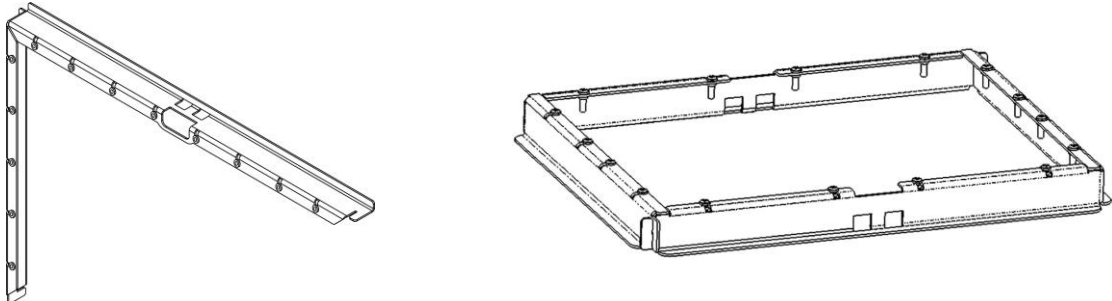

- Slide the fixing frame over the back of the device

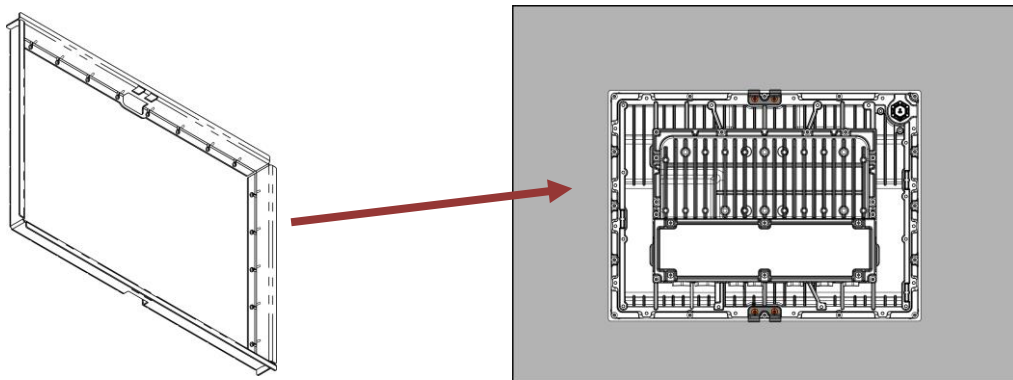

- Tighten all fixing frame screws with 3.5 to 3.7 Nm.
- Observe the order in which screws should be tightened (x4A and x9A frames accordingly)

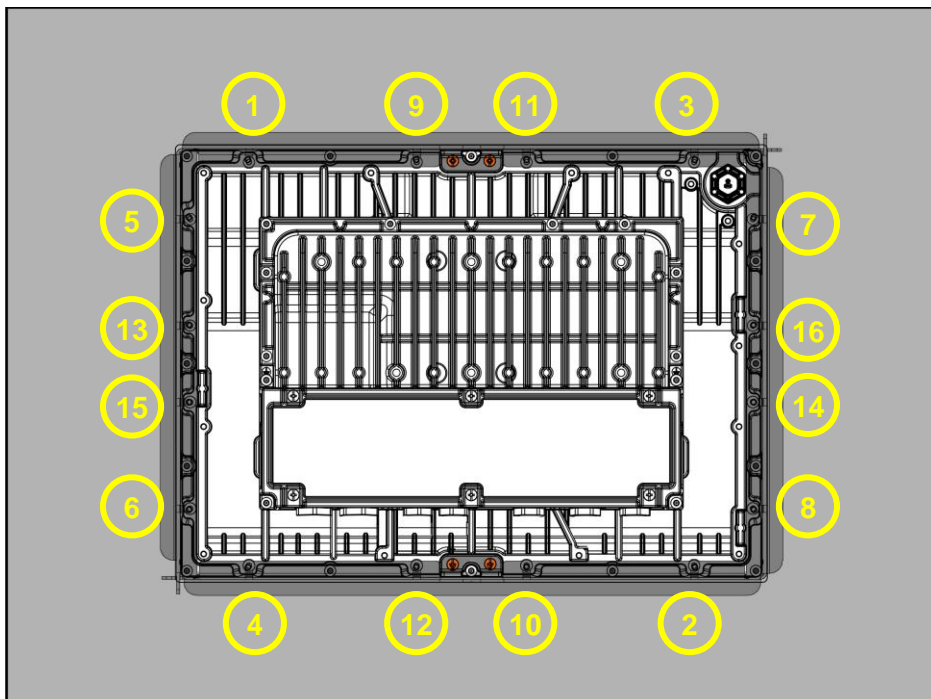

8.5 Mounting instruction card holder

 Additional information see Operating Instructions UB03-* (OI_UB03).

 DANGER	<p>Explosion hazard due to electrostatic charge ! Non-compliance may result in fatal or serious injuries.</p> <ul style="list-style-type: none"> Do not remove the protective film from the visible surface during assembly ! No scratches allowed on the visible surface !
---	---

- Clean mounting surface
- Remove the protective paper from the adhesive tape (on the back side of the card holder)
- Glue the card holder at the recommended mounting position
- Wait 24 hours before use (adhesive strength increases)
- Observe the conditions of the conformity assessment (see [Conformity assessment card holder](#)) !

8.5.1 Recommended mounting position

8.5.1.1 For ORCA01* operating device 22"

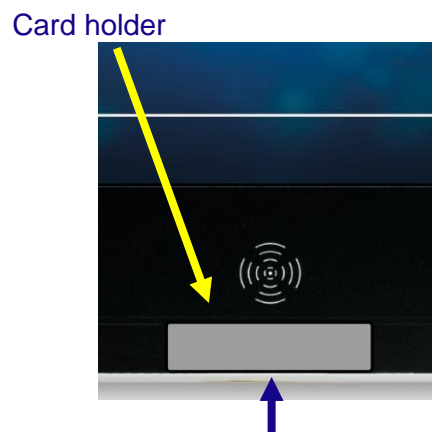

- Card holder aligned with bottom edge
- centered below the card reader symbol

8.5.1.2 For UB03-*RFID

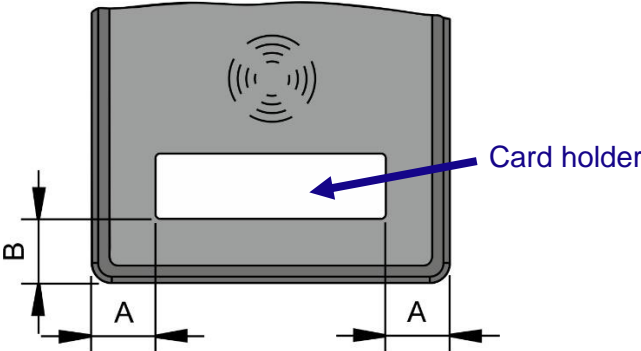

A	B
25.5	25

8.6 Installation



Explosion hazard due to improper installation !

Non-compliance may result in fatal or serious injuries.

- Ensure the atmosphere is non-explosive.
- Make sure that the device is not damaged.
- If the device is connected to the mains:
 - Disconnect the device from the power supply.
 - Isolate all circuits and wait 20 minutes before opening the connection box !



Explosion hazard due to electrostatic charge !

Non-compliance may result in fatal or serious injuries.

- Do not apply protective foil to the touch display.



Danger of laser radiation at emitting diode (TD-A, TD-B) or at the end of the fibre optic cable.

Eye injury

The laser diodes in the operating devices, media converters and switches emit invisible laser radiation:

100Base-FX	- 1300 nm
FO-MM / 1000Base-SX	- 770 ... 860 nm
FO-SM / 1000Base-LX	- 1270 ... 1355 nm

According to EN 60825-1, the laser diode is assigned to the laser class 1.

- Do not view the laser radiation directly (within a distance of 100 mm) with optical instruments (e.g. magnifiers, microscopes).

8.6.1 General information on electric connection

- Connect cables carefully.
- Do not screw down on the cable insulation.
- Do not switch cables.
- Observe code of practice when connecting cables.
- Firmly screw down wires.
- Pay attention to the voltage specified on the device:
 - Connect DC devices to 24 VDC only.
 - Connect AC devices to 85 to 250 VAC only.
 - The PA / earth connection of the DC device variants is internally connected to terminals X1-3 and X1-4 of the power supply connection.
- Pay attention to specified torques for screws to avoid damage to threads.
- Suitable measures against electrical surge during lightning strike may be necessary.
- Ensure cable shields are firmly secured on all sides. We recommend using suitable cable clips or EMC connections.

8.6.2 Connecting device to power supply

1. Open the cover of the connection box (see chapter [4.4 Connection box](#)).
2. Connect cable to X1 POWER terminal (see chapter [19.1 Connection overview terminal assignment](#)). Ensure correct polarity and power supply (AC or DC).

8.6.3 Grounding the device

- Ground the devices with a core cross section of at least 4 mm² or in line with applicable standards, or connect to the equipotential bonding conductor of the hazardous area.
- Preferably use earth connection at the side closest to the power supply terminals.

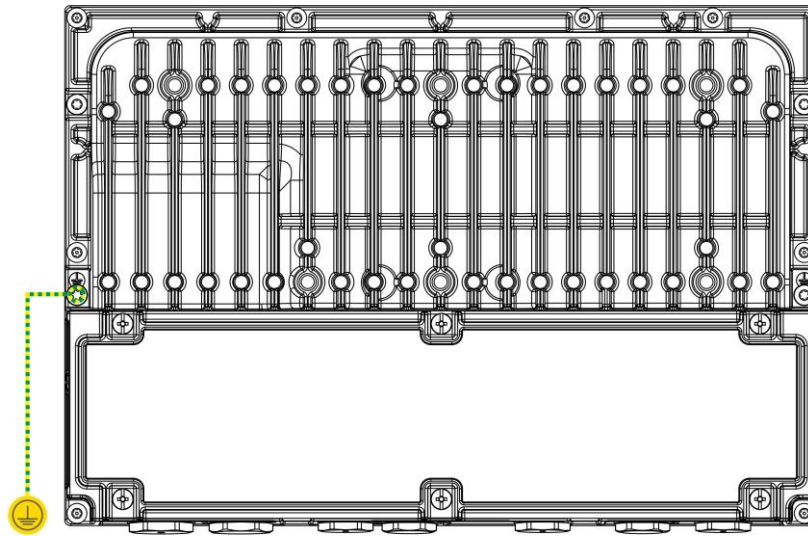

- Tighten earth connection screws with a torque of 3.5 to 3.7 Nm.

	Fastening material for the earth connection is located at the device.
	The PA / earth connection of the DC device variants is internally connected to terminals X1-3 and X1-4 of the power supply connection.

8.6.4 Connecting data cable

- Connect the data cables according to the terminal diagram (for copper connections) or connect them to the sockets (for FO connections).

8.6.5 Mounting the cover of the connection box

Tightening torque	
connection box cover screws	3.5 Nm to 3.7 Nm

8.6.6 Connecting associated equipment

The connection box includes mounting options for associated equipment such as cable glands, cable connectors, buttons.

Cable glands or other accessories used in the threads of the connection box must be suitable and certified for the area of installation and might have to be adapted. The applicable Ex requirements and IP65 according to Ex requirements or above must be met. Potential changes to the ambient parameters such as temperature must be taken into account.

- Observe the specific requirements of the associated equipment used (e.g. permitted cable diameter for cable glands, tightening torques, cable clamps).
- Observe country-specific regulations, in particular any ambient parameters that may be different (e.g. ambient temperature range).
- Attach an easily accessible disconnection mechanism to interrupt the power supply on the outside of the device.
- Close unused openings with a blind plug.
- Cable glands with parallel threads must have the following characteristics:
 - Tolerance class 6H or higher
 - additional seal

8.6.7 Cable glands

In their factory state, the devices are equipped with cable glands or screw plugs. They have been chosen to comply with all relevant certifications of the device. The device's ex-relevant markings also cover the bushings, which are not necessarily separately marked when included in the delivery.

- Seal unused cable glands with certified screw plugs.
- Close any open enclosure holes without cable glands with a certified screw plug. Such certified screw plugs must be approved for the following areas or higher:
 - Certified zone
 - Permitted temperature range
 - Country approval (e.g. ATEX for Europe) of the device
- Alternative, similar and certified cable glands may be used provided they have an equal or higher area of certification (zone) and permitted temperature range, and the same country approval (e.g. ATEX for Europe) as the HMI device.
- Use cable glands with cap nut and without strain relief clamp for permanently installed cables and electrical lines only.
- Install the device in such a way that there is no mechanical impact (tensile force) on the cables. Fix the cable and effectively protect against damage.
- Observe recommended tightening torques. Too low or too high tightening torques might have a negative impact on the type of protection, sealing or strain relief.
- Before commissioning, check any screws that are already mounted and tighten them if necessary.
- Pre-mounted cable glands are designed for non-armoured cables.

- Thread sizes
 E-Box PRO: 1x M25x1.5; 3x M20x1.5; 7x M16x1.5
 E-Box Standard: 2x M20x1.5; 5x M16x1.5
 Optional, pre-mounted cable glands suitable for cable diameters ranging from
 M25 = 14...18 mm, M20 = 6...12 mm, M16 = 4...8 mm.
- Cable glands
 M25 = 14...18mm (Hummel AG part no.: 1.640.2500.50)
 M20 = 6...12 mm (Hummel AG part no.: 1.640.2000.50)
 M16 = 5...10mm (for keyboard KB2) (Hummel AG part no.: 1.640.1611.50)
 M16 = 4...8mm (Hummel AG part no.: 1.610.1600.30)
- Screw plugs for devices without NEC / CEC certification:
 M25 (Hummel AG part no.: 1.640.2500.50)
 M20 (Hummel AG part no.: 1.640.2000.50)
 M16 (Hummel AG part no.: 1.640.1611.50)
- Screw plugs for devices with NEC / CEC certification:
 M25 (CMP part no.: 767DRM35)
 M20 (CMP part no.: 767DRM25)
 M16 (CMP part no.: 767DRM15)

 The documentation from the manufacturer for the cable glands and screw plugs must be taken into account.

Tightening torque	
Cable glands	Depending on cables used: <ul style="list-style-type: none"> • Individually determine and apply required tightening torques.
Cable glands (installed ex-factory)	In the case of factory-supplied systems, all components are installed correctly and in accordance with applicable standards.

8.6.8 Electric connections of interfaces X1, X2, X3, X4, X5, X6, X7, X9, X10, X11, X12 and X13

Stripping length	9	mm
Mounting torque	0.5 ... 0.6	Nm

Connectable conductor cross section		
• Rigid	0.2 ... 2.5 (24 ... 14)	mm ² (AWG)
• flexible	0.2 ... 2.5 (24 ... 14)	mm ² (AWG)
Multi-conductor connection (flexible with core end sleeve with or without plastic sleeve) (two conductors with the same cross section and conductor type)		
• rigid	0.2 ... 0.75 (24 ... 18)	mm ² (AWG)
• flexible	0.25 ... 1.5 (24 ... 16)	mm ² (AWG)

Notes on screw connectors:

- Ensure that the following maximum rated current values are not exceeded:
 - The maximum rated current value for every contact of the X1 screw connector is 17 A.

- Values that must not be exceeded at the place of installation:
 - Voltage: max. 250 V
 - Short-circuit current: max. 1500 A
- Only use copper wires and cable glands with the following characteristics for connections to the device:
 - For $-20\text{ °C} < T_a \leq +30\text{ °C}$: copper wires / cable glands approved for at least 70 °C
 - For $+30\text{ °C} < T_a \leq +55\text{ °C}$: copper wires / cable glands approved for at least 95 °C

 Observe and apply tightening torques recommended for connection terminals.

8.7 Using USB interfaces

Hardware and connection					
Connection to	intrinsically safe USB devices			non-intrinsically safe equipment	
	safe area	Hazardous areas	Device	safe area	Hazardous areas
X5 (Ex i)	x	x	e.g. KB2-*-HSG-*- keyboard cable	–	–
X6 (Ex i)	x	x	e.g. KB2-*-HSG-*- pointing device - cable	–	–
X7 / X8 (Ex i)	x	x	e.g. USBi Drive	–	–
X3 (Ex e)	–			any USB device	explosion-protected but non-intrinsically safe devices
at E-Box PRO X11 (Ex e)	-			only for "bus powered / passive devices"	
				any USB device	explosion-protected but non-intrinsically safe devices
at E-Box PRO X12, X13 (Ex e)	-			only if module is equipped only for "bus powered / passive devices"	
				any USB device	explosion-protected but non-intrinsically safe devices

 See also notes on interfaces in chapter [19.1. Connection overview terminal assignment](#).

9 Initial start-up

Conditions:

The device has been installed correctly.

The device has been connected to the equipotential bonding.

1. Since factors such as storage or temperature can have an impact on the cables and cable glands, check the following connections:
 - Connection terminals
 - Existing screw connections
2. Switch on power supply.
 - The device will start up in its standard configuration.
3. Follow the instructions on the screen.



10 (Re-) Commissioning

1. Check the device is correctly installed:
 - Connection terminals
 - Existing screw connections
2. Check the device for visible damage.
 - Only commission the device if there is no visible damage and if it has been correctly installed.
3. Switch on power supply.
 - The device will start up with the configuration saved last.
 - If the connected systems can be reached, communication will be established within the existing parameters.

11 Operation

 DANGER	<p>Explosion hazard due to damaged device ! Non-compliance may result in fatal or serious injuries. In case of damage or changes to the factory state (for example if the device is leaking small glass beads):</p> <ul style="list-style-type: none"> • Decommission device immediately. • Contact manufacturer.
---	--

 DANGER	<p>Explosion hazard due to electrostatic charge ! Non-compliance may result in fatal or serious injuries.</p> <ul style="list-style-type: none"> • Do not apply protective foil to the touch display.
---	---

 WARNING 	<p>Hot surfaces ! Non-compliance may result in minor burns. In ambient temperatures exceeding +45 °C the surface of the device may heat up.</p> <ul style="list-style-type: none"> • Do not touch the device.
---	---

NOTE	<p>Display damage due to permanent display of identical pattern Non-compliance will result in screen burn-in.</p> <ul style="list-style-type: none"> • Use screen savers or regularly move the screen pointer if a specific pattern is displayed permanently.
------	---

11.1 Operating the touch display

NOTE	<p>Touching the touch screen with pointed or sharp items Non-compliance may result in damage to the touch display, shorter life-span or total breakdown !</p> <ul style="list-style-type: none"> • Only operate the touchscreen with your finger or thin / special gloves.
------	--

NOTE	<p>Preventing malfunction and functional impairment Non-compliance will result in malfunction and functional impairment of the touch display !</p> <ul style="list-style-type: none"> • Device must be integrated into the facility's functional earth. • The functional earth is used to suppress electromagnetic disturbance.
------	--

Incorrect operation of the touch display may result in accidental functions and errors. The device will then be unable to execute orders, may execute them incorrectly or in a way not intended.

- Do not realise safety-relevant functions via the touch display.
- Avoid accidental multiple touches.
- Do not touch the touch display across a large section.
- Only use fingers, thin gloves or special gloves for operation.
- Before operating the device, thoroughly acquaint yourself with the multi-touch functions of the operating system and the application.
- Avoid contamination of the touch display with salt water.

11.2 Switching the device on and off

11.2.1 Without optional on/off button

The device is switched on and off via the power supply.

R. STAHL recommend you switch off the ORCA platform devices via the respective Windows / Remote Image function.

11.2.2 With optional on/off button

The device is switched on and off with an optionally available on/off button. The button function is defined via the operating system and functions like power button of a notebook.

R. STAHL recommend you switch off the ORCA platform devices via the respective Windows / Remote Image function.

11.3 Teaming function





Teaming function					
E-Box	Standard	PRO			
		Interface			
Processor	1TX	2TX	1TX + 1FX	1TX + 2SX	1TX + 2LX
ATOM	no	yes	yes	yes	yes
Intel Core i5	-	yes	yes	yes	yes

- Providing redundancy due to automatic switch to a different network adaptor.
- Using the Ethernet adaptors in the team as standby adaptors, realising redundancy, making the system more fail-safe.
- Bundle the speed of the Ethernet adaptors in order to increase performance.



For a description of the function and its settings refer to the Remote HMI V6 software manual (industrial-grade Thin Client firmware).

12 Maintenance, overhaul and repair

 DANGER	<p>Explosion hazard due to damaged seal or leaking of filling material ! Non-compliance may result in fatal or serious injuries !</p> <ul style="list-style-type: none"> • In case of damage or changes to the factory state immediately decommission the device. <ul style="list-style-type: none"> ○ If the device leaks filling material (small glass beads) it must be decommissioned immediately. • Contact manufacturer.
 DANGER	<p>Explosion hazard due to incorrect maintenance or repair ! Non-compliance may result in fatal or serious injuries !</p> <ul style="list-style-type: none"> • Ensure the atmosphere is non-explosive. • Make sure that the device is not damaged. • Do not open the enclosure. • If the device is connected to the mains: <ul style="list-style-type: none"> ○ Disconnect the device from the power supply. ○ Isolate supply and all circuits and wait 20 minutes before opening the terminal boxes.
 WARNING 	<p>Hot surfaces ! Non-compliance may result in minor burns ! In ambient temperatures exceeding +45 °C the surface of the device may heat up.</p> <ul style="list-style-type: none"> • Do not touch the device.

Additional for ORCA01M* HMIs:

Do not open, service or repair in an area where an explosive atmosphere may be present.

12.1 Changing the battery

The internal battery may only be replaced by the manufacturer.

12.2 Servicing

The enclosure is sealed and cannot be opened.

When servicing the device, check the following points in addition to those stipulated in the national regulations:

- Damage to seals: cracks or other visible damage to the device enclosure / front glass and / or the protective enclosure.
- All cables and conductors securely connected: cables tightly clamped
- All cables and conductors undamaged
- Compliance with permitted temperature range
- Mounting fits securely, all screws tightened fast
- Ensure the device is used as intended

12.3 Maintenance

The devices are maintenance-free across their entire lifespan.

- Focus on the following during system maintenance:
 - Seal wear, front screen / glass damage
 - screws properly tightened
 - all cables and conductors correctly connected and undamaged

12.4 Repair

The display and E-Box modules cannot be repaired by the customer.

- Any repair on the device is to be performed by R. STAHL only.
- The modules may be sent back separately.
- The modules must be dismantled by qualified staff only (see chapter [3.3 Personnel qualification](#)).

12.4.1 Mounting / dismantling the modules

The ORCA series HMIs consist of a display box module and an E-Box module which are mounted together. These modules can be replaced for repair purposes.

Dismounting modules:

- Disconnect all circuits from the power supply and wait for 20 minutes.
- Remove the connection box cover.
- Disconnect cables and external earthing.
- Unscrew the E-Box screws (see markings).

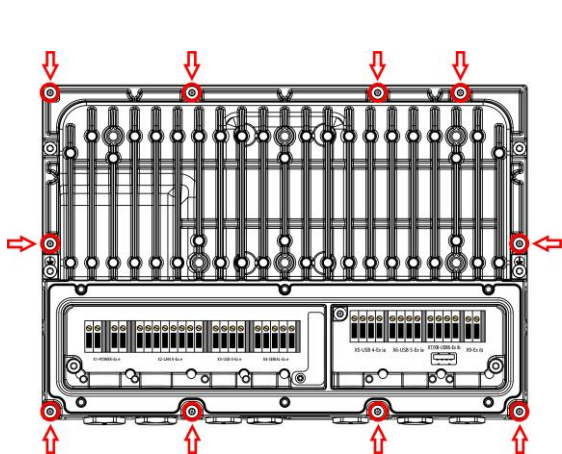

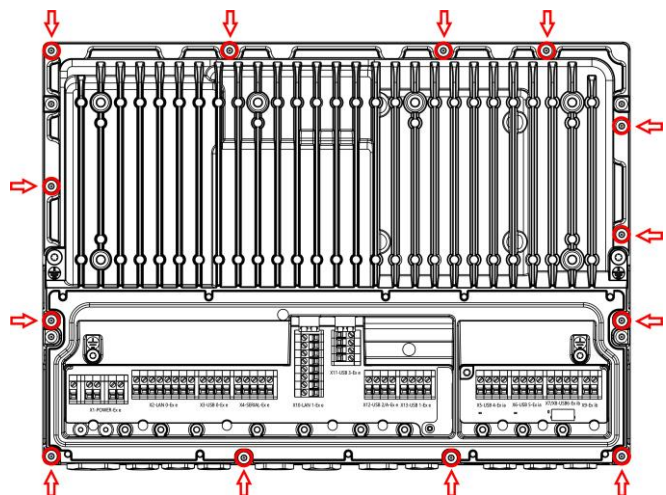

Rear view E-Box Standard



Rear view E-Box PRO

- Lift the E-Box vertically and evenly.
- Do not damage seal.
- Protect plug connector board.

 DANGER	<p>Explosion hazard due to damaged seal ! Non-compliance may result in fatal or serious injuries.</p> <ul style="list-style-type: none"> • Ensure the atmosphere is non-explosive. • Ensure seal is undamaged. • Ensure seal is correctly positioned. • Replace damaged seal immediately.
---	--

NOTE 	<p>Possible mechanical or electric damage to the plug connector board. If the plug connector board is not protected with a cover and suitable ESD measures it may be damaged and the modules' function may be impaired. The plug connector board is a device interface which has been constructed to contain limited ESD protective measures and which can be serviced by trained personnel. To prevent any damage to the components, suitable mechanical and ESD protective measures must be taken.</p> <ul style="list-style-type: none"> • Carry out ESD protective measures before dismounting. • Once dismantled, protect plug connector board.
--	---

Mounting modules:

The steps for mounting the modules are those described in "Dismounting modules" in reverse.

- After removal and installation of the module, the device must correspond to the delivery condition again.
- The chapter on residual risks must be observed. In case of non-observance the explosion protection can be cancelled.
- Where applicable, re-install plug connector board.
- Seal positioned correctly and undamaged.
- Position the E-Box with its 3 lateral fins vertically and in parallel in the corresponding recesses of the D-Box.
- Grease screw connections between E-Box and D-Box.
- Tighten by hand one screw on the right-hand side and one on the left-hand side of the E-Box.
- Insert and tighten all remaining screws crosswise and with the correct torque.

Tightening torque	
Screws connecting the display and the E-Box	3.5 to 3.7 Nm

- Connect cables and external earthing.
- Close connection box cover.
- Operate device.

13 Returning the device

Only return or package the devices after consulting R. STAHL. Contact the responsible representative from R. STAHL. R. STAHL's customer service is available to handle returns if repair or service is required.

Contact customer service via E-mail or telephone:

- E: service.dehm@r-stahl.com
- T: +49 221 76806 3000

Requesting a RMA ticket via our website:

- Go to r-stahl.com.
- Under "Support" > "RMA" > select "RMA-REQUEST".
- Fill out the form and send it in.
- You will automatically receive an E-mail with an RMA ticket.
- Print out the RMA ticket.
- Clearly copy the RMA number onto the outside of the package.
- Send the device with the RMA ticket included in the package to R. STAHL HMI Systems GmbH (see chapter [1.1 Manufacturer](#) for the address).

14 Cleaning

- Check the device for damage before and after cleaning it. Decommission damaged devices immediately.
- Devices located in hazardous areas may only be cleaned with a damp cloth to avoid electrostatic charge.
- When cleaning with a damp cloth, use water or mild, non-abrasive, non-scratching cleaning agents.
- Do not use abrasive cleaning agents or solvents.
- Never clean the device with a strong water jet, such as a pressure washer.

15 Disposal

- Observe national, local and statutory regulations regarding disposal.
- Separate materials for recycling.
- Ensure environmentally friendly disposal of all components according to statutory regulations.

16 Accessories

NOTE	<p>Malfunction or damage to the device due to the use of non-original components.</p> <p>Non-compliance may result in material damage.</p> <ul style="list-style-type: none">• Only use original accessories by the manufacturer.
-------------	--

17 Appendix A

17.1 Technical data E/M5xA

17.1.1 General

Function / Equipment	PM E52A PM M52A	PM E54A PM M54A	PM E59A PM M59A	OS E59A OS M59A
Technology	Panel PCs / Thin Clients			
E-Box	Standard	Standard or PRO		
HMI-type	Panel-mount device			Operator Station
Enclosure type	-			ORCA OS enclosure OFR

17.1.2 Electrical data

Function / Equipment	E52A M52A	E54A M54A	E59A M59A
Power supply	24 VDC	24 VDC or 230 VAC	
AC rated operational voltage	-	230 V	
Voltage range AC	-	100 V - 240 V (+4.1 % / -15 %)	
DC rated operational voltage	24 V	24 V	
Voltage range DC	24 V (+30 % / -20 %)	24 V (+30 % / -20 %)	
Power consumption AC	-	1 A	
Current consumption DC	3 A	3 A	
Frequency range	-	47 – 63 Hz	
Rated operational power	27 – 60 W	27 – 60 W	
internal fuses AC	-	2 A	
internal fuses DC	4 A	6.3 A	
Terminal box	Power supply direct in integrated connection box (separate Ex e and Ex i compartments)		
Connections	via screw terminals, green		
Conductor type	Flexible conductors 0.2 to 2.5 mm ² (AWG24 to AWG12) rigid conductors 0.2 to 2.5 mm ² (AWG24 to AWG12) (details see chapter 8.5.8 Electric connections of interfaces X1, X2, X3, X4, X5, X6, X7, X9, X10, X11, X12 and X13)		
max. operating voltage Um	250 VAC		
Processor type	Intel® ATOM™ E3940	Intel® ATOM™ E3940 Intel® Core i5™ 8365UE	
Processor details	1.6 / 1.8 GHz Quad Core	ATOM: 1.6/ 1.8 GHz, Quad Core i5: 1.6 / 4.1 GHz, Quad Core	
Graphics controller	Intel® HD-Graphics 500	ATOM: Intel® HD-Graphics 500 i5: Intel® UHD-Graphics 620	
Main memory	4 GB / 8 GB	ATOM: 4 GB / 8 GB i5: 16 GB	
Data memory	64 GB - 256 GB		
Operating system	none none / PXE Boot Windows 10 IoT Enterprise LTSC 2019 / Windows 10 IoT Enterprise LTSC 2021 IGEL OS		
Note on operating system	IGEL OS: pre-installed without licence		
Image	Windows 10 IoT Enterprise LTSC 2019 64- bit Windows 10 IoT Enterprise LTSC 2019 64- bit Remote HMI Firmware V6 Windows 10 IoT Enterprise LTSC 2019 64- bit Movicon 11 Windows 10 IoT Enterprise LTSC 2021 64- Bit Remote HMI Firmware V7 IGEL OS		

Ethernet note	TX	Optionally:	
		E-Box Standard with 1TX	-
		E-Box PRO with 2TX or 1TX and 1FX or 1TX and 2SX or 1TX and 2LX	
Ethernet / Data	10/100/1000BaseTX	E-Box Standard 10/100/1000BaseTX	-
		E-Box Pro: 2 x 10/100/1000BaseTX, 1x 10/100/1000BaseTX + 1 x 100BaseFX, 1x 10/100/1000BaseTX + 2 x 1000BaseSX, 1x 10/100/1000BaseTX + 2 x 1000BaseLX	
Data cable	CAT5 / 7 AWG23	TX: CAT5 / 7 AWG23 FX / SX: FO cable 50/125 µm or 62.5/125 µm LX: FO cable 9/125 µm	
Length of data cable	100 m	TX: 100 m FX / SX 50 µm: 500 m FX / SX 62.5 µm: 300 m LX: 10 km	
Interface medium	CAT5 / 7 data transmission	TX: CAT5 / 7 data transmission FX / SX: Multi-mode optical cable LX: Single mode optical cable	
Note on data cable	Ex e Screw terminals	TX: Ex e Screw terminals	
Plug version FO	-	LC duplex socket	
USB interface	E-Box Standard: 2x USB Ex ia (for keyboard, pointing device) 1x USB Ex ib (for USBi drive) 1x USB Ex e (LS/FS/HS 500 mA) E-Box PRO: 2x USB Ex ia (for keyboard, pointing device) 1x USB Ex ib (for USBi drive) 1x USB Ex e (LS/FS/HS 500 mA) 1x USB Ex e (LS/FS/HS for bus powered / passive devices only, 500 mA)		
Plug version USB X8	1x USB-A connector		
USB standard	USB 2.0, 480 Mbit/s		
Note on USB interfaces	The USB interfaces are based on the USB 2.0 standard. Ex-protection measures may result in a deviation from the standard (transfer rate or supply current).		
Serial interface	1x RS-232 / RS-422 / RS-485 switchable		
Further connections	Terminals for on/off button		
Status displays	LED's - device is live / power supply OK (orange) - device in operation (white) - access to system disk (white) - Ethernet link established / activity (white)		

 When using the fibre optic interfaces of ORCA devices, they must be connected and safely operated with other devices that comply with the limit values of Class 1 according to IEC 60825-1 or are classified as inherently safe optical radiation "op is" according to IEC 60079-28.

Battery	> 5 years		
Capacitor buffer	approx. 4 days		
RFID reader		-	optionally integrated C8
RFID reader chip type		-	NXP CLRC663
RFID operating frequency		-	13.56 MHz (HF)
RFID reading distance		-	<= 50 mm (depending on transponder)
Supported transponder media	Standard	Transponder media	
		Read and write	Read only
	ISO 14443 A and compatible	MIFARE® Classic Mini / 1K /4K MIFARE Ultralight®, MIFARE Ultralight® C MIFARE® DESFire®EV1 MIFARE® Smart MX MIFARE® Plus S / X MIFARE® Pro X NTAG 21x	LEGIC advant ATC UID / CSN *
	ISO 14443 B and compatible	SRI4K SRIX4K AT88RF020 66CL160S SR176	UID / CSN *
	ISO 15693 and compatible	EM4135 EM4043 EM4x33 EM4x35 I-Code SLI / SLIX M24LR16/64 TI Tag-it HF-I SRF55Vxx (my-d vicinity)	UID / CSN *
	ISO 18000-3M3	I-Code ILT-M	



Battery

- The self-discharge of the battery at room temperature is very low (<1%) but doubles for each additional 10 °C (25 °C = 1%/a >> 35 °C = 2%/a >> 45 °C = 4%/a ... 65 °C = 16%/a).
- In the case of permanently high temperatures, this self-discharge needs to be taken into account for any life cycle considerations.
- The cumulative time for which a battery is operated at 70 °C across its entire life cycle should not exceed 10 days.

UID / CSN

- Pre-programmed card number: Unique Identifier / Card Serial Number

17.1.2.1 Electrical data - device protection



Fuse

- For the external fuse protection of the ORCA device supply, R. STAHL HMI Systems GmbH recommends fuses with the following characteristic values.

Function / Equipment	E-Box Standard	E-Box PRO DC	E-Box PRO AC
Rated Current	2.5 A	4 A	1.25 A
Rated Voltage (minimum)	32 VDC	32 VDC	250 VAC
Breaking capacity	1500 A		
Melting integral (I ² t)	≥ 2 A ² s	≥ 10 A ² s	≥ 0.8 A ² s

17.1.3 Display

Function / Equipment	E52A M52A	E54A M54A	E59A M59A
Display-Version	TFT colour display		
Display version 2	16.7 million colours	16.2 million colours	16.7 million colours
Display size inch	12.1	15.6	21.5
Display size cm	30.7	39.6	54.6
Display resolution (supported)	1280 x 800 (native) 800 x 600 800 x 480 640 x 480	1920 x 1080 (native) 1680 x 1080 1280 x 1024 1024 x 768	
Display dimensions	16:10	16:9	
Display brightness	400 cd/m ²	450 cd/m ²	350 cd/m ²
Display contrast	1:800	1:1000	
Backlight	LED technology		
Life expectancy backlight	50,000 h at +25 °C		
Sensors	-		4
Touchscreen	yes		
Touch screen technology	projected, capacitive (PCAP), multi-touch		
Touchscreen activation	Touch, no activation pressure required		
Touchscreen input method	Fingers, thin glove or special glove		
Touch screen durability	very good		
Touchscreen resistance to scratching MoHS scale	>5		
Touchscreen resistance to scratching pencil hardness test ISO 15184	9H		
Touchscreen transmissivity / optics	very good		
Touchscreen surface contaminants	unaffected (however, can be affected by conductive fluids such as saltwater)		
Touchscreen abrasion resistance	no abrasion by finger or rubber		
Front plate	Glas, polyester on powder-coated aluminium		
Glass pane	hardened, impact-resistant		
Glass pane impact energy	4 J from a height of 40 cm		

17.1.4 Ambient conditions

Function / Equipment	PM E52A PM M52A	PM E54A PM M54A	PM E59A PM M59A	OS E59A OS M59A
Operating temperature range	-20 °C ... +55 °C			-20 °C ... +50 °C
Storage temperature	-40 °C ... +60 °C			
Relative humidity	10 to 90% at +40°C [+104 °F], non-condensing			
Heat dissipation	corresponds to the rated operating power of 27 - 60 W (92 - 205 BTU)			
Vibration (sinusoidal)	5 to 13.2 Hz: ±1 mm 13.2 to 100 Hz: ±0.7 g X, Y, Z axes			
Shock	15 g / 11 ms			
Pressurised operation	< = 20 mbar			
Altitude	for use up to 2000 m above sea level			

Corrosion resistance flowing mixed gas	ISA-S71.04 : 2013, severity G3 according to EN 60068-2-60 : 2015	
	Parameters	Test severity
	Hydrogen sulphide H ₂ S	50 ppb
	Nitrogen oxide NO _x	1250 ppb
	Chlorine gas CL ₂	10 ppb
	Sulphur dioxide SO ₂	300 ppb
	Temperature	25 °C
	Rel. humidity	50 %
	Duration	21 days
Location classes	according to DNV guideline CG-0339	
	only for version ORCA01ETCP6AC0000	
	Temperature	B
	Humidity	B
	Vibration	A
	EMC	A
	Enclosure	B

17.1.5 Mechanical data

Function / Equipment	PM E52A PM M52A	PM E54A PM M54A	PM E59A PM M59A	OS E59A OS M59A
Dimensions (W x H)	330 mm x 241 mm	415 mm x 310 mm	565 mm x 400 mm	708 mm x 524 mm
Total depth (D)	101 mm	with E-Box Standard: 108 mm		176 mm
		with E-Box PRO: 117 mm		
Wall cut-out (W x H)	310 mm x 221 mm	396 mm x 291 mm	547 mm x 382 mm	-
Cut-out tolerances	+1.0 mm / -0.5 mm		+0.5 mm	
Depth of cut-out (D)	92 mm	with E-Box Standard:		-
		98 mm	99 mm	-
		with E-Box PRO: 108 mm		-
Dimensions with keyboard (W x H x D)	-			708 mm x 794 mm x 404 mm
Enclosure design	-			Cleanroom suitability
Weight				
with E-Box Standard	ET = 10 kg	ET = 15 kg	ET = 21 kg	ET = 41.5 kg
	MT = 7 kg	MT = 9 kg	MT = 15 kg	MT = 35.5 kg
with E-Box PRO	-	ET = 19 kg MT = 11 kg	ET = 25 kg MT = 17 kg	ET = 45.5 kg MT = 37.5 kg
Material (front)	Glas, polyester on powder-coated aluminium			Stainless steel, glass and polyester on powder-coated aluminium
Material (back)	Aluminium			Stainless steel
Degree of protection (IP)	IP66 according to IEC 60529; IP65 according to IEC 60079-0			
Front enclosure protection type (IP)	IP66 according to IEC 60529; IP65 according to IEC 60079-0			
Enclosure back protection type (IP)	IP66 according to IEC 60529; IP65 according to IEC 60079-0			
Mounting option	Panel mount			Wall-mounting or mounted on stand / elbow
Mounting orientation	any			-
Wall thickness of installation wall	1.5 – 12 mm			-

17.2 Technical data E/M79A

17.2.1 General

Function / Equipment	PM E79A PM M79A	OS E79A OS M79A
Technology	Direct Monitor	
E-Box	PRO	
HMI-type	Panel-mount device	Operator Station
Enclosure type	-	ORCA OS enclosure OFR

17.2.2 Electrical data

Function / Equipment	E79A M79A
Power supply	24 VDC or 230 VAC
AC rated operational voltage	230 V
Voltage range AC	100 V - 240 V (+4.1 % / -15 %)
DC rated operational voltage	24 V
Voltage range DC	24 V (+30 % / -20 %)
Power consumption AC	1 A
Current consumption DC	3 A
Frequency range	47 – 63 Hz
Rated operational power	27 – 60 W
internal fuses AC	2 A
internal fuses DC	6.3 A
Terminal box	Power supply direct in integrated connection box (separate Ex e and Ex i compartments)
Connections	via screw terminals, green
Conductor type	Flexible conductors 0.2 to 2.5 mm ² (AWG24 to AWG12) rigid conductors 0.2 to 2.5 mm ² (AWG24 to AWG12) (details see chapter 8.5.8 Electric connections of interfaces X1, X2, X3, X4, X5, X6, X7, X9, X10, X11, X12 and X13)
max. operating voltage Um	250 V AC
Status displays	LED's - device is live / power supply OK (orange) - device in operation (white)

17.2.2.1 Electrical data - device protection

	<p>Fuse</p> <ul style="list-style-type: none"> For the external fuse protection of the ORCA device supply, R. STAHL HMI Systems GmbH recommends fuses with the following characteristic values.
---	---

Function / Equipment	E-Box PRO DC	E-Box PRO AC
Rated Current	4 A	1.25 A
Rated Voltage (minimum)	32 VDC	250 VAC
Breaking capacity	1500 A	
Melting integral (I ^{2t})	≥ 10 A ² s	≥ 0.8 A ² s

17.2.3 Display

Function / Equipment	E79A M79A
Display-Version	TFT colour display
Display version 2	16.7 million colours
Display size inch	21.5
Display size cm	54.6
Display resolution	1920 x 1080 (native)
Display dimensions	16:9
Display brightness	350 cd/m ²
Display contrast	1:1000
Backlight	LED technology
Life expectancy backlight	50,000 h at +25 °C
Sensors	4
Touchscreen	yes
Touch screen technology	projected, capacitive (PCAP), multi-touch
Touchscreen activation	Touch, no activation pressure required
Touchscreen input method	Fingers, thin glove or special glove
Touch screen durability	very good
Touchscreen resistance to scratching MoHS scale	>5
Touchscreen resistance to scratching pencil hardness test ISO 15184	9H
Touchscreen transmissivity / optics	very good
Touchscreen surface contaminants	unaffected (however, can be affected by conductive fluids such as saltwater)
Touchscreen abrasion resistance	no abrasion by finger or rubber
Front plate	Glas, polyester on powder-coated aluminium
Glass pane	hardened, impact-resistant
Glass pane impact energy	4 J from a height of 40 cm

17.2.4 Ambient conditions

Function / Equipment	PM E79A PM M79A	OS E79A OS M79A
Operating temperature range	-20 °C ... +55 °C	-20 °C ... +50 °C
Storage temperature	-40 °C ... +60 °C	
Relative humidity	10 to 90% at +40°C [+104 °F], non-condensing	
Heat dissipation	corresponds to the rated operating power of 27 - 60 W (92 - 205 BTU)	
Vibration (sinusoidal)	5 to 13.2 Hz: ±1 mm 13.2 to 100 Hz: ±0.7 g X, Y, Z axes	
Shock	15 g / 11 ms	
Pressurised operation	< = 20 mbar	
Altitude	for use up to 2000 m above sea level	
Corrosion resistance flowing mixed gas	ISA-S71.04 : 2013, severity G3 according to EN 60068-2-60 : 2015	
	Parameters	Test severity
	Hydrogen sulphide H ₂ S	50 ppb
	Nitrogen oxide NO _x	1250 ppb
	Chlorine gas CL ₂	10 ppb
	Sulphur dioxide SO ₂	300 ppb
	Temperature	25 °C
	Rel. humidity	50 %
	Duration	21 days

17.2.5 Mechanical data

Function / Equipment	PM E79A PM M79A	OS E79A OS M79A
Dimensions (W x H)	565 mm x 400 mm	565 mm x 400 mm
Total depth (D)	117 mm	176 mm
Wall cut-out (W x H)	547 mm x 382 mm	-
Cut-out tolerances	+0.5 mm	-
Depth of cut-out (D)	108 mm	-
Dimensions with keyboard (W x H x D)	-	708 mm x 794 mm x 404 mm
Enclosure design	-	Cleanroom suitability
Weight [kg]	ET = 25 kg MT = 17 kg	ET = 45.5 kg MT = 37.5 kg
Material (front)	Glas, polyester on powder-coated aluminium	Stainless steel, glass and polyester on powder-coated aluminium
Material (back)	Aluminium	Stainless steel
Degree of protection (IP)	IP66 according to IEC 60529; IP65 according to IEC 60079-0	
Front enclosure protection type (IP)	IP66 according to IEC 60529; IP65 according to IEC 60079-0	
Enclosure back protection type (IP)	IP66 according to IEC 60529; IP65 according to IEC 60079-0	
Mounting option	Panel mount	Wall-mounting or mounted on stand / elbow
Mounting orientation	any	-
Wall thickness of installation wall	1.5 – 12 mm	-

17.3 Cable glands

17.3.1 E-Box Standard

Cable gland	Type	HSK-M-Ex	
	Manufacturer	Hummel AG	
	Number	2x M16 / 1x M20	
	Thread size	M16 x 1.5 / M20 x 1.5	
	Clamping range	1x M16 = 4 ... 8 mm / 1x M16 = 5 ... 10 mm / M20 = 6 ... 12 mm	
	Width across flats	M16 = SW 17 or SW 19 / M20 = SW 22	
	Tightening torque	6 Nm / 5 Nm / 8 Nm	
Screw plug *	Type	V-Ms-VMQ-Ex	767DRM
	Manufacturer	Hummel AG	CMP
	Number	5x M16 / 2x M20	
	Screw plug size / width across flats	M16 = SW 19 M20 = SW 22	-
	Screw plug size / allen key	-	M16 = M8 M20 = M10
	Tightening torque	6 Nm / 8 Nm	

! The documentation from the manufacturer for the cable glands and screw plugs must be taken into account.

* The CMP screw plugs are only fitted to devices with NEC / CEC certification.

The E-Box is fully equipped with screw plugs.
There are 2x M16 / 1x M20 cable glands included as a set.

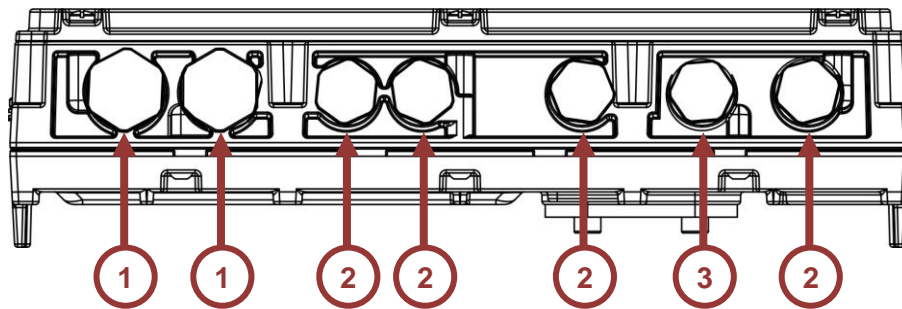

Item	Designation
1	Screw plug M20
2	Screw plug M16
3	Screw plug M16, space for cable gland 5 ... 10 mm for KB2 keyboard

! Additional cable glands can be ordered as a set (SAP 310903 - Supplemental cable glands kit E-Box STD)

17.3.2 E-Box PRO

Cable gland	Type	HSK-M-Ex
	Manufacturer	Hummel AG
	Number	6x M16 / 1x M20 / 1x M25
	Thread size	M16 x 1.5 / M20 x 1.5 / M25 x 1.5
	Clamping range	5x M16 = 4 ... 8 mm / 1x M16 = 5 ... 10 mm / M20 = 6 ... 12 mm / M25 = 14 ... 18 mm
	Width across flats	5x M16 = SW 17 or SW 19 / M20 = SW 22 / M25 = SW 30
	Tightening torque	6 Nm / 5 Nm / 8 Nm / 12 Nm
Screw plug	Type	767DRM
	Manufacturer	CMP
	Number	7x M16 / 3x M20 / 1x M25
	Screw plug size / allen key	M16 = M8 M20 and M25 = M10
	Tightening torque	6 Nm / 8 Nm / 12 Nm

! The documentation from the manufacturer for the cable glands and screw plugs must be taken into account.

The E-Box is fully equipped with CMP screw plugs.
There are 6x M16 / 1x M20 / 1x M25 cable glands included as a set.

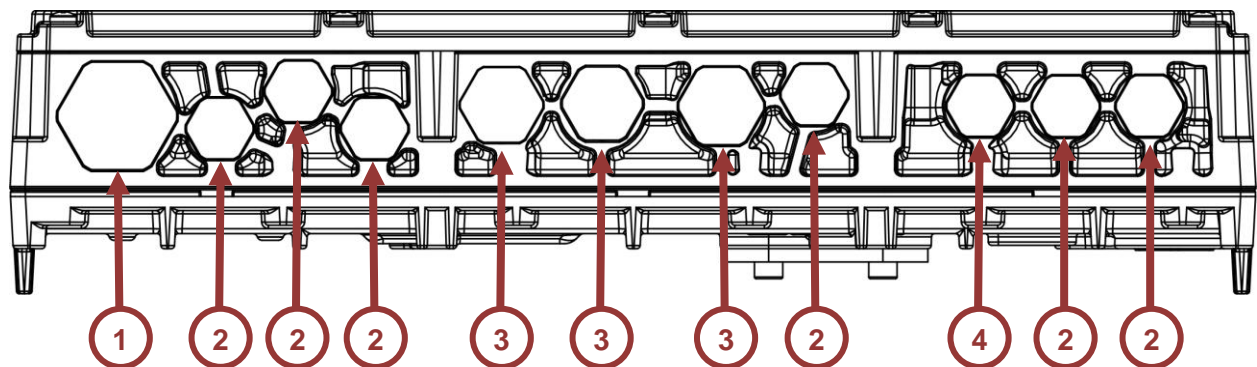

Item	Designation
1	CMP screw plug M25
2	CMP screw plug M16
3	CMP screw plug M20
4	CMP screw plug M16, space for cable gland 5 ... 10 mm for KB2 keyboard

! Additional cable glands can be ordered as a set (SAP 310902 - Supplemental cable glands kit E-Box PRO)

17.4 WLAN and Bluetooth adaptor

Function / Equipment	SK-WLAN-adaptor	SK-Bluetooth 4.0 adaptor
Manufacturer	Bartec GmbH	
Manufacturer part no.	17-71VZ-A010	17-71VZ-A020
Application range (zones)	1, 2, 21, 22	
Certification IECEX	IECEX IBE 11.0007X	
Certification ATEX	IBExU 05 ATEX 1117 X	
Gas explosion protection IECEX	Ex mb IIC T4 Gb	
Gas explosion protection ATEX	⊕ II 2G Ex mb IIC T4 Gb	
Dust explosion protection IECEX	Ex mb IIIC T120°C Db	
Dust explosion protection ATEX	⊕ II 2D Ex mb IIIC T120°C Db	
Certifications	ATEX, IECEX, NEC, CE-Code, INMETRO, CCC	
WLAN	IEEE802.11n IEEE802.11g IEEE802.11b	-
WLAN transmission rate	150 Mbit/s max.	-
WLAN frequency	2.4 GHz	-
Bluetooth	-	4.0, downwards compatible 2.0/2.1/3.0
Bluetooth range	-	up to 10 m in open terrain
Ambient temperature	-20 °C to +60 °C	
Enclosure material	Thermoplastic	
Ingress protection (IP)	IP66 (thread socket)	
Dimensions (WxHxD)		
Mounting orientation	any	
Wall thickness	1 to 6 mm	
Fixing	M30 x 1.5 suitable for through holes 30.3 mm	

17.5 Overview Hardware Revision ORCA01

HW-Rev.	Device type	Technical modifications	Modification date Hardware	BA version	BA date
01.01.01	ORCA01E* ORCA01M*	Initial	-	01.00.04	17.05.2023
01.01.02	ORCA01E*	Approval India (PESO, BIS)	06/2024	01.00.07	20.06.2024
	ORCA01E* ORCA01M*	Approval China (CCC, CNEx)			
	ORCA01ETCP 6AC0000	Marine / ship approval (DNV)			
01.01.03	ORCA01E* ORCA01M*	Approval USA / Canada (NEC / CE-Code) from UL	08/2024	01.00.08	05.08.2024
		CMP screw plugs for devices with NEC / CEC certification			

18 Appendix B

18.1 Connection values

Nominal voltage	Input voltage range	Rated frequency	max. power consumption
230 VAC	85 – 250 VAC	47 – 63 Hz	1 A
24 VDC	19.2 – 31.2 VDC	–	3 A

18.2 Intrinsically safe interfaces

18.2.1 X9 PB – on/off button (Ex ia)

X9: PB, on/off button (X9-1), GND (X9-2):

Max. output voltage	U_o	=	5.36	VDC				
Max. output current	I_o	=	45	mA				
Max. output power	P_o	=	0.061	W				
Trapezoidal output characteristics								
Max. external capacitance	C_o	=	64	20				μF
Max. external inductance	L_o	=	0.89	3.89				μH

C_o and L_o pairs directly above / underneath each other may be used.
For the connection of passive devices only.

18.2.2 X5 / X6 – USB 4/5 (Ex ia)

X5 / X6 – USB 4/5 terminals VBUS (X5/6-1), D- (X5/6-2), D+ (X5/6-3), GND (X5/6-4):

Max. output voltage	U_o	=	5.36	VDC				
Max. output current	I_o	=	249	mA				
Max. output power	P_o	=	0.55	W				
Trapezoidal output characteristics								
Max. external capacitance	C_o	=	65	46	32	25	21	μF
Max. external inductance	L_o	=	1	2	3	4	5	μH

C_o and L_o pairs directly above / underneath each other may be used.
For the connection of intrinsically safe passive devices only.

18.2.3 X7 / X8 – USB 6 (Ex ib)

X7 – USB terminals VBUS (X7-1), D- (X7-2), D+ (X7-3), GND (X7-4):

Max. output voltage	U_o	=	5.54	VDC				
Max. output current	I_o	=	0.757	A				
Max. output power	P_o	=	3.9	W				
Trapezoidal output characteristics								
Max. external capacitance	C_o	=	48.6	33.6	21.6	15.6	11.6	μF
Max. external inductance	L_o	=	1	2	3	4	5	μH

C_o and L_o pairs directly above / underneath each other may be used.
For the connection of intrinsically safe passive devices only.

X8 – USB A fixed socket

18.3 Optical interfaces

18.3.1 X15 / X16 – FO 1 / FO 2 type FX

Wavelength	=	1310	nm
------------	---	------	----

Optical radiation sources are used in EPL Gb or Gc and Db or Dc, which comply with the Class 1 limiting values according to IEC 60825-1.

18.3.2 X15 / X16 – FO 1 / FO 2 type SX

Wavelength	=	850	nm
------------	---	-----	----

Optical radiation sources are used in EPL Gb or Gc and Db or Dc, which comply with the Class 1 limiting values according to IEC 60825-1.

18.3.3 X15 / X16 – FO 1 / FO 2 type LX

Wavelength	=	1310	nm
------------	---	------	----

Optical radiation sources are used in EPL Gb or Gc and Db or Dc, which comply with the Class 1 limiting values according to IEC 60825-1.

18.4 Non intrinsically safe interfaces (Ex e)

18.4.1 X1 – Power supply

Nominal voltage			
• Device version AC	=	85 ... 250	VAC
• Device version DC	=	19.2 ... 31.2	VDC
Nominal current			
• Device version AC	=	max. 2	A
• Device version DC	=	max. 6.3	A
Nominal power	=	16 - 60	W
Max. input voltage	U_m	=	250 VAC
Frequency for AC	=	47 – 63	Hz

18.4.2 X2 / X10 – copper1 / copper2

Nominal voltage	=	5	VAC / VDC
Max. input voltage	U_m	=	250 VAC 30 VDC

18.4.3 X3 / X11 / X12 / X13 – USB

Nominal voltage	=	5	VAC / VDC
Max. input voltage	U_m	=	30 VAC

X11 / X12 / X13: for the connection of passive devices only

18.4.4 X4 – RSxxx

Nominal voltage	=	±12	VAC / VDC
Max. input voltage	U_m	=	30 VAC

19 Appendix C

19.1 Connection overview terminal assignment

19.1.1 E-Box Standard

19.1.1.1 Ex e terminals

Terminal	Pin	Designation (PCB) / view			Typical colour coding / plug type	Connection / function
X1 POWER	1	+24 V			Red	Power supply of the HMI device DC
	2	+24 V			Red	
	3	0 V			Black	
	4	0 V			Black	
X2 LAN 0		1000Base-TX	100Base-TX			Data cable Copper connection 1
	1	MDI0+	TX+		Orange / White	
	2	MDI0-	TX-		Orange	
	3	MDI1+	RX+		Green / White	
	4	MDI1-	RX-		Green	
	5	MDI2+			White / Blue	
	6	MDI2-			Blue	
	7	MDI3+			White / Brown	
X3 USB 0	1	VBUS			Red	USB connection
	2	D -			White	
	3	D +			Green	
	4	GND			Black	
X4 SERIAL		RS-232	RS-422	RS-485		Serial interface (COM) RS-232 / RS-422 / RS-485
	1	RTS	TxD-B	B		
	2	TxD	TxD-A	A		
	3	RxD	RxD-B			
	4	CTS	RxD-A			
	5	GND				

NOTE	<p>Connection of components with excessive voltages to X3 USB 0</p> <p>Non-compliance will trigger internal fuses and lead to failure of the USB interface !</p> <ul style="list-style-type: none"> A self-powered or bus-powered / passive device may be connected. <p>The voltage at this interface must not exceed the value specified according to USB 2.0. Higher voltage will trigger the fuses !</p>
-------------	---

NOTE	<p>Connection of components with excessive voltage to X4 SERIAL</p> <p>Non-compliance will trigger internal fuses and lead to failure of the serial interface !</p> <ul style="list-style-type: none"> The voltage at this interface must not go outside the range of -12 V ... +12 V. Higher or lower voltages will trigger the fuses !
-------------	--

19.1.1.2 Ex i terminals

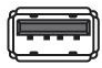
Terminal	Pin	Designation (PCB) / view	Typical colour coding / plug type		Connection / function
			General	Cable from KB2	
X5 USB 4	1	VBUS	Red	White	USB connection for KB2 max. 50 mA
	2	D -	White	Green	
	3	D +	Green	Yellow	
	4	GND	Black	Brown	
X6 USB 5	1	VBUS	Red	Red	USB connection for KB2 max. 50 mA
	2	D -	White	Grey	
	3	D +	Green	Pink	
	4	GND	Black	Blue	
X7 / X8 USB 6	1	VBUS	Red		USB connection (Terminals or sockets)
	2	D -	White		
	3	D +	Green		
	4	GND	Black		
			USB socket Type A		
X9 PB	1	PWRBTN			On / off button connection
	2	PWRBTN RETURN			

NOTE	<p>Short circuit of the terminal connection at X7 / X8 USB 6</p> <p>Non-compliance will trigger internal fuses and lead to failure of the USB interface !</p> <ul style="list-style-type: none"> You may only connect a bus-powered / passive device that is supplied by the ORCA device via the bus. Connect such a device via terminal X7 or the X8 USB terminal. Prevent short circuiting of the VBUS and D+ as well as the VBUS and D- terminals. Short-circuiting will trigger the fuses ! When connected to X7: Ex ib only applies for use in Zone 1/2 !
-------------	---

	<p>X9 PB terminals</p> <ul style="list-style-type: none"> Only connect a passive button.
---	--

19.1.2 E-Box PRO

19.1.2.1 Ex e terminals

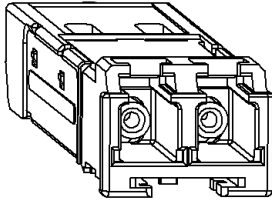
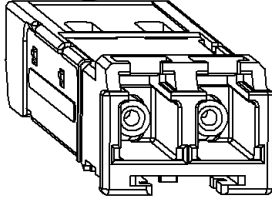
Terminal	Pin	Designation (PCB) / view		Typical colour coding / plug type	Connection / function
X1 POWER	0	Earth		Green-Yellow	Power supply of the HMI device (either AC or DC)
	1	+24 V / L		Red / Black	
	2	+24 V / L		Red / Black	
	3	0V / N		Black / Blue	
	4	0V / N		Black / Blue	
X2 * LAN 0		1000Base-TX	100Base-TX		Data cable
	1	MDI0+	TX+	Orange / White	Copper connection 1
	2	MDI0-	TX-	Orange	
	3	MDI1+	RX+	Green / White	
	4	MDI1-	RX-	Green	
	5	MDI2+		White / Blue	
	6	MDI2-		Blue	
	7	MDI3+		White / Brown	
	8	MDI3-		Brown	
X10 * LAN 1		1000Base-TX	100Base-TX		
	1	MDI0+	TX+	Orange / White	Copper connection 2
	2	MDI0-	TX-	Orange	
	3	MDI1+	RX+	Green / White	
	4	MDI1-	RX-	Green	
	5	MDI2+		White / Blue	
	6	MDI2-		Blue	
	7	MDI3+		White / Brown	
	8	MDI3-		Brown	
X15 * FO 1		 TX RX		LC duplex connector	
X16 * FO 2		 TX RX		LC duplex connector	Data cable FO connection 2 Type FX (100Base-FX) Type SX (1000Base-SX) Type LX (1000Base-LX)

X3 USB 0	1	VBUS			Red	USB connection
	2	D -			White	
	3	D +			Green	
	4	GND			Black	
X11 USB 3	1	VBUS			Red	USB connection (optional - assembly version)
	2	D -			White	
	3	D +			Green	
	4	GND			Black	
X13 USB 1	1	VBUS			Red	USB connection
	2	D -			White	
	3	D +			Green	
	4	GND			Black	
X4 SERIAL		RS-232	RS-422	RS-485		Serial interface (COM) RS-232 / RS-422 / RS-485
	1	RTS	TxD-B	B		
	2	TxD	TxD-A	A		
	3	RxD	RxD-B			
	4	CTS	RxD-A			
	5	GND				
X12 USB 2/A	1	VBUS			Red	USB connection (optional - assembly version)
	2	D -			White	
	3	D +			Green	
	4	GND			Black	
X12 USB 2/A	1	SPK+				Audio connection (optional - assembly version) (for ATOM processor only)
	2	-				
	3	-				
	4	SPK-				



- * The Ethernet connection depends on the version ordered.
The LC duplex slots are only available in the FO version.
When using the fibre optic interfaces of MANTA devices, they must be connected and safely operated with other devices that comply with the limit values of Class 1 according to IEC 60825-1 or are classified as inherently safe optical radiation "op is" according to IEC 60079-28.
The board is always fitted with all terminals, but they only have a function if required by the assembly version.
The X12 terminal is always optional and either a USB or an audio connection.

	<p>Terminals X13 USB 1 and X11 USB 3</p> <ul style="list-style-type: none"> You may only connect a bus-powered / passive device that is supplied by the ORCA device via the bus. <p>Terminals X12 USB 2/A</p> <ul style="list-style-type: none"> If fitted with USB module: you may only connect a bus-powered / passive device that is supplied by the ORCA device via the bus. If fitted with audio module: you may only connect a passive speaker.
---	--

<div style="border: 1px solid black; padding: 5px; display: inline-block;">NOTE</div>	<p>Connection of components with excessive voltages to X3 USB 0</p> <p>Non-compliance will trigger internal fuses and lead to failure of the USB interface !</p> <ul style="list-style-type: none"> A self-powered or bus-powered / passive device may be connected. <p>The voltage at this interface must not exceed the value specified according to USB 2.0. Higher voltage will trigger the fuses.</p>
---	--

<div style="border: 1px solid black; padding: 5px; display: inline-block;">NOTE</div>	<p>Connection of components with excessive voltage to X4 SERIAL</p> <p>Non-compliance will trigger internal fuses and lead to failure of the serial interface !</p> <ul style="list-style-type: none"> The voltage at this interface must not go outside the range of -12 V ... +12 V. Higher or lower voltages will trigger the fuses.
---	---

19.1.2.2 Ex i terminals

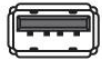
Terminal	Pin	Designation (PCB) / view	Typical colour coding / plug type		Connection / function
			General	Cable from KB2	
X5 USB 4	1	VBUS	Red	White	USB connection for KB2 max. 50 mA
	2	D -	White	Green	
	3	D +	Green	Yellow	
	4	GND	Black	Brown	
X6 USB 5	1	VBUS	Red	Red	USB connection for KB2 max. 50 mA
	2	D -	White	Grey	
	3	D +	Green	Pink	
	4	GND	Black	Blue	
X7 / X8 USB 6	1	VBUS	Red		USB connection (Terminals or sockets)
	2	D -	White		
	3	D +	Green		
	4	GND	Black		
			USB socket Type A		
X9 PB	1	PWRBTN			On / off button connection
	2	PWRBTN RETURN			

NOTE**Short circuit of the terminal connection at X7 / X8 USB 6**

Non-compliance will trigger internal fuses and lead to failure of the USB interface !

- You may only connect a bus-powered / passive device that is supplied by the ORCA device via the bus.
- Connect such a device via terminal X7 or the X8 USB terminal.
- Prevent short circuiting of the VBUS and D+ as well as the VBUS and D- terminals. Short-circuiting will trigger the fuses !
- When connected to X7: Ex ib only applies for use in Zone 1/2 !

**X9 PB terminals**

- Only connect a passive button.

19.1.3 Direct Monitor

19.1.3.1 Ex e terminals

Terminal	Pin	Designation (PCB) / view	Typical colour coding / plug type	Connection / function
X1 POWER	0	Earth	Green-Yellow	Power supply of the HMI device (either AC or DC)
	1	+24 V / L	Red / Black	
	2	+24 V / L	Red / Black	
	3	0V / N	Black / Blue	
	4	0V / N	Black / Blue	
X3 USB 0	1	N.C.	Red	USB monitor connection
	2	D -	White	
	3	D +	Green	
	4	GND	Black	
X2		LAN 0		no function
X4		SERIAL		no function
X10		LAN 1		no function
X11		USB 3		no function
X12		USB 2/A		no function
X13		USB 1		no function

 All terminals are located on the board but only terminal X3 is functionally present for the connection of the monitor.

19.1.3.2 Ex i terminals

Terminal	Pin	Designation (PCB) / view	Typical colour coding / plug type	Connection / function
X5		USB 4		no function
X6		USB 5		no function
X7 / X8		USB 6		no function
X9		PB		no function

 All terminals are located on the board but have no function.

20 Appendix D

20.1 Variation of operating temperature range

The devices' operating temperature range is impacted by how they are mounted. The minimum and maximum permitted operating temperature may vary depending on their mounting type.







These values are listed in the table below.



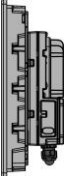

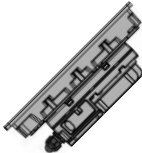
NOTE	<p>Exposure to direct sunlight might contribute to further heating up the device and may result in a further reduction of the maximum permitted operating temperature. We recommend you protect the device from direct sunlight.</p> <p>Wind may cool down the device and thus have an impact on the minimum operating temperature.</p>
-------------	---

	The storage temperature is not impacted by the type of installation.
---	--

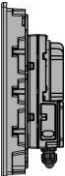
The following values apply:

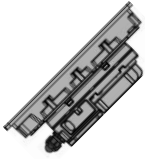
- LTC = lower ambient temperature in °C
-20 °C
- LTF = lower ambient temperature in °F
+14 °F
- HTC = highest permissible ambient temperature in °C
- HTF = highest permissible ambient temperature in °F

Screen position	Inclination	Description	Highest permissible ambient temperature
		Landscape, horizontal 90° free standing	HTC = +55 °C HTF = +131 °F
		Landscape, horizontal 45° free standing	HTC = +55 °C HTF = +131 °F
		Landscape, horizontal 0° free standing Minimum distance 10 cm below device	HTC = 55 °C HTF = +131 °F
		Portrait vertical 90°, free standing	HTC = +55 °C HTF = +131 °F

Screen position	Inclination	Description	Highest permissible ambient temperature
		<p>Portrait vertical 45°, free standing</p>	<p>HTC = +55 °C HTF = +131 °F</p>
		<p>Landscape, horizontal Mounted in enclosure any degree of inclination</p>	<p>HTC = +50 °C HTF = +122 °F</p>
		<p>Portrait, horizontal Mounted in enclosure any degree of inclination</p>	<p>HTC = +50 °C HTF = +122 °F</p>

21 Appendix E

21.1 Disposal / restricted substances

Disposal of old electric and electronic devices, packaging and used parts is subject to regulations valid in whichever country the device has been installed.

For countries under the jurisdiction of the EU the corresponding WEEE directive applies.

The devices are classified according to the table below:

Directive	WEEE II Directive 2012/19/EU
Valid	from 15.08.2018
Category	SG2 screens, monitors, devices with monitors >100 cm ²

R. STAHL HMI Systems GmbH meets the requirements of directive 2012/19/EU (WEEE) and is registered under the number DE 15180083.

We shall take back our devices according to our General Terms and Conditions.

21.1.1 Declaration of substances and restricted substances

This declaration is based on the procedure described in the international standard and directives as listed in the table below:

- IEC 62474 : 2018 (DIN EN IEC 62474 : 2019-09)
- (EG) Nr. 1907/2006 (REACH)
- Directive 2011/65/EU (RoHS)
- Resolution MEPC.269(68) "International Maritime Organization" (IMO); particularly "2015 Guidelines for the Development of the Inventory of the Hazardous Materials" (IHM)

21.1.1.1 Declarable substance groups

ECHA Legal Entity UUID of the R. STAHL HMI Systems GmbH:
ECHA-a4dd94d5-bcd2-405d-8fdd-010a535d7e87

SCIP number:

Component	Designation	Mass (g)	Declarable Substance Groups and Substances (IEC 62474 database)	CAS No.	Mass %	Exemption (acc. to directive)
CR2032 MFR	Lithium button cell battery	2.8	1,2 Dimethoxyethane (DME) EINECS 203-794-9	110-71-4	over 0.1 by weight	-

21.1.1.2 RoHS directive 2011/65/EC

The devices meet the requirements of RoHS Directive 2011/65/EU.

21.1.1.3 IMO Resolution MEPC.269(68)

The devices meet the requirements of the MEPC.269(68) Resolution of the "International Maritime Organization" (IMO), in particular the "2015 Guidelines for the Development of the Inventory of the Hazardous Materials" (IHM).

22 Appendix F

22.1 Material resistance

This section lists the material resistance to chemicals of ORCA components that may come into contact with the external environment.

The selection of the individual chemicals listed does not claim to be complete.

22.1.1 Material

Item	Designation	Material
1	Front plate	Aluminium
2	Powder coating	Tiger Drylac Series 29
3	Enclosure	Aluminium
4	Front plate seal	Silicone VMQ
5	Front plate foil	MacDermid Autotex XE Polyester
6	Front glass	Glass, thermally toughened

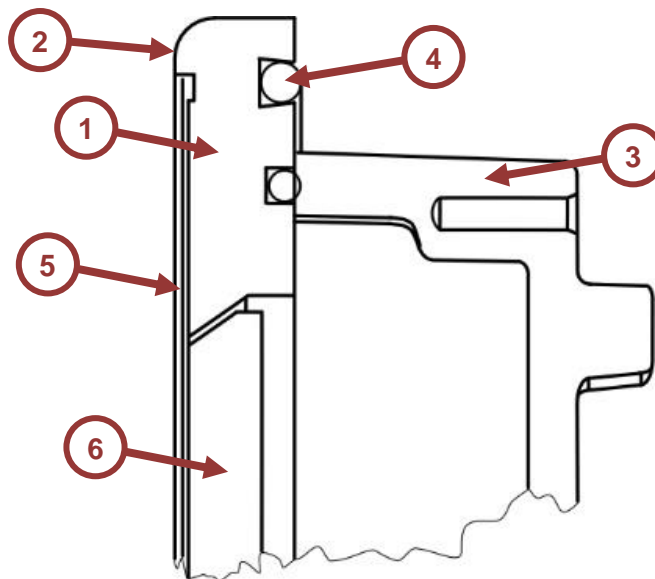

22.1.1.1 Aluminium

Aluminium is relatively corrosion-resistant and very durable in air and water. In air, aluminium forms an oxide layer that protects against corrosion.

There are various lists on the Internet for resistance to chemicals, so that a list can be dispensed with at this point.

22.1.1.2 Powder coating

Chemicals	Resistance					
	7 days	1 month	3 months	6 months	9 months	12 months
Ammonia 10 %	moderate	moderate	-	-	-	-
Sodium hydroxide solution 10 %	yes	yes	moderate	-	-	-
Soda 10 %	yes	yes	yes	yes	yes	yes
Acetic acid 10 %	yes	yes	moderate	-	-	-
Lactic acid 10 %	yes	yes	yes	yes	yes	yes
Phosphoric acid 10 %	yes	yes	yes	yes	yes	yes
Nitric acid 10 %	yes	yes	moderate	moderate	-	-
Hydrochloric acid 10 %	yes	yes	yes	moderate	moderate	moderate
Sulfuric acid 32 %	yes	yes	moderate	moderate	moderate	-
Ethanol 96 %	yes	yes	yes	yes	yes	yes
Isopropyl alcohol	yes	yes	yes	yes	yes	yes
Ethyl acetate	no	-	-	-	-	-
Toluene	no	-	-	-	-	-
Xylene	no	-	-	-	-	-
Diesel	yes	yes	yes	yes	yes	yes
FAM-Testing fuel	moderate	moderate	moderate	no	no	no
Petrol	yes	yes	yes	yes	yes	yes
Seewater	yes	yes	yes	yes	yes	yes

22.1.1.3 Front plate seal

The VMQ material has very good weathering and ageing resistance, excellent rubber elastic properties and outstanding temperature resistance.

The tables contain an evaluation of the chemical resistance of VMQ to the respective chemical. Unless otherwise stated, the data refer to room temperature.

No to little change in properties		
Aluminium phosphate (aqueous solution)	Aluminium sulphate (aqueous solution)	Ammonia (gaseous, hot)
Ammonia (gaseous, cold)	Ammonium hydroxide (concentrated)	Ammonium phosphate (aqueous solution)
Arsenic acid	Barium chloride (aqueous solution)	Barium hydroxide (aqueous solution)
Barium sulphate (aqueous solution)	Barium sulphide (aqueous solution)	Cottonseed oil
Beer	Boric acid	Calcium chloride (aqueous solution)
Calcium hydrogen sulphite (aqueous solution)	Calcium hydroxide (aqueous solution)	Dimethyl ether (methyl ether)
Developing fluid (photography)	Natural gas	Peanut oil
Vinegar	Acetic acid, 30%	Ethyl alcohol (ethanol)
Ethylenediamine	Ethylene glycol	Fish oil

Fluorolube	Freon T-P35	Fyrquel (Cellulube)
Gelatine	Glucose (dextrose)	Glycerine (Glycerol, oil sweet; E422)
Glycol (1,2-diol)	Green sulphate broth	Blast furnace gas
Isobutyl alcohol (isobutanol)	Isopropyl alcohol (isopropanol)	Potassium chloride (aqueous solution)
Potassium cyanide (aqueous solution)	Potassium dichromate (aqueous solution)	Potassium copper cyanide (aqueous solution)
Potassium nitrate (aqueous solution)	Potassium sulphate (aqueous solution)	Lime-Sulphur Solution
Carbon dioxide	Carbon monoxide	Coconut oil
Copper chloride (aqueous solution)	Copper cyanide (aqueous solution)	Copper sulphate (aqueous solution)
Glue (DIN 16920)	Linseed oil	Magnesium chloride (aqueous solution)
Magnesium sulphate (aqueous solution)	Maize oil	Methyl alcohol (methanol)
Methyl ether (dimethyl ether)	Milk	Lactic acid (cold)
Monomethyl ether	Sodium borate (aqueous solution)	
Sodium bicarbonate (aqueous solution)	Sodium bisulphite (aqueous solution)	Sodium chloride (aqueous solution)
Sodium cyanide (aqueous solution)	Sodium sulphate (aqueous solution)	Sodium thiosulphate (aqueous solution)
Nickel chloride (aqueous solution)	Nickel sulphate (aqueous solution)	Ozone
Propyl alcohol (propanol)	Castor oil	Cane sugar liquid
Beet sugar liquid	Sacharose solution (cane sugar)	Salt water
Oxygen (cold)	Soap solution	Mustard gas
Silver nitrate	Soda ash, free of water of crystallisation	Soya oil (soybean oil)
Spirit	Nitrogen	Water
Tartaric acid	Whiskey and wine	Zinc chloride (aqueous solution)
Zinc sulphate (aqueous solution)	Citric acid	

Minor to moderate change in properties		
Waste water (according to DIN 4045)	Acetaldehyde	Acetamide (acetic acid amide)
Acetylene (ethyne)	Acrylic acid ethyl ester	Aluminium chloride (aqueous solution)
Aluminium chloride (aqueous solution)	Aluminium fluoride (aqueous solution)	Aluminium nitrate (aqueous solution)
Formic acid (methanoic acid)	Ammonium nitrite (aqueous solution)	Malic acid
Benzaldehyde (artificial bitter almond oil)	Benzyl alcohol	Bleach solution
Lead nitrate (aqueous solution)	Lead sulphamate (aqueous solution)	Borax solution (disodium tetraborate)
Bordeaux blend	Bunker oil	Butter (animal fat)
Butyl alcohol (butanol)	Calcium hypochlorite (aqueous solution)	Calcium nitrate (aqueous solution)
Calcium sulphide (aqueous solution)	Carbitol (ethyl diglycol)	Chlorox (sodium hypochlorite)
Decan	Diacetone alcohol (Diacetol)	Dibutyl phthalate (DBP)
Dibutyl sebacate (DBS)	Diethylamine	Diethylene glycol (digol)
Diethylsebacate	Dimethylformamide (DMF)	Iron(III) chloride (aqueous solution)
Iron(III) sulphate (aqueous solution)	Acetic acid, glacial acetic acid	Ethanolamine (aminoethanol) (MEA)
Ethyl acetate (ethyl acetate)	Ethyl acetoacetate	Formaldehyde (RT) (methanal)
Fumaric acid	Generator gas	Tannic acid (tannin)
n-Hexaldehyde	Hexanol	Cod liver oil
Lime bleach	Cobalt dichloride (aqueous solution)	Carbon dioxide
Coke oven gas	Lard (animal fat)	Lye (alkali lye)
Linoleic acid	Lactic acid (hot)	Mineral oil
Monoethanolamine	Sodium hydroxide (aqueous solution)	Sodium hypochlorite (aqueous solution)
Sodium perborate (aqueous solution)	Octyl alcohol (octanol)	Oxalic acid (ethanedioic acid, clover acid)
Petroleum (< 121°C)	Vegetable oil	Phosphoric acid (20%)
Pyrrrole	Salmiak (ammonium chloride)	Nitric acid (diluted)
Oxygen (93 - 204 °C)	Sulphur dioxide (liquid under pressure)	Sulphur dioxide (wet)
Sulphur dioxide (dry)	Sulphur hexafluoride	Sulphur trioxide
Stearic acid (octadecanoic acid)	Tar, Bituminous	Animal fats
Transformer oil	Chrome plating solution	Hydrogen peroxide (90%)

Tin dichloride (aqueous solution)	Tin tetrachloride (aqueous solution)	
--------------------------------------	---	--

Moderate to strong change of properties		
Acetone	Acetyl chloride (acetic acid chloride)	Ammonia, anhydrous
Aniline dye	Benzoic acid (E 210)	Hydrogen cyanide
Chromic acid	Dibenzyl sebacate	Dibutylamine
Diocetyl phthalate (DOP)	Diocetyl sebacate (DOS)	Diphenyl oxide
Dowtherm oil	Iron(III) nitrate (aqueous solution)	Acetic anhydride
Ethyl cellulose	Ethylene chlorohydrin	Ethyl mercaptan (ethanethiol)
Fatty acids	Freon TA	Freon TMC
Hydraulic oils (mineral oil based)	Hydrazine (diamide, diazane)	Potassium hydroxide (aqueous solution)
Lindol (hydraulic fluid)	Methyl butyl ketone (propylacetone)	Olive oil
Petroleum gas, liquid (LPG)	Phosphoric acid (45%)	Propyl acetone (methyl butyl ketone)
Hydrochloric acid (cold) 37	Sulphur	Sulphur chloride (aqueous solution)
Hydrogen sulphide (wet, cold)	Hydrogen sulphide (wet, hot)	Silicone grease
Radiation	Tricresyl phosphate (TCP)	Trioctyl phosphate
Water vapour (< 149 °C)	Hydrogen gas	

Not recommended		
Acetophenone	Acrylonitrile	Aluminium acetate (aqueous solution)
Amylacetate (acetic acid amyl ester)	Amyl alcohol (pentanol)	Amylchloronaphthalene
Amylnaphthalene	Aniline (aminobenzene)	Aniline hydrochloride
Asphalt	Banana oil (amyl acetate)	Pickling solution
Petrol (nitrobenzene, ligroine)	Benzene	Benzenesulfonic acid
Benzyl chloride	Biphenyl (diphenyl, phenylbenzene)	Lead acetate (aqueous solution)
Bromine, anhydrous	Bromobenzene	Bromine trifluoride
Bromine water	Hydrobromic acid	Hydrobromic acid (40%)
Butadiene	Butane	Butyl acetate (acetic acid butyl ester)
Butylamine	Butylene (Buten)	Butylethyldiglycol (CARBITOL)
Butyraldehyde (Butanal)	Calcium acetate (aqueous solution)	Carbolic acid (phenol)
Cellosolve (ethylene glycol ether)	Cellosolve acetate (glycol acetate)	China Wood Oil (China Tung Oil)

Chlorine, wet	Chlorine, dry	1-Chloro-1-nitroethane
Chloroacetone	Chlorobenzene	Bromochloromethane
Chlordodecane	o-Chlornaphthalene	Chloroform (trichloromethane)
Chloroprene (chlorobutadiene)	Chlorosulphuric acid (chlorosulphonic acid)	Chlorotoluene
Chlorine trifluoride	Cumene (Isopropylbenzene)	Cyclohexane (hexamethylene)
Cyclohexanol (hexahydrophenol, anol)	Cyclohexanone (Pimelin Ketone, Anon)	p-Cymene (Cymol)
Decalin (decahydronaphthalene)	Diacetone	Dibromoethylbenzene
Dibutyl ether	o-Dichlorobenzene	Dichloroisopropyl ether
Diesel oil	Diethylbenzene	Diisobutylene (Isooctene)
Diisopropyl ketone	Diisopropylidene acetone (Phoron)	Dimethylaniline (xylidine, aminoxylol)
Dinitrotoluene (DNT)	Dioxane	Dioxolan (glycol methyl ether)
Dipentene (paint solvent)	Diphenyl (biphenyl, phenylbenzene)	Epichlorohydrin
Ethan	Ethyl benzoate	Ethylbenzene
Ethyl cellosolve (glycol diethyl ether)	Ethyl chlorocarbonate	Ethyl chloroformate
Ethyl chloride (chloroethane)	Ethylene chloride	Ethylene dichloride (1,2-dichloroethane)
Ethylene oxide (oxirane, epoxy)	Ethylene trichloride	Ethyl ether (diethyl ether)
Ethyl oxalate	Ethylpentachlorobenzene	Fluorine (liquid)
Fluorobenzene	Hydrofluoric acid, conc. (cold)	Hydrofluoric acid, conc. (hot)
Hydrofluoric acid, anhydrous	Freon 11 (trichlorofluoromethane)	Freon 12 (dichlorodifluoromethane)
Freon 13 (chlorotrifluoromethane)	Freon 13B1	Freon 21 (dichlorofluoromethane)
Freon 22 (chlorodifluoromethane)	Freon 112	Freon 113 (trichlorotrifluoroethane)
Freon 114 (dichlorotetrafluoroethane)	Freon 114B2	Freon BF
Freon MF	Freon TC	Freon TF
Freon T-WD602	Furfural (Furfurol)	Electroplating solution for chrome
Galvanising solution for other metals	Halowax oil	Hexafluorosilicic acid
Hexane	n witches-1	Iodine pentafluoride
Isooctane	Isophorone	Isopropyl acetate
Isopropyl chloride	Isopropyl ether	Potassium acetate (aqueous solution)

Paraffin (illuminating petroleum; DIN 51636)	Carbon disulphide (carbon disulphide)	Carbon tetrachloride
Coal tar (creosote)	Aqua regia	Creole acid
Creosote coal tar	Kresol (methylphenol)	Copper acetate (aqueous solution)
Lacquer	Lacquer (cellulose lacquer)	Lacquer (solvent)
Lavender oil	Ligroin (nitrobenzene)	Mesityl oxide
Methane	Methyl acetate (methyl acetate)	Methyl acrylate
Methyl cellosolve (methylene glycol ether)	Methyl chloride (monochloromethane)	Methylene chloride (dichloromethane)
Methyl ethyl ketone (MEK)	Methyl isobutyl ketone (MIBK)	Methyl methacrylate (MMA)
Methylpentane	Monochlorobenzene	Naphtha
Naphthalene (naphthalene)	Naphthenic acid	Sodium acetate (aqueous solution)
Sodium nitrate (aqueous solution)	Sodium peroxide (aqueous solution)	Sodium phosphate (aqueous solution)
Neville Winther Acid	Nickel acetate (aqueous solution)	Nitrobenzene
Nitrobenzene (petroleum ether)	Nitroethane	Nitromethane
Octachlorotoluene	Octadecan	n-octane
Oleic acid	Palmitic acid (n-hexadecanoic acid)	Paraffin oil (white oil)
Perchloric acid	Petroleum (> 121°C)	Phenol (carbolic acid)
Phenylbenzene	Phenylethylether	Phoron (diisopropylidene acetone)
Picric acid (2,4,6-trinitrophenol)	Pinen	Piperidine (hexahydropyridine)
Propane	i-Propyl acetate	n-Propyl acetate (acetic acid propyl ester)
Propyl nitrate	Propylene (propene)	Propylene oxide
Pyridine	Rapeseed oil	RJ-1 (Mil-F-25558B)
RP-1 (Mil-R-25576C)	Nitric acid (concentrated)	Nitric acid (red, fuming)
Hydrochloric acid (hot) 37	Lubricating oil, petroleum	Sulphuric acid (20% oleum)
Sulphuric acid (diluted)	Sulphuric acid (concentrated)	sulphurous acid
Silicate ester	Nitrogen tetroxide	Styrene, monomer (phenylethylene)
Sulphite lye	Turpentine	Tetrabromoethane
Tetrabromomethane (carbon tetrabromide)	Tetrachloroethylene (Per)	Tetrahydrofuran (THF)
Tetralin (tetrahydronaphthalene)	Titanium tetrachloride	Toluene diisocyanate (TDI)

Toluene (methylbenzene)	Fuel oil	Tributyl mercaptan
Tributyl phosphate (TBP)	Trichloroethane	Trichloroethylene (Trichloroethene, Tri) (TCE)
Tung oil (China wood oil)	Turbine oil	Unsymmetrical dimethylhydrazine (UDMH)
Water vapour (> 149 °C)	Xylene (xylene, dimethylbenzene)	Xylidine (aminoxylene, dimethylaniline)
Zinc acetate (aqueous solution)		

Other properties

Property	Typical value	Test method
Hardness	Shore A 50 ± 5	ASTM D 2240
Compression set (24 h / 175 °C)	18%	ASTM D 395/B
Operating temperature (air)	-50 °C to +190 °C	
Flame class	V-0	UL 94 / IEC 60695-11-10

22.1.1.4 Front plate foil

The front plate foil contains a UV-absorbing chemical that greatly increases resistance to yellowing and premature embrittlement in outdoor applications.

With continuous contact with chemicals, some chemicals begin to remove the UV absorber, reducing its UV resistance.

The front plate foil will withstand exposure to the following chemicals for 5 hours without significant visible change or loss of UV resistance. For longer durations, both the visual appearance (colour) and UV resistance may be affected.

Resistance of 5 hours				
Diesel	Ammonia 2 % *	Acetic acid 5 %	Cutting oil	Hydraulic oil
Glycerine	Sodium hydroxide *	Hydrochloric acid 10 %	Paraffin oil	Salt water
White spirit *	Potassium carbonate solution *	Nitric acid 10 %	Pure turpentine	Water
SBP 60/95 *	Potassium ferricyanide	Phosphoric acid ≥ 30 %	Linseed oil	
Spirit	Sodium carbonate solution *	Sulphuric acid 10 %	Castor oil	

* Extremely faint texture sheen was noted on contact with these chemicals.

Contact with the following chemicals under the above conditions will result in a slight sheen to the texture and a reduction in the UV resistance of the product.

Chemicals		
1.1.1. trichloroethane *	Ethyl acetate	Methanol
Acetaldehyde	Formaldehyde solution	Methyl ethyl ketone
Acetone	Formic acid 50 %	Toluene *
Cyclohexanol	Glycol	Xylene *
Cyclohexanone	Industrial methylated spirit	
Ether	Isopropyl	

* A white stain was observed on the film surface upon contact with these chemicals.

The front panel film withstands exposure to the following household chemicals for 5 hours at 50 °C.

Chemicals		
Bleach / Toilet Cleaner	Cleaner for hard surfaces	Cleaning fluid
Cream cleanser	Washing powder solutions	Window cleaner
Fabric softener	Washing-up liquid	Tomato ketchup

The front panel film is **NOT** resistant to the following chemicals:

Chemicals		
Benzyl alcohol	Concentrated mineral acids	High pressure steam above 100 °C
concentrated lye	Methylene chloride	

More features

Property	Typical value	Test method
Haze: Fine Velvety	58% ± 5% 71% ± 5%	ASTM D1003
Total light transmittance	92% ± 2%	ASTM D1003
Gloss level (60°): Fine Velvety	7 ± 1.5 GU 4.5 ± 1 GU	ASTM D2457 (modified according to test method 022)
Yellowness index	< 5	ASTM E313
Adhesion of the hard coating	passed	Test method 080
Lifetime	> 5 million operations	Test method 003
Tensile strength at break	172 – 190 N/mm ²	ASTM D882
Breakdown voltage: 150 µm 200 µm	16 - 18 kV 18 - 20 kV	ASTM D149
Dimensional stability	0.2% maximum shrinkage MD at 120 °C	Test method 094
Thickness all types	Nominal ± 10%	Test method 096
Maximum processing temperature	120 °C	
Maximum operating temperature (Low humidity < 10% RH)	85 °C	Test method 012
Maximum operating temperature (High humidity 85% RH)	85 °C	Test method 012
Minimum operating temperature	-40 °C	Test method 012

22.1.1.5 Front glass

Glass has a fairly high resistance to most liquids or gases. Only hydrofluoric acid is able to attack glass. A reaction occurs when aqueous solutions come into contact with the glass surface.

Characteristics

- unadulterated colour perception
- reflection-free view
- improved light transmittance
- hard, corrosion-resistant multi-layer coating

22.2 Coating compatibility

Function / Equipment	PM E52A PM M52A	PM E54A PM M54A	PM E59A PM M59A	OS E59A OS M59A
Material P1	VMQ			-
Material P2	-			HokoFLEX®
Material usage P1	Front plate seal			-
Material usage P2	-			Door seal stainless steel enclosure
Test method	Paint wetting impairment substances according to VDMA 24364			
Paint material	Spray paint LLS 0U3 B9A (Candy white))		Spray paint L 090 E03 (Alpine white)	
Product group	C			
Test class	C 2 - Blow-off			
Test result	no surface disturbances			

23 Appendix G

23.1 Defective pixels

As a result of the manufacturing process (production tolerances and errors) for the displays they may be delivered with defective pixels. These potential defective pixels are not a display or HMI error or defect, provided they are within the range of the specification below.

23.1.1 Terminology

Defective pixels Pixels or sub-pixels that do not perform as expected and are either always on or always off

Pixel Image point on the display consisting of 3 sub-pixels in the basic colours red, green and blue



Dot Sub-pixel in the basic colour red, green or blue



Bright Sub-pixel (dot) to which light is passing through, creating a bright dot that is on

Dark Sub-pixel (dot) to which no light is passing through, creating a dark dot that is off

Adjacent dots Dots positioned next to one another, horizontally, vertically or diagonally, bright or dark (e.g. the following pattern and sub-pixels)

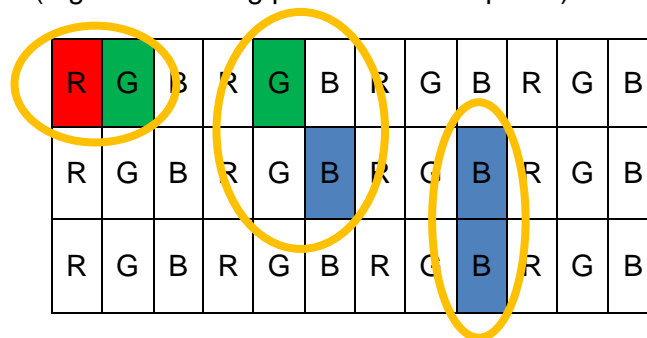

Distance between Dots Definition of distance between two defective dots horizontal, vertical or diagonal, bright or dark (e.g. the following pattern and sub-pixels)

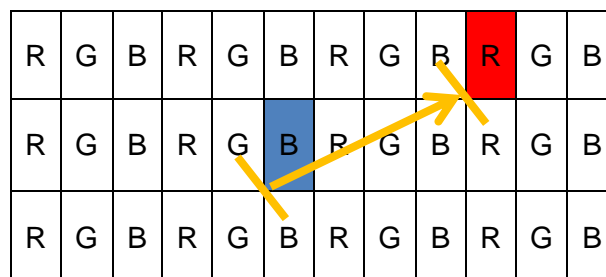

23.1.2 Display specification

Type of defect / description	max. number of permitted defects		
	12" display	15" display	22" display
Linear defect (horizontal, vertical)	not acceptable		
Defective pixels			
bright dots	≤ 2	≤ 2	≤ 2
dark dots	≤ 3	≤ 3	≤ 5
total number of dots	≤ 3	≤ 5	≤ 5
adjacent dots			
2 bright dots	≤ 0 pairs	≤ 1 pairs	≤ 1 pairs
more than 3 bright dots	not acceptable		
2 dark dots	≤ 1 pairs	≤ 1 pairs	≤ 2 pairs
more than 3 dark dots	not acceptable		
Distance between the dots			
between 2 bright dots	not defined	not defined	not defined
between 2 dark dots	not defined	not defined	not defined
between 1 bright and 1 dark dot	not defined	not defined	not defined
ND filter for mura effects, bright and dark dots	not defined	not defined	5 %

23.2 Optical specification front glass

For glass with a surface of $>0.1\text{m}^2$ to $\leq 0.35\text{ m}^2$

Type of defect / description	Value	Corresponds to specification on the basis of DIN10110
Largest point defect	max. 0.4 mm^2	0.63 - 1 mm
max. number		7
additional small point defects	max. $0.16 - 0.4\text{ mm}^2$	0.4 - 0.63 mm
max. number		7
In general, any number of point defects smaller than the following specified surface are always permitted, that is, they are not considered to be defects.		
Surface	$< 0.16\text{ mm}^2$	$< 0.4\text{ mm}$
Scratches		
max. Width		0.16 mm
max. Number		7
max. Length		42 mm
Cumulative length of all scratches		42 mm
In general, any number of scratches narrower than the following specified width are always permitted, that is, they are not considered to be defects.		
Width		$< 0.16\text{ mm}$
Minimum distance of defects		70 mm



The defect sizes are listed here as the square root of the surface in mm.

$$\text{Defect size} = \sqrt{\text{defect length} * \text{defect width}}$$

23.2.1 Test criteria

Test setup: transmitted light / transmission

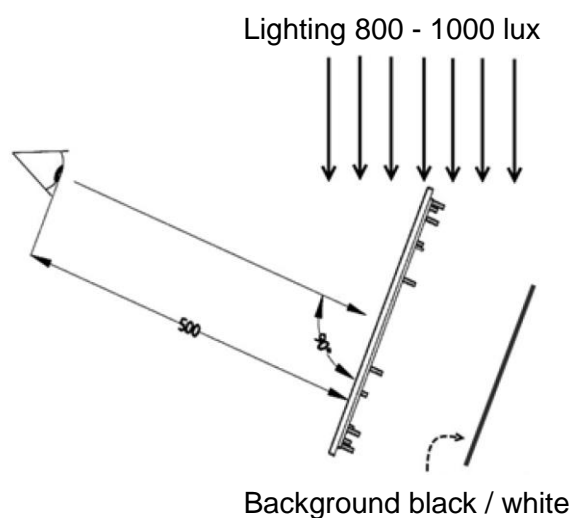

Test setup: Reflexion

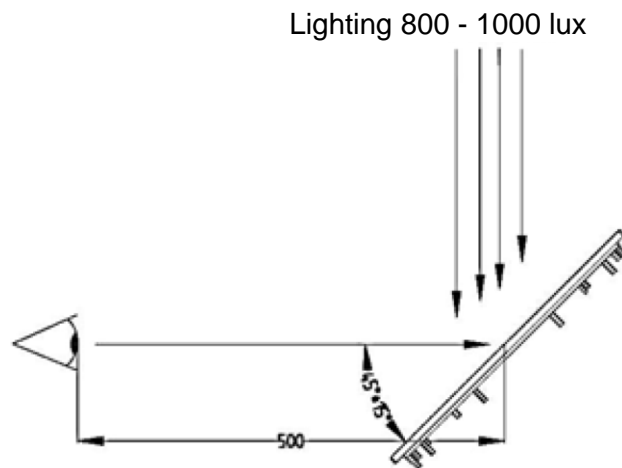

Tester	Trained, experienced person with normal eyesight
Distance tester to tested object	500 mm
Viewing angle (to surface)	
for transmitted light / transmission	90°
for reflexion	30° - 60°
Lighting	Standard, 800 - 1000 lx standard D50 or D65 light
Test light density	Light table with 500 lux

23.3 Optical acceptance of surfaces

This section covers the acceptance criteria applicable to the minimum requirements for surfaces of devices and components.

The values for imperfection types listed under "tolerance limits" do not constitute a defect or an imperfection of the device or component and must therefore be tolerated.

23.3.1 Optical acceptance glass

Imperfection type	Criterion	Tolerance limits
Total imperfections	Number	max. 3
Cleanness of glass surface	Clearly visible dirt	not permitted
Edge crack / incipient crack	Visible	not permitted
Scratches	Width	up to 0.16 mm
	Length	up to 40 mm
	Cumulative length of all scratches	max. 40 mm
	Long side of glass < 300 mm, distance > 70 mm	
	Number	2
	Long side of glass 300 - 600 mm, distance > 70 mm	
	Number	3
Hairline scratches / scraper damage	Width	max. 0.05 mm
	Length	max. 40 mm
Large point defects	Size	max. 0.4 mm ²
	Number	2
Small point defects	Size	max. 0.16 - 0.4 mm ²
	Number	5
Permitted point defects	Size	< 0.16 mm ² , provided there is no cluster ***
Interference points	Ø < 0.2 mm	Permitted
	0.2 mm < Ø ≤ 0.6 mm	Permitted provided there is no cluster ***
	0.6 mm < Ø ≤ 1.3 mm	5
	1.3 mm < Ø ≤ 2.0 mm	2
	Ø > 2.0 mm	not permitted
Inhomogeneity *	Minor colour variations	Permitted
White haze **	Only visible in reflection	Permitted
	Not visible when device is in operating position.	Permitted



* In the case of coated float glass, inhomogeneity in the form of minor colour variations can occur and cannot be prevented by any technical means.

** Large, cloudy blemish can be more pronounced towards the centre of the glass, but can also affect larger parts of the glass.

*** A cluster is an accumulation of more than 7 disregarded, permitted imperfections that occur within an inspected area of a diameter of 40 mm.

23.3.2 Optical acceptance printing

Description	Tolerance limits
Labelling	Clearly legible, minimum stroke weight 0.3 mm
Characters	Clearly legible
Lines and symbols	Interruptions not permitted
Ink coverage	Sufficient if underlying layers and structures not visible
Acutance	+/- 0.15 mm
Edge blurring	+/- 0.15 mm
Print overlap	Possible colour variations in the overlap area are permitted
Variations of stroke weight	10 %
Within a shaping print	"Fine" as specified in DIN ISO 2768-1 General tolerance class
Between shaping prints	< 400 mm +/- 0.3 mm ≥ 400 mm +/- 0.5 mm

Imperfection type	Criterion	Tolerance limits
Dirt and dust particle inclusions, stains, fluff,	Size	max. 0.16 mm ²
	Size for weak colour contrast	max. 0.25 mm ²
	Number / 100 cm ²	1
	Minimum distance	80 mm
	Lower limit	0.063 mm ²





23.3.3 Optical acceptance, other surfaces

Definitions

Scratch	straight or curved / wavy surface damage
Dents / dings	plastic deformation inwards or outwards
Scuff mark without dent	"punch mark"-type depression

Surface categories

If not specified otherwise in the drawing, the following applies:

A surface	Surface is frequently viewed, typically the front plate. Surface is in customer's field of vision
	Colour code 
B surface	Surface is occasionally viewed, typically the sides of the device
	Colour code 
C surface	Surface is rarely viewed, typically the back or bottom of device
	Colour code 
D surface	Surface is never viewed, typically the inside of the device
	Colour code 

Accessories such as stand, wall bracket etc. are termed C surfaces

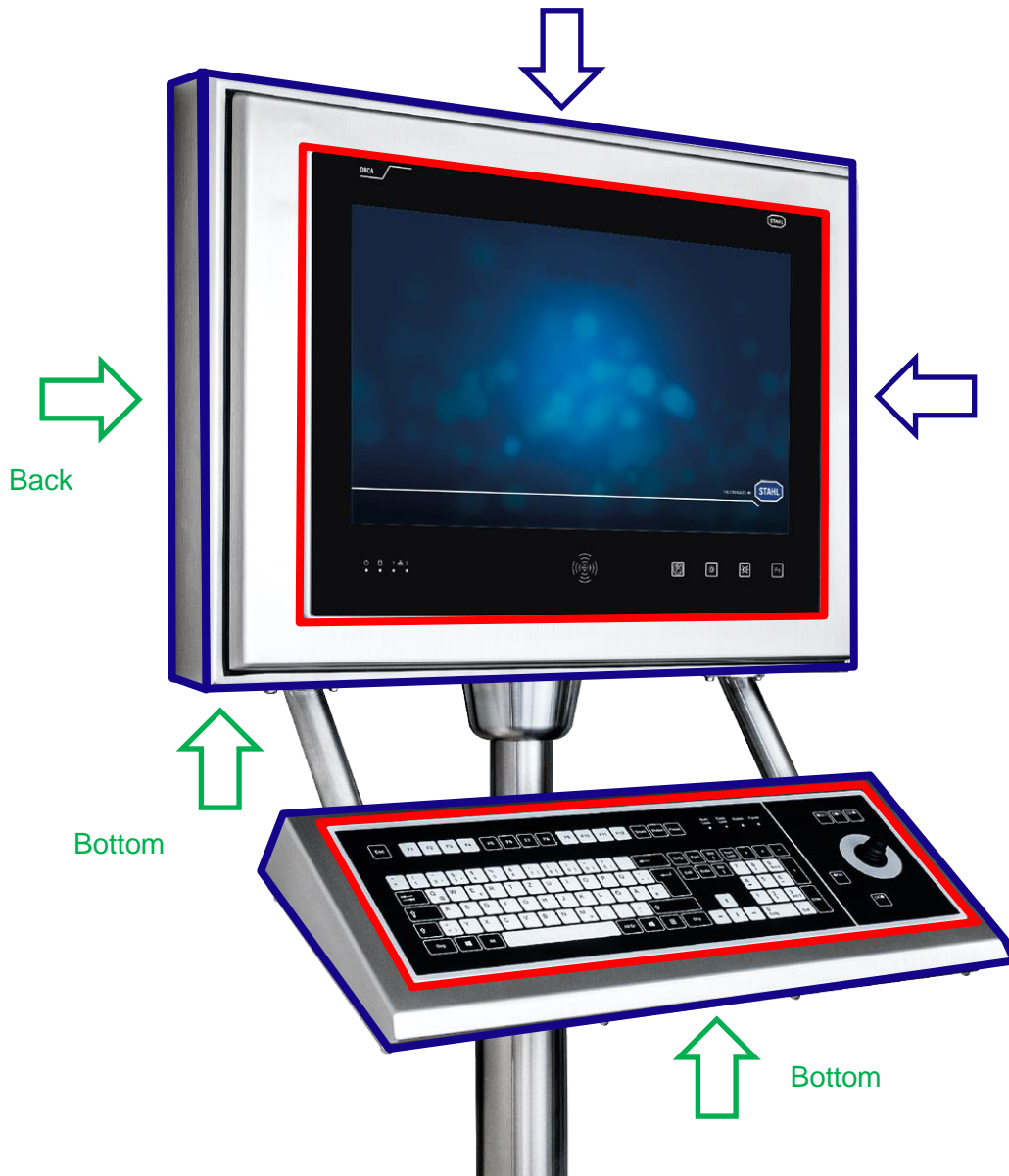

Imperfection type	A surface	B surface	C surface	D surface
Scratches	max. 1 per side	max. 2 per side	1x up to 100 mm with the grain	permitted
	0.05 – 0.1 mm wide and max. 10 mm long	0.05 – 0.1 mm wide and max. 10 mm long		
	or	or	and	
	0.01 – 0.05 mm wide and max. 40 mm long	0.01 – 0.05 mm wide and max. 40 mm long	3x up to 15 mm against the grain	
	only with the grain	only with the grain	1x up to 30 mm against the grain	
Gouges, depressions (punch-mark-type depression)	not permitted	not permitted	max. 2 per side max. 0.3 mm wide max. 3 mm long	permitted
Dents / cavities	not permitted	not permitted	not permitted	not permitted
Welding flaws	not permitted	not permitted	not permitted	not permitted
Chatter marks	not permitted	not permitted	not permitted	not permitted
Material flaws	not permitted	not permitted	not permitted	not permitted
Orange peel: surface not homogeneous	not permitted	not permitted	not permitted	permitted

24 Appendix H

24.1 Control Drawing

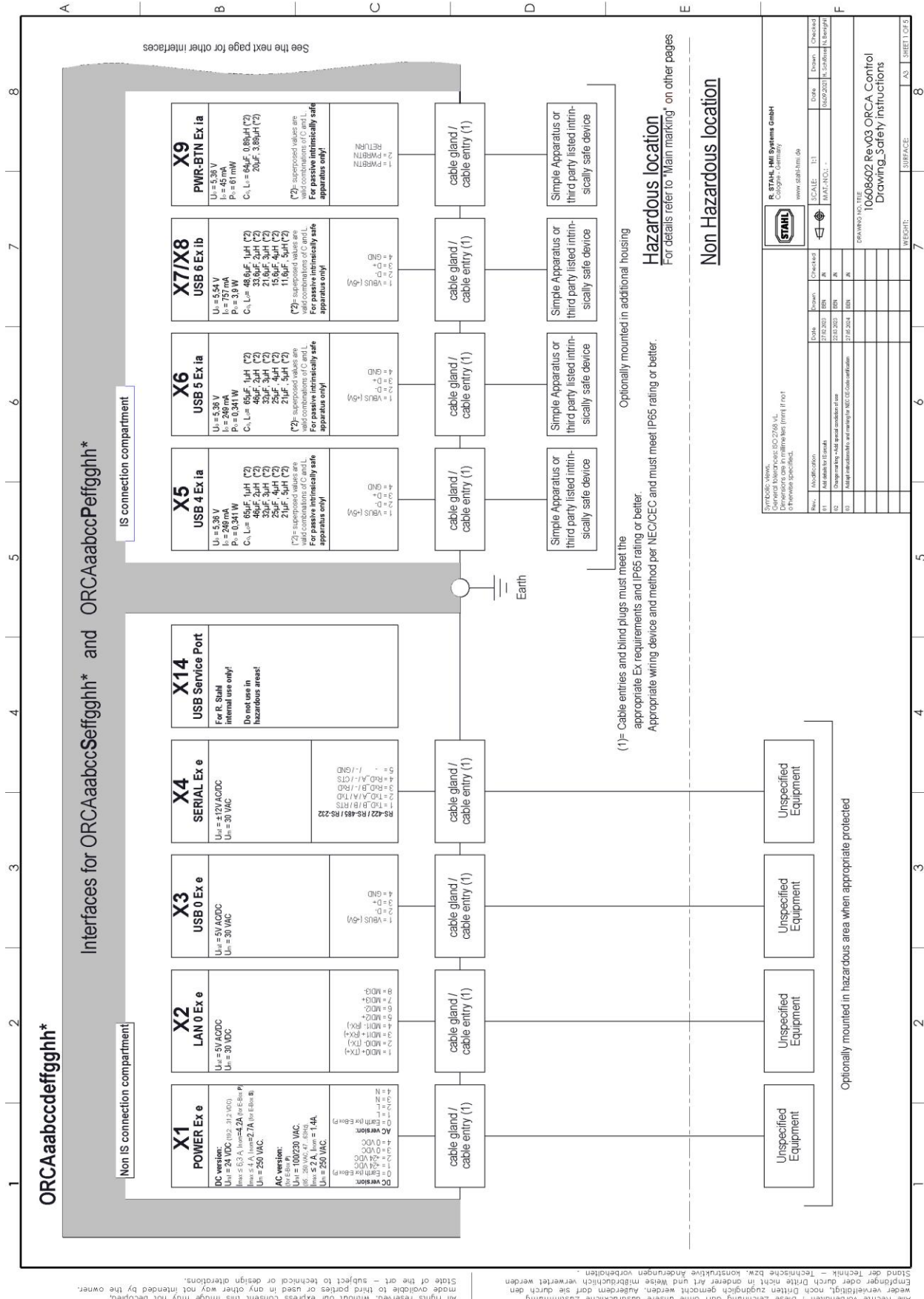

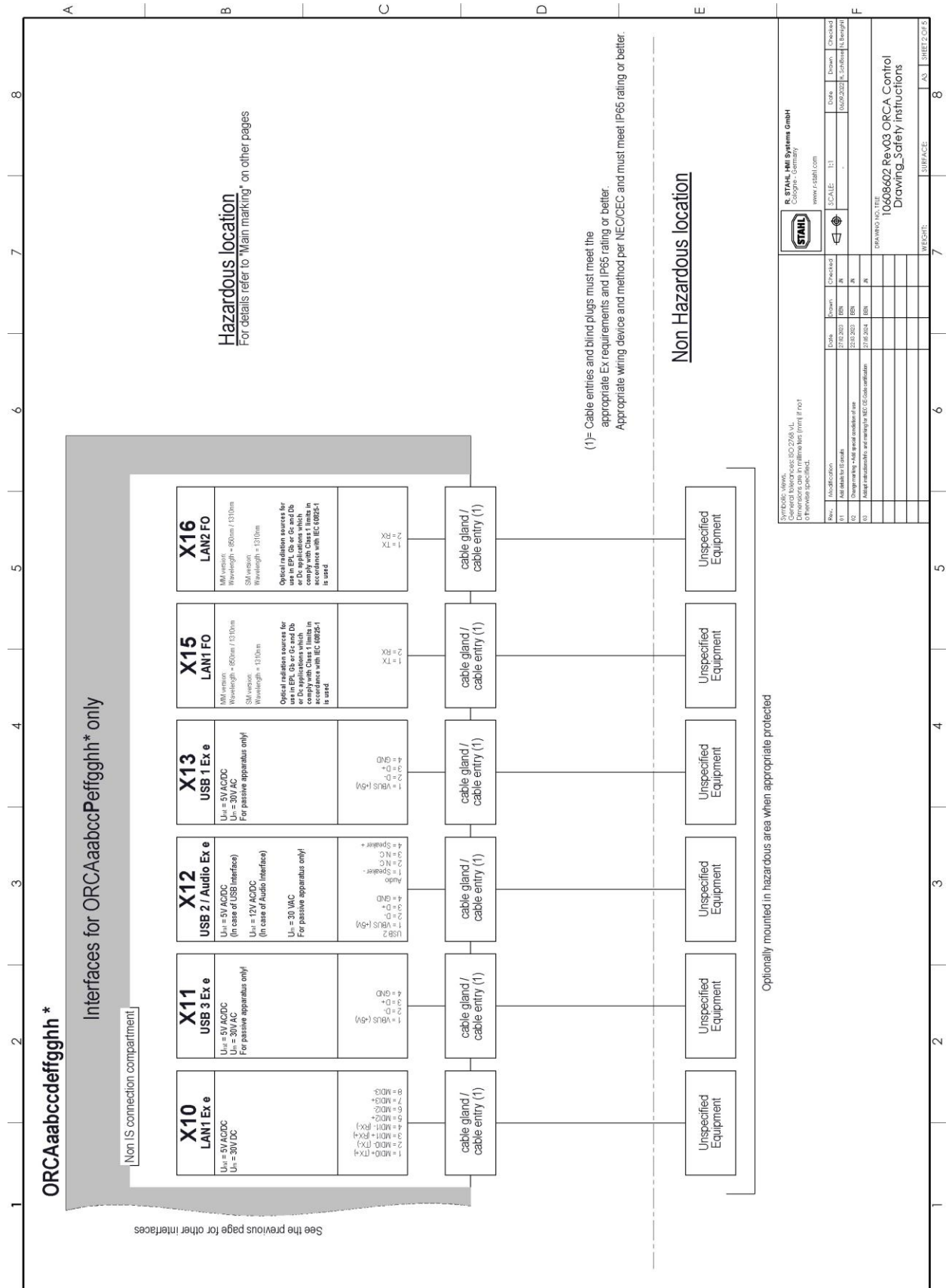

Details and instructions:

- The ORCA is an explosion-protected device for installation in hazardous areas and can be operated in areas as noted on the device.
- The ORCA may only be installed and operated in an undamaged, dry and clean condition! Any damage may compromise the explosion protection!
- The national assembly and installation rules and the generally accepted technical rules must be observed. The device and its accessories must be connected and operated according to applicable standards, directives and installation guidelines. Only qualified personnel that has been instructed accordingly, are allowed to install the device.
- The intrinsically safe circuits do not satisfy the 500 V dielectric with respect to earth. The GND of intrinsically safe circuits are connected to earth.
- Copper cables (solid or flexible) for field wiring at terminal blocks X1, X2, X3, X4, X5, X6, X7, X9, X10, X11, X12 and X13 may be used with the cross sections between 0.2 mm² (AWG24) and 2.5 mm² (AWG14).
- Two conductors with the same cross section and conductor type) with the cross sections between 0.2mm² (AWG24) and 0.75 mm² (AWG18) may be used also.
- Conductor cross section flexible with ferrule with or without plastic sleeve between 0.25mm² (AWG24) and 1.5mm² (AWG16). Stripping length 9mm.
- Two conductors with same cross section, stranded, with ferrule without plastic sleeve.
- The terminal blocks require a tightening torque of 0.4 Nm ... 0.5 Nm.
- Cable glands or other equipment (e.g. cable connector, buttons...) used in the threads of the connection compartment, must be suitable and certified for the area of installation and adjusted if necessary. Herewith possible changing of the ambient parameters e.g. like ambient temperature range must be observed. Thread sizes E-Box P: 1x M25x1.5, 3x M20x1.5, 7x M16x1.5, E-Box S: 2x M20x1.5, 5x M16x1.5. Optional pre mounted cable glands suitable for cable diameter range M25 = 14 ... 18mm, M20 = 6, 12mm, M16 = 4, 8 mm. The lightning torques for the cable glands may vary depending on the cables and wires used. The users have to determine and apply the required torques themselves. Optional pre mounted cable glands for use with non-armored cables. Not used cable glands must be closed with suitable blind plugs or replaced by suitable blind plugs.
- The device has to be installed in such a way that mechanical effects (pulling forces) on the cables are excluded. The cable has to be fixed and effectively protected against damage.
- For ATEX/IECEx: Only permanently laid cables may be connected to the optional pre-mounted cable glands.
- The temperature rating of the cables and cable entries to be used must be appropriate for the ambient temperature of the installation:
For: -20 °C < Ta ≤ +50 °C: cables and cable gland/entries approved for at least 70 °C
For: +30 °C < Ta ≤ +55 °C: cables and cable gland/entries approved for at least 95 °C
- This associated apparatus may also be connected to simple apparatus as defined in the National Electrical Code (ANSI/NFPA 70), or other local codes, as applicable.
- Intrinsically safe circuits must be wired and separated in accordance with Article 504.20 of the National Electrical Code (ANSI/NFPA 70) or other local codes, as applicable.
- Cable glands for use with non-armored cables. Cable glands used must be suitable and certified for the area of installation and adjusted if necessary. Not used cable glands must be closed with suitable blind plugs. When installed with cable, this device shall be installed in areas where the cables has been deemed suitable for the locals as defined in the NEC®/CE Code.
- **FOR USA:** All circuits must be wired using the National Electric Code NFPA 70 or other local codes for installation within the United States.
- **FOR Canada:** All circuits must be wired as specified in the Canadian Electric Code or other local codes for installation within Canada.
- The following special conditions of use are actually listed on the certificates of the following accessories, they must be taken into account if they are installed with ORCA:
 - The Hummel AG cable glands Series HSK-K-MZ-Ex were tested for low risk of mechanical danger and shall be protected against higher impact energy levels.
 - The CMP-Products Type 737 non-metallic adaptors or reducers shall only be used with non-metallic cable glands.

Alle Rechte vorbehalten. Diese Zeichnung darf ohne unsere ausdrückliche Zustimmung Empfänger oder durch Dritte nicht in anderer Art und Weise missbräuchlich verwendet werden. Weder vervielfältigt, noch Dritten zugänglich gemacht werden, außerdem darf sie durch den Stand der Technik – Technische Änderungen vorbehalten.

All rights reserved. Without our express consent this image may not be copied, note available or used in any way not intended by the owner.

Stole of the art - subject to technical or design alterations.

A	B	C	D	E	F
1	2	3	4	5	6
6	7	8	9	10	11

- The earth / ground (equipotential bonding) connector at the back of the ORCA E-Box must be connected to the equipotential bonding conductor of the hazardous area. The earth cable must have a minimum cross section of 4 mm² and be fitted properly.
- The internal grounding terminal shall be used for the equipment grounding connection and the external terminal is for supplementary bonding connection where local codes or authorities permit or require such connection.
- A rating of 250V / 17A must be ensured at place of installation.
- For ORCA01M only: The equipment is intended for installation in an area providing at least pollution degree 2, as defined in IEC 60664-1.
- Transient protection shall be provided that is set at a level not exceeding 140% of the peak rated voltage value at the supply terminals to the equipment.
- Ambient rating: -20°C ≤ Ta ≤ +55°C at place of installation. Rel. humidity 90% at 40 °C without condensation. Altitude up to 2000m. Outdoor use: 1 type of protection IP65. The device may be installed and operated in any position.
- Panel mount: Put device through cut out matching to D-Box size. Slide mounting frame from rear side over ORCA and fix with mounting screws (torque 3.5 - 7.5 Nm) like shown at control drawing
- The devices are suitable for installation into the cutout of an enclosure with IP65 according to IEC 60079-0 resp. into the cutout of an enclosure type of protection Ex eb resp. ec or Ex tb resp. tc or Ex p. They fulfil the respective enclosure requirements.
- Torque for connection compartment screws: 3.5 - 7.5 Nm. Torque to mount E-Box and D-Box together (for service purposes): 3.5 - 7.5 Nm.
- Only appropriate tools must be used for the installation.
- If the equipment is used in a manner not specified by the manufacturer, the protection provided by the equipment may be impaired.
- Keep unit free of decontaminations. Use suitable cleaning agents for cleaning. Do not use aggressive or abrasive agents.
- System maintenance should focus on the following: Seal wear. Damage to front screen / glass. All screws are tightened properly. All cables and lines are properly connected and undamaged.
- Any repairs must always be carried out by the manufacturer.
- For ORCA "AC" models:
Overvoltage category II according to IEC 60664- 1.
A disconnecting device, such as a switch or circuit breaker, must be included in the installation. It must be located in an appropriate and easily accessible place and must be marked as the disconnecting device for the equipment. Additionally, it shall disconnect all current-carrying conductors and must not interrupt a protective earth conductor.

Environmental conditions for installation regarding NEC® / CE Code:

- Indoor use dry location. Or, outdoor use when mounted on type 3X or better enclosure.
- Pollution Degree 2 according to IEC 60664- 1 or mounted on type 3X or better enclosure.

R. STAHL HMI Systems GmbH Control Systems Caspary - Germany www.stahl-hmi.de			
Symbol: www.stahl-hmi.de General Information: 350 2768 - 44 Drawing title: 10608602 Rev03 ORCA Control Drawing_Safety instructions Drawing scale: 1:1 Drawing date: 03.08.2024			
Rev.:	Description:	Date:	Checked:
01	Initial release for service	27.02.2022	EBN
02	Change marking - Add special condition of use	23.03.2022	EBN
03	Added construction data and marking for NEC/CE code compliance	27.08.2024	EBN
DRAWING NO. TITLE 10608602 Rev03 ORCA Control Drawing_Safety instructions			
SHEET NO.		SHEET	
AS		8	

<p>WARNING:</p> <ul style="list-style-type: none"> - Do not open when an explosive atmosphere is present! - After de-energizing, delay 20 minutes before opening. - Potential electrostatic charging hazard - Clean only with damp cloth! - Do not open! This enclosure has been permanently sealed and cannot be repaired. - Ne pas ouvrir en présence d'une atmosphère explosive! - Après mise hors tension, attendre 20 minutes avant l'ouverture. - Danger potentiel de charges électrostatiques. Nettoyer uniquement avec un tissu humide! - Ne pas ouvrir! Ce conteneur est scellé de façon permanente et ne peut pas être réparé. - Do not open connection compartment when energized. - The device must be de-energized before the E-Box and D-Box will be separated for service purposes. - For AC models: The disconnection shall disconnect all current-carrying conductors and shall not interrupt a protective earth conductor. 	<p>Family code:</p> <p>The HMI series ORCA is available in different variants.</p> <p>ORCAaabbccdefggghh*</p> <p>a = Revision 01=Revision 01</p> <p>b = Zone E=Zone 1 / 21 (EPL Gb / Db) M=Zone 2 / 22 (EPL Gc / Dc)</p> <p>cc = Technology 00=None TC=Technology Thin Client / Panel PC DM=Technology Direct Monitor</p> <p>d = E-Box 0=None S=Standard P=Pro</p> <p>e = D-Box 0=None 3=Size 3 4=Size 4 6=Size 6</p> <p>ff = Power 00=None AC=AC Power DC=DC Power</p> <p>gg = Fiber Optic 00=None MM=MM SM=SM</p> <p>hh = RFID 00=None C0=RFID Crypt C6=RFID ASC C8=RFID PC-SC</p> <p>* = any alphanumeric or symbolic characters, without relevance for explosion protection</p>	<p>Main marking:</p> <p>Install in accordance with Control Drawing 10608602 R_STAHL_HMI_Systems_GmbH, Cologne / Germany -20°C ≤ Ta ≤ +55°C, IP65,</p> <p>For ORCA01E.... :</p> <p>ATEX: UL 23 ATEX 2902X C60158 II 2(1) D Ex eb I b [ib] Ia Ga] IIC T4 Gb IECEX: IECEx UL 23 0007X Ex eb I b [ib] Ia Ga] IIC T4 Gb Ex tb [tb] Ia Da] IIC T115°C Db</p> <p>IND. CONT. EQ. FOR HAZ. LOC</p> <p>UL ZONE MARKINGS CLASS I, Zone 1, AEx eb I b [ib] Ia Ga] IIC T4 Gb Zone 21, AEx tb [tb] Ia Da] IIC T115°C Db</p> <p>C-UL ZONE MARKINGS Ex eb I b [ib] Ia Ga] IIC T4 Gb X Zone 21, Ex tb [tb] Ia Da] IIC T115°C Db X</p> <p>UL and C-UL DIVISION EQUIVALENCY MARKINGS CLASS I, DIVISION 2, GROUPS A,B,C,D T4 CLASS II, DIVISION 2, GROUPS F,G,T4 CLASS III, DIVISION 2 Enclosure Type 4X when mounted in suitable Type 4X enclosure.</p> <p>For ORCA01M.... :</p> <p>ATEX: UL 23 ATEX 2902X C60158 II 3(1) G Ex ec I b [ib] Ia Ga] IIC T4 Gc IECEX: IECEx UL 23 0007X Ex ec I b [ib] Ia Ga] IIC T4 Gc Ex tc I b [ib] Ia Da] IIC T115°C Dc</p> <p>IND. CONT. EQ. FOR HAZ. LOC</p> <p>UL ZONE MARKINGS CLASS I, Zone 2, AEx ec I b [ib] Ia Ga] IIC T4 Gc Zone 22, AEx tc I b [ib] Ia Da] IIB T115°C Dc</p> <p>C-UL ZONE MARKINGS Ex ec I b [ib] Ia Ga] IIC T4 Gc X Zone 22, Ex tc I b [ib] Ia Da] IIC T115°C Dc X</p> <p>UL and C-UL DIVISION EQUIVALENCY MARKINGS CLASS I, DIVISION 2, GROUPS A,B,C,D T4 CLASS II, DIVISION 2, GROUPS F,G,T4 CLASS III, DIVISION 2 Enclosure Type 4X when mounted in suitable Type 4X enclosure.</p>	<p>Specific conditions of use: YES as shown: (see certificate)</p> <ul style="list-style-type: none"> - The devices (inclusive connection cables) shall only be installed in areas where intensive electrostatic charging processes are excluded. - The intrinsically safe circuits are connected to earth. Along the intrinsically safe circuits, potential equalization must exist or the intrinsically safe apparatus connected must meet the 500 V r.m.s dielectric strength test between circuit and the frame. - Maximum overvoltage category II according to IEC 60684-1 is permitted for the non-intrinsically safe circuits. - The special conditions of use and the operating instructions for cable entries, blind plugs and adapters located in connection compartment must be taken into account. <p>For ORCA01M... only:</p> <p>The equipment is intended for installation in an area providing at least pollution degree 2 as defined in IEC 60684-1. Transient protection shall be provided that is set at a level not exceeding 140 % of the peak rated voltage value at the supply terminals to the equipment.</p>	<p>List of standards:</p> <p>See certificate.</p>
<p>UL LISTED E202379</p> <p>UL LISTED E202379</p>	<p>UL LISTED E202379</p> <p>UL LISTED E202379</p>	<p>UL LISTED E202379</p> <p>UL LISTED E202379</p>	<p>UL LISTED E202379</p> <p>UL LISTED E202379</p>	<p>UL LISTED E202379</p> <p>UL LISTED E202379</p>

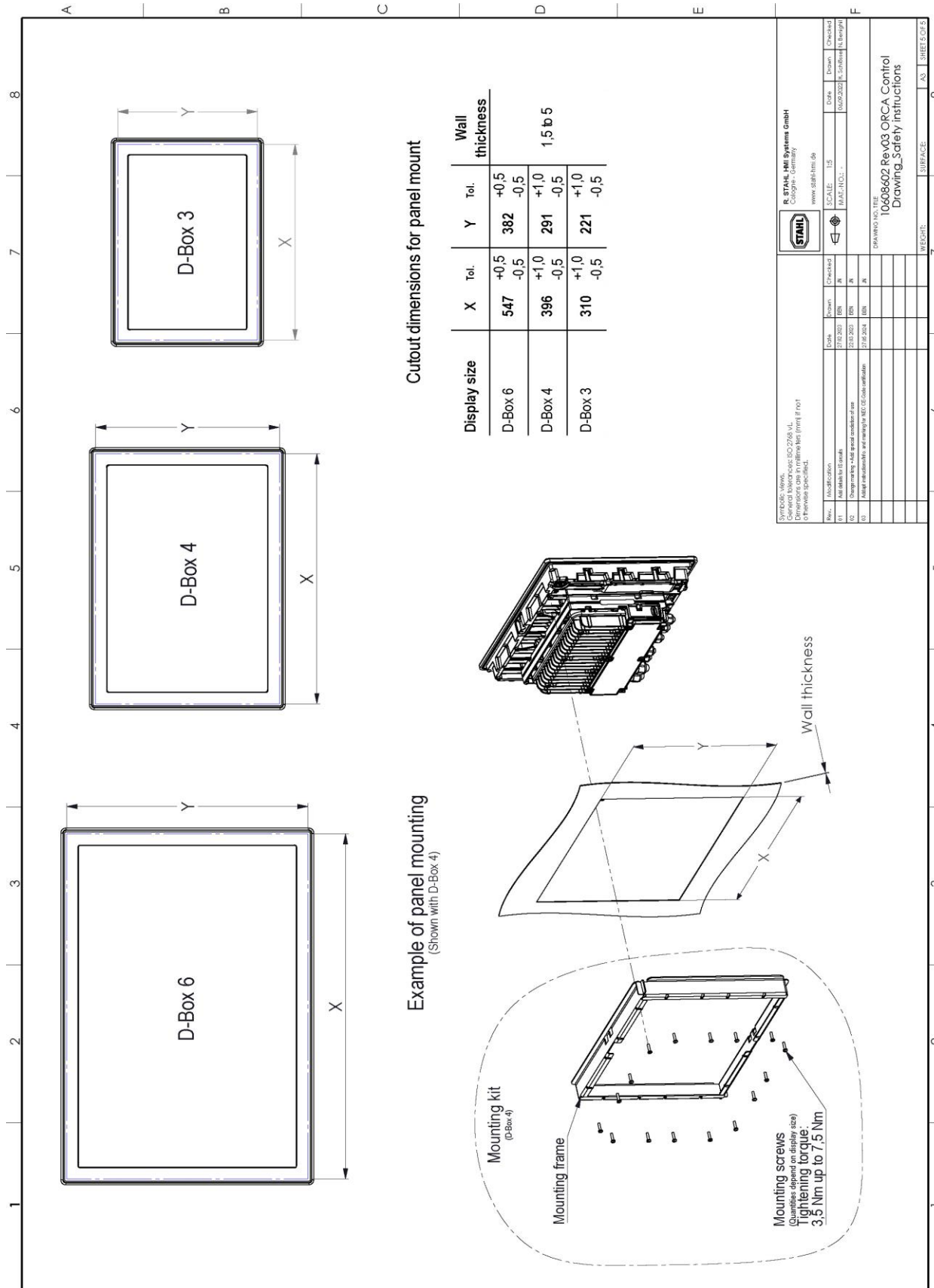

Alle Rechte vorbehalten | Diese Zeichnung darf ohne unsere ausdrückliche Zustimmung weder ververvielt, noch Dritten zugänglich gemacht werden, außerdem darf sie durch den Empfänger oder durch Dritte nicht in anderer Art und Weise mibrauchlich verwendet werden. Stand der Technik - Technische bzw. konstruktive Änderungen vorbehalten.

All rights reserved. Without our express consent this image may not be copied, made available to third parties or used in any other way not intended by the owner.

24.2 Installation Instructions Requirements China

24.2.1 ORCA01E*

安装使用要求
Installation Instructions
Requirements



认证编号
Certification No. CN2024C2309-000334

本产品经认证符合 CNCA-C23-01: 2024 《强制性产品认证实施规则 防爆电气》的要求。
The product(s) is verified and certified according to CNCA-C23-01: 2024 China Compulsory Certification Implementation Rule on Explosion Protected Electrical Product.

#	产品名称 Product 型号 Type	防爆标志 Ex Marking
1	操作终端 ORCA01Eccdeffgghh*	Ex eb ib qb [ib] [ia Ga] IIC T4 Gb Ex tb [ib] [ia Da] IIIC T115°C Db

依据标准 Series standards	GB/T3836.1-2021, GB/T3836.3-2021, GB/T3836.4-2021, GB/T3836.7-2017, GB/T3836.31-2021
安全使用条件 Specific conditions of safety use:	<ul style="list-style-type: none"> - 外壳防护等级: IP65。 - 使用环境温度: -20°C~+55°C。 - 警告-潜在静电电荷危险, 请仅用湿布擦拭外壳表面, 见产品使用说明书。 - 本产品(包括连接电缆)只能安装在不存在密集静电充电过程的区域。 - 本安电路接地; 沿本安电路, 必须有等电位连接, 或者所连接的本安设备必须满足电路与地之间500 V r.m.s 的介电强度测试。 - 根据GB/T16935.1, 非本安电路允许的最大过电压类别为 II类。 - 本产品安装使用时, 应配用已获得CCC认证且适合使用条件的电缆引入装置和/或堵头, 并正确安装。 - Ingress Protection: IP65. - Ambient temperature: -20°C~+55°C. - WARNING - Potential electrostatic charging hazard – Clean only with a damp cloth! See instructions. - The devices (inclusive connection cables) shall only be installed in areas where intensive electrostatic charging processes are excluded.

	<ul style="list-style-type: none"> - The intrinsically safe circuits are connected to earth. Along the intrinsically safe circuits, potential equalization must exist or the intrinsically safe apparatus connected must meet the 500 V r.m.s dielectric strength test between circuit and the frame. - Maximum over voltage category II according to GB/T16935.1 is permitted for the non-intrinsically safe circuits. - Before application, CCC certified cable gland that suitable for the conditions of use and/or stopping plug shall be applied, and correctly installed.
--	--

R. STAHL HMI Systems GmbH

产品上的符合性标志:

Compliance marks on product:



中国强制性认证
China Compulsory Certification

Doc No.: 2022 41 7000 0
Approved: 2024-06-03

24.2.2 ORCA01M*

安装使用要求
Installation Instructions
Requirements



认证编号
Certification No. CN2024C2309-000335

本产品经认证符合 CNCA-C23-01: 2024 《强制性产品认证实施规则 防爆电气》的要求。
The product(s) is verified and certified according to CNCA-C23-01: 2024 China Compulsory Certification Implementation Rule on Explosion Protected Electrical Product.

#	产品名称 Product 型号 Type	防爆标志 Ex Marking
1	操作终端 ORCA01Mccdeffgghh*	Ex ec ib qb [ib] [ia Ga] IIC T4 Gc Ex tc [ib] [ia Da] IIIC T115°C Dc

依据标准 Series standards	GB/T3836.1-2021, GB/T3836.3-2021, GB/T3836.4-2021, GB/T3836.7-2017, GB/T3836.31-2021
安全使用条件 Specific conditions of safety use:	<ul style="list-style-type: none"> - 外壳防护等级: IP65。 - 使用环境温度: -20°C~+55°C。 - 警告-潜在静电电荷危险, 请仅用湿布擦拭外壳表面, 见产品使用说明书。 - 根据GB/T 16935.1, 该设备只应在污染程度不低于2级的区域使用。瞬态保护应提供不超过设备的供电端子额定峰值电压值140%的保护。 - 本产品(包括连接电缆)只能安装在不存在密集静电充电过程的区域。 - 本安电路接地; 沿本安电路, 必须有等电位连接, 或者所连接的本安设备必须满足电路与地之间500 V r.m.s 的介电强度测试。 - 根据GB/T16935.1, 非本安电路允许的最大过电压类别为 II类。 - 本产品安装使用时, 应配用已获得CCC认证且适合使用条件的电缆引入装置和/或堵头, 并正确安装。 - Ingress Protection: IP65. - Ambient temperature: -20°C~+55°C. - WARNING - Potential electrostatic charging hazard – Clean only with a damp cloth! See instructions.

	<ul style="list-style-type: none"> - The devices (inclusive connection cables) shall only be installed in areas where intensive electrostatic charging processes are excluded. - The equipment is intended for installation in an area providing at least pollution degree 2 as defined within GB/T 16935.1. Transient protection shall be provided that is set at a level not exceeding 140 % of the peak rated voltage value at the supply terminals to the equipment. - The devices (inclusive connection cables) shall only be installed in areas where intensive electrostatic charging processes are excluded. - The intrinsically safe circuits are connected to earth. Along the intrinsically safe circuits, potential equalization must exist or the intrinsically safe apparatus connected must meet the 500 V r.m.s dielectric strength test between circuit and the frame. - Maximum over voltage category II according to GB/T16935.1 is permitted for the non-intrinsically safe circuits. - Before application, CCC certified cable gland that suitable for the conditions of use and/or stopping plug shall be applied, and correctly installed.
--	---

R. STAHL HMI Systems GmbH

产品上的符合性标志:

Compliance marks on product:



中国强制性认证
China Compulsory Certification

Doc No.: 2022 41 7000 0
Approved: 2024-06-03

25 Appendix I

25.1 Declarations of conformity

25.1.1 EU

25.1.1.1 ORCA01E*

EU Konformitätserklärung EU Declaration of Conformity Déclaration de Conformité UE



R. STAHL HMI Systems GmbH • Adolf-Grimme-Allee 8 • 50829 Köln, Germany
erklärt in alleiniger Verantwortung, declares in ist sole responsibility, déclare sous sa seule responsabilité,

dass das Produkt: **Bedien- und Beobachtungsgeräte**
that the product: **Operating and Monitoring Devices**
que le produit: **Moniteur de commande et de visualisation**

Typ(en), type(s), type(s): **ORCA01ETCS3..., ORCA01ETCP3 ...**
ORCA01ETCS4..., ORCA01ETCP4 ...
ORCA01ETCS6..., ORCA01ETCP6 ...

mit den Anforderungen der folgenden Richtlinien und Normen übereinstimmt.
is in conformity with the requirements of the following directives and standards.
est conforme aux exigences des directives et des normes suivantes.

Richtlinie(n) / Directive(s) / Directive(s)	Norm(en) / Standard(s) / Norme(s)
2014/34/EU ATEX-Richtlinie 2014/34/EU ATEX Directive 2014/34/UE Directive ATEX <i>Official Journal of the EU L96, 29/03/2014, p. 309–356</i>	EN IEC 60079-0:2018 EN 60079-5:2015 EN IEC 60079-7: 2015 + A1:2018 EN 60079-11:2012 EN 60079-31:2014
Kennzeichnung, marking, marquage:	II 2(1) G Ex eb ib qb [ib] [Ia Ga] IIC T4 Gb II 2(1) D Ex tb [ib] [Ia Da] IIIC T115°C Db
EU Baumusterprüfbescheinigung: EU Type Examination Certificate: Attestation d'examen UE de type:	UL 23 ATEX 2902X (UL International Demko A/S Borupvang 5A, 2750 Ballerup, Denmark NB 0539)
2014/35/EU Niederspannungsrichtlinie: 2014/35/EU Low Voltage Directive: 2014/35/UE Directive Basse Tension: <i>Official Journal of the EU L96, 29/03/2014, p. 357–374</i>	EN 62368-1 : 2014 + AC : 2015
2014/30/EU EMV-Richtlinie 2014/30/EU EMC Directive 2014/30/UE Directive CEM <i>Official Journal of the EU L96, 29/03/2014, p. 79–106</i>	EN 61000-3-2 : 2014 EN 61000-3-3 : 2013 EN 61000-6-2 : 2005 + AC : 2005 EN 61000-6-3 : 2007 + A1 : 2011 + AC : 2012 EN 61000-6-4 : 2007 + A1 : 2011 EN 55035 : 2017 EN 55032 : 2015
2014/53/EU Funkanlagen-Richtlinie 2014/53/EU Radio Equipment Directive 2014/53/UE Directive Équipement Radioélectrique <i>Official Journal of the EU L153, 22/05/2014, p. 62–106</i>	ETSI EN 301489-1 V2.2.3 : 2019-11 ETSI EN 301489-3 V2.1.1 : 2019-01 ETSI EN 300330 V2.1.1 : 2017-02
2011/65/EU RoHS-Richtlinie 2011/65/EU RoHS Directive 2011/65/UE Directive RoHS <i>Official Journal of the EU L174, 1/07/2011, p. 88–110</i>	EN IEC 63000:2018

Für spezifische Merkmale und Bedingungen siehe Betriebsanleitung.
For specific characteristics and conditions see operating instructions.
Pour les caractéristiques et conditions spécifiques, voir le mode d'emploi.

Unterschiedet für und im Namen von: / signed for and on behalf of: / signé pour et au nom de:
R. STAHL HMI Systems GmbH

Köln, 2023-05-15

i.V.

Alexander Jung
Director R&D

i.V.

Nabil Benighil
Head of Certification

Ort und Datum
Place and date
Lieu et date

25.1.1.2 ORCA01M*

EU Konformitätserklärung
EU Declaration of Conformity
Déclaration de Conformité UE



R. STAHL HMI Systems GmbH • Adolf-Grimme-Allee 8 • 50829 Köln, Germany
 erklärt in alleiniger Verantwortung, declares in ist sole responsibility, déclare sous sa seule responsabilité,

dass das Produkt: **Bedien- und Beobachtungsgeräte**
that the product: *Operating and Monitoring Devices*
que le produit: *Moniteur de commande et de visualisation*

Typ(en), type(s), type(s): ORCA01MTC3..., ORCA01MTC3 ...
 ORCA01MTC4..., ORCA01MTC4 ...
 ORCA01MTC6..., ORCA01MTC6 ...

mit den Anforderungen der folgenden Richtlinien und Normen übereinstimmt.
 is in conformity with the requirements of the following directives and standards.
 est conforme aux exigences des directives et des normes suivantes.

Richtlinie(n) / Directive(s) / Directive(s)	Norm(en) / Standard(s) / Norme(s)
2014/34/EU ATEX-Richtlinie 2014/34/EU ATEX Directive 2014/34/UE Directive ATEX Official Journal of the EU L96, 29/03/2014, p. 309–356	EN IEC 60079-0:2018 EN 60079-5:2015 EN IEC 60079-7: 2015 + A1:2018 EN 60079-11:2012 EN 60079-31:2014
Kennzeichnung, <i>marking, marquage:</i>	II 3(1) G Ex ec ib qb [ib] [ia Ga] IIC T4 Gc II 3(1) D Ex tc [ib] [ia Da] IIC T115°C Dc
EU Baumusterprüfbescheinigung: <i>EU Type Examination Certificate:</i> <i>Attestation d'examen UE de type:</i>	UL 23 ATEX 2902X (UL International Demko A/S Borupvang 5A, 2750 Ballerup, Denmark NB 0539)
2014/35/EU Niederspannungsrichtlinie: 2014/35/EU Low Voltage Directive: 2014/35/UE Directive Basse Tension: Official Journal of the EU L96, 29/03/2014, p. 357–374	EN 62368-1 : 2014 + AC : 2015
2014/30/EU EMV-Richtlinie 2014/30/EU EMC Directive 2014/30/UE Directive CEM Official Journal of the EU L96, 29/03/2014, p. 79–106	EN 61000-3-2 : 2014 EN 61000-3-3 : 2013 EN 61000-6-2 : 2005 + AC : 2005 EN 61000-6-3 : 2007 + A1 : 2011 + AC : 2012 EN 61000-6-4 : 2007 + A1 : 2011 EN 55035 : 2017 EN 55032 : 2015
2014/53/EU Funkanlagen-Richtlinie 2014/53/EU Radio Equipment Directive 2014/53/UE Directive Équipement Radioélectrique Official Journal of the EU L153, 22/05/2014, p. 62–106	ETSI EN 301489-1 V2.2.3 : 2019-11 ETSI EN 301489-3 V2.1.1 : 2019-01 ETSI EN 300330 V2.1.1 : 2017-02
2011/65/EU RoHS-Richtlinie 2011/65/EU RoHS Directive 2011/65/UE Directive RoHS Official Journal of the EU L174, 1/07/2011, p. 88–110	EN IEC 63000:2018

Für spezifische Merkmale und Bedingungen siehe Betriebsanleitung.
 For specific characteristics and conditions see operating instructions.
 Pour les caractéristiques et conditions spécifiques, voir le mode d'emploi.

Unterszeichnet für und im Namen von: / signed for and on behalf of: / signé pour et au nom de:
R. STAHL HMI Systems GmbH

Köln, 2023-05-15

i.V.

Alexander Jung
 Director R&D

i.V.

Nabil Benighil
 Head of Certification

Ort und Datum
Place and date
Lieu et date

25.1.2 USA UL



Certificate of Compliance

Certificate Number:

UL-US-2421615-0

Report Reference:

E202379-20240607

Issue Date:

2024-06-20

Issued to:

R. STAHL HMI Systems GmbH
Adolf-Grimme-Allee 8 Koeln 50829 Germany

This certificate confirms that representative samples of:
NWGD - Programmable Controllers for Use in Zone Classified Hazardous Locations

See Addendum Page for Product Designation(s).

Have been evaluated by UL in accordance with the Standard(s) indicated on this Certificate.

UL 60079-0, Edition 7, Issued 2019-03-26, Revised 2020-04-15, UL 60079-5, Edition 4, Issued 2016-04-29, Revised 2020-08-14, UL 60079-7, Edition 5, Issued 2017-02-24, Revised 2021-06-03, UL 60079-11, Edition: 6, Issue Date: 2013-02-15, Revision Date: 2023-01-25, UL 60079-31, Edition: 2, Issue Date: 2015-6-12, Revision Date: 2020-8-13, UL 61010-1, 3rd Ed., Issue Date: 2012-05-11, Revision Date: 2023-06-06, UL 61010-2-201, 2nd Ed., Issue Date: 2018-05-14

Additional Information:

See UL Product iQ® at <https://iq.ulprospector.com> for additional information.

This Certificate of Compliance indicates that representative samples of the product described in the certification report have met the requirements for UL certification. It does not provide authorization to apply the UL Mark. Only the Authorization Page that references the Follow-Up Services Procedure for ongoing surveillance provides authorization to apply the UL Mark.

Only those products bearing the UL Mark should be considered as being UL Certified and covered under UL's Follow-Up Services.

Look for the UL Certification Mark on the product.



David Piecuch
 UL Mark Certification Program Manager



Any information and documentation involving UL Mark services are provided on behalf of UL LLC (UL) or any authorized licensee of UL. For questions, please contact UL Solutions Customer Service at <https://www.ul.com/contact-us>

CERTIFICATE OF COMPLIANCE

Certificate number UL-US-2421615-0
Report reference E202379-20240607
Date 2024-06-20

This is to certify that representative samples of the product as specified on this certificate were tested according to the current UL requirements.

Model	Product Description
ORCA01E, followed by 00, TC, or DM, followed by 0, S, or P, followed by 0, 3, 4, or 6, followed by 00, AC, or DC, followed by 00, MM, or SM, followed by 00, C5, C6, or C8, and may be followed by additional numbers or characters	Programmable Controllers
ORCA01M, followed by 00, TC, or DM, followed by 0, S, or P, followed by 0, 3, 4, or 6, followed by 00, AC, or DC, followed by 00, MM, or SM, followed by 00, C5, C6, or C8, and may be followed by additional numbers or characters	Programmable Controllers



David Piecuch
 UL Mark Certification Program Manager

Any information and documentation involving UL Mark services are provided on behalf of UL LLC (UL) or any authorized licensee of UL. For questions, please contact UL Solutions Customer Service at <https://www.ul.com/contact-us>



25.1.3 Canada UL



Certificate of Compliance

Certificate Number:

UL-CA-2417306-0

Report Reference:

E202379-20240607

Issue Date:

2024-06-20

Issued to:

R. STAHL HMI Systems GmbH
Adolf-Grimme-Allee 8 Koeln 50829
Germany

This certificate confirms that representative samples of:
NWGD7 - Programmable Controllers for Use in Zone Classified
Hazardous Locations Certified for Canada

See Addendum Page for Product Designation(s).

Have been evaluated by UL in accordance with the Standard(s) indicated on this Certificate.

CSA C22.2 NO. 61010-1, 3rd Ed., Issue Date: 2012-05-11, Revision Date: 2018-11-01, CSA IEC 61010-2-201, Edition 2, Issued 2018-02-01, CSA C22.2 NO. 60079-0:19, 4th Ed., Issue Date: 2019-02-01, CSA C22.2 No. 60079-5, Edition: 2, Issue Date: 2016-10, CSA C22.2 No. 60079-7, Edition 2, AMD 1, Issue Date 2016-10, Revision Date 2018-09, CSA C22.2 NO. 60079-11:14, 2nd Ed., Issue Date: 2014-02-01, CSA C22.2 No. 60079-31, Edition: 2, Issue Date: 2015-10

Additional Information:

See UL Product iQ® at <https://iq.ulprospector.com> for additional information.

This Certificate of Compliance indicates that representative samples of the product described in the certification report have met the requirements for UL certification. It does not provide authorization to apply the UL Mark. Only the Authorization Page that references the Follow-Up Services Procedure for ongoing surveillance provides authorization to apply the UL Mark.

Only those products bearing the UL Mark should be considered as being UL Certified and covered under UL's Follow-Up Services.

Look for the UL Certification Mark on the product.



David Piecuch
 UL Mark Certification Program Manager



Any information and documentation involving UL Mark services are provided on behalf of UL LLC (UL) or any authorized licensee of UL. For questions, please contact UL Solutions Customer Service at <https://www.ul.com/contact-us>

CERTIFICATE OF COMPLIANCE

Certificate number UL-CA-2417306-0
Report reference E202379-20240607
Date 2024-06-20

This is to certify that representative samples of the product as specified on this certificate were tested according to the current UL requirements.

Model	Product Description
ORCA01E, followed by 00, TC, or DM, followed by 0, S, or P, followed by 0, 3, 4, or 6, followed by 00, AC, or DC, followed by 00, MM, or SM, followed by 00, C5, C6, or C8, and may be followed by additional numbers or characters	Programmable Controllers
ORCA01M, followed by 00, TC, or DM, followed by 0, S, or P, followed by 0, 3, 4, or 6, followed by 00, AC, or DC, followed by 00, MM, or SM, followed by 00, C5, C6, or C8, and may be followed by additional numbers or characters	Programmable Controllers

 David Piecuch
 UL Mark Certification Program Manager

Any information and documentation involving UL Mark services are provided on behalf of UL LLC (UL) or any authorized licensee of UL. For questions, please contact UL Solutions Customer Service at <https://www.ul.com/contact-us>



25.1.4 CCC

25.1.4.1 ORCA01E*



CERTIFICATE FOR CHINA COMPULSORY PRODUCT CERTIFICATION

No.: 2024312309000830

Applicant and address
R. STAHL HMI Systems GmbH
Adolf-Grimme-Allee 8, 50829 Köln, Germany

Manufacturer and address
R. STAHL HMI Systems GmbH
Adolf-Grimme-Allee 8, 50829 Köln, Germany

Factory and address
R. STAHL HMI Systems GmbH
Adolf-Grimme-Allee 8, 50829 Köln, Germany

Product, series, specification and model
Operator Terminals
ORCA01Eccdeffggh*

Ex eb ib qb [ib] [ia Ga] IIC T4 Gb, Ex tb [ib] [ia Da] IIIC T115°C Db

Standards
GB/T 3836.1-2021, GB/T 3836.3-2021, GB/T 3836.4-2021, GB/T 3836.7-2017,
GB/T 3836.31-2021

**This product(s) complies with the requirements of CNCA-C23-01: 2024
China Compulsory Certification Implementation Rule on Explosion
Protected Electrical Product.**

Issue date: 2024-06-18 Valid to: 2029-06-17

Detailed information and status of this certificate is available by using the QR code,
visiting CNEx's website or CNCA's website: www.cnca.gov.cn.

This translated document has no legal effect and shall not be used alone.





Director: 

Nanyang Explosion Protected Electrical
Apparatus Research Institute Co.,Ltd.

<http://www.ccc-cnex.com> ccc.china-ex.com Add: No. 20, North Zhongjing Road, Nanyang,
Henan, P. R. China P.C.: 473008 Tel: 0377-63239734
Email: ccc@cn-ex.com



CERTIFICATE FOR CHINA COMPULSORY PRODUCT CERTIFICATION

No.: 2024312309000830

Annex: Page 1 of 10

Product information:

1. This certificate covers the following models:

- ORCA01Eccdeffgghh*

Nomenclature:

ORCA	01	E	cc	d	e	ff	gg	hh	*
	a	b	cc	d	e	ff	gg	hh	*

a: 01= Revision 01

b: E=Zone 1 / 21 (EPL Gb / Db)

cc: Technology

00=None+

TC=Technology Thin Client / Panel PC

DM=Technology Direct Monitor

d: E-Box

0=None+

S=Standard

P=Pro

e: D-Box

0=None+

3=Size 3

4=Size 4

6=Size 6

ff: Power

00=None+



Nanyang Explosion Protected Electrical Apparatus Research Institute Co.,Ltd.



<http://www.ccc-cnex.com>
ccc.china-ex.com

Add: No. 20, North Zhongjing Road, Nanyang,
Henan, P. R. China P.C.: 473008

Tel: 0377-63239734
Email: ccc@cn-ex.com



CERTIFICATE FOR CHINA COMPULSORY PRODUCT CERTIFICATION

No.: 2024312309000830

Annex: Page 2 of 10

AC=AC Power
 DC=DC Power
 gg: Fiber Optic
 00=None
 MM=MM
 SM=SM
 hh: RFID
 00=None
 C5=RFID Crypt
 C6=RFID ASC
 C8=RFID PC-SC

*: any alphanumeric or symbolic characters, without relevance for explosion protection

+ Note - ORCA is a combination of an E-Box and D-Box that are only certified together. Each D-Box and E-Box has their own nomenclature configuration depending on options included and both the D-Box and E-Box nomenclature is included on the label drawing. When option “0” or “00” is selected as noted by the “+”, this indicates that the option is not a part of the respective D-Box or the E-Box configuration.

PARAMETERS RELATING TO THE SAFETY:

Non-intrinsically safe circuits:

Terminal block X1 POWER



Nanyang Explosion Protected Electrical Apparatus Research Institute Co.,Ltd.



中国认可
产品
PRODUCT
CNAS C208-P

<http://www.ccc-cnex.com> Add: No. 20, North Zhongjing Road, Nanyang, Henan, P. R. China P.C.: 473008 Tel: 0377-63239734
ccc.china-ex.com Email: ccc@cn-ex.com



CERTIFICATE FOR CHINA COMPULSORY PRODUCT CERTIFICATION

No.: 2024312309000830

Annex: Page 3 of 10

Non-intrinsically safe supply circuits (Power)

Nominal voltage

For DC version (ORCA01EccdeDCgghh*) ,
24VDC (19.2...31.2VDC)

For AC version (ORCA01EccdeACgghh*) ,
100/230VAC (85...250VAC) (47...63Hz)

Nominal current

For DC version (ORCA01EccPeDCgghh*) , $I_{max} \leq 6.3A$, $I_{nom} = 4.2A$

For DC version (ORCA01EccSeDCgghh*) , $I_{max} \leq 4A$, $I_{nom} = 2.7A$

For AC version (ORCA01EccPeACgghh*) , $I_{max} \leq 2A$, $I_{nom} = 1.4A$

Nominal power: $P_{nom} \leq 150W$

Max. input voltage: $U_m = 250VAC$

Terminal block X2

Non-intrinsically safe circuits X2 (LAN 0) and

Nominal voltage: $U_{nom} = 5VAC/DC$

Max. input voltage: $U_m = 30VDC$

Terminal block X3

Non-intrinsically safe circuits X3 (USB 0)



Nanyang Explosion Protected Electrical Apparatus Research Institute Co.,Ltd.



<http://www.ccc-cnex.com>
ccc.china-ex.com

Add: No. 20, North Zhongjing Road, Nanyang,
Henan, P. R. China P.C.: 473008

Tel: 0377-63239734
Email: ccc@cn-ex.com



CERTIFICATE FOR CHINA COMPULSORY PRODUCT CERTIFICATION

No.: 2024312309000830

Annex: Page 4 of 10

Nominal voltage: $U_{nom}=5VAC/DC$

Max. input voltage: $U_m=30VAC$

Terminal block X4

Non-intrinsically safe circuits X4 (SERIAL)

Nominal voltage: $U_{nom}=12VAC/DC$

Max. input voltage: $U_m=30VAC$

Terminal block X10

This interface exist optionally in ORCA01EccPeffgghh*,

In case of Cooper LAN 1 interface:

Non-intrinsically safe circuits X10

Nominal voltage: $U_{nom}=5VAC/DC$

Max. input voltage: $U_m=30VDC$

Terminal block X11

This interface exist optionally in ORCA01EccPeffgghh*,

Non-intrinsically safe circuits X11 (USB 3)

Nominal voltage: $U_{nom}=5VAC/DC$

Max. input voltage: $U_m=30VAC$

Terminal block X12



Nanyang Explosion Protected Electrical
Apparatus Research Institute Co.,Ltd.



<http://www.ccc-cnex.com>
ccc.china-ex.com

Add: No. 20, North Zhongjing Road, Nanyang,
Henan, P. R. China P.C.: 473008

Tel: 0377-63239734
Email: ccc@cn-ex.com



CERTIFICATE FOR CHINA COMPULSORY PRODUCT CERTIFICATION

No.: 2024312309000830

Annex: Page 5 of 10

This interface exist optionally in ORCA01EccPeffgghh*.

This interface can exist according to the option with one of the following configurations:

In case of AUDIO interface:

Non-intrinsically safe circuits X12 (AUDIO)

Nominal voltage: $U_{nom}=12VAC/DC$

Max. input voltage: $U_m=30VDC$

For passive apparatus only.

In case of USB 2 interface:

Non-intrinsically safe circuits X12 (USB)

Nominal voltage: $U_{nom}=5VAC/DC$

Max. input voltage: $U_m=30VAC$

Terminal block X13

This interface exist optionally in ORCA01EccPeffgghh* ,

Non-intrinsically safe circuits X13 (USB 3)

Nominal voltage: $U_{nom}=5VAC/DC$

Max. input voltage: $U_m=30VAC$

Terminal block X14 Service Port





Nanyang Explosion Protected Electrical
Apparatus Research Institute Co.,Ltd.



<http://www.ccc-cnex.com>
ccc.china-ex.com

Add: No. 20, North Zhongjing Road, Nanyang,
Henan, P. R. China P.C.: 473008

Tel: 0377-63239734
Email: ccc@cn-ex.com

	CERTIFICATE FOR CHINA COMPULSORY PRODUCT CERTIFICATION
No.: 2024312309000830	
Annex: Page 6 of 10	
<p>This port is not allowed to be used.</p> <p>It is restricted to internal and service use and only in safe and secure areas!</p>	
<p>Terminal blocks X15 and X16</p> <p>These interfaces exist optionally in ORCA01EccPeffggh*.</p> <p>In case of Optical fiber X15-LAN1-FO and X16-LAN2-FO interface:</p> <p>Optical radiation sources for use in EPL Gb or Gc and Db or Dc applications which comply with Class 1 limits in accordance with GB 7247.1 is used.</p>	
<p>Intrinsically safe circuits (level of protection Ex ia IIC resp. Ex ia IIIC):</p>	
<p>Terminal blocks X5 and X6</p> <p>For connection of passive intrinsically safe apparatus e.g., keyboard and mouse.</p> <p>For each terminal blocks X5 (USB4) and X6 (USB5):</p> <p style="padding-left: 40px;">Terminals 1(+), 2(D-), 3(D+), 4(GND).</p> <p>Max. output voltage: $U_o=5.36VDC$</p> <p>Max. output current: $I_o=249mA$</p> <p>Max. output power: $P_o=0.341W$</p> <p>Max. external capacitance: $C_o=65\mu F$</p>	
	<p>Nanyang Explosion Protected Electrical Apparatus Research Institute Co.,Ltd.</p>
	
<p>http://www.ccc-cnex.com ccc.china-ex.com</p>	<p>Add: No. 20, North Zhongjing Road, Nanyang, Henan, P. R. China P.C.: 473008</p>
<p>Tel: 0377-63239734 Email: ccc@cn-ex.com</p>	



CERTIFICATE FOR CHINA COMPULSORY PRODUCT CERTIFICATION

No.: 2024312309000830

Annex: Page 7 of 10

for max. external inductance: $L_o=1\mu\text{H}$

or

Max. external capacitance: $C_o=46\mu\text{F}$

for max. external inductance: $L_o=2\mu\text{H}$

or

Max. external capacitance: $C_o=32\mu\text{F}$

for max. external inductance: $L_o=3\mu\text{H}$

or

Max. external capacitance: $C_o=25\mu\text{F}$

for max. external inductance: $L_o=4\mu\text{H}$

or

Max. external capacitance: $C_o=21\mu\text{F}$

for max. external inductance: $L_o=5\mu\text{H}$

Terminal block X9

For connection of passive intrinsically safe apparatus e.g., a power button.

For each terminal blocks X9 (BTN - Power Button)

Terminals 1(+), 2(GND).

Max. output voltage: $U_o=5.36\text{VDC}$



Nanyang Explosion Protected Electrical
Apparatus Research Institute Co.,Ltd.



<http://www.ccc-cnex.com>
ccc.china-ex.com

Add: No. 20, North Zhongjing Road, Nanyang,
Henan, P. R. China P.C.: 473008

Tel: 0377-63239734
Email: ccc@cn-ex.com



CERTIFICATE FOR CHINA COMPULSORY PRODUCT CERTIFICATION

No.: 2024312309000830

Annex: Page 8 of 10

Max. output current: $I_o=45\text{mA}$

Max. output power: $P_o=0.061\text{W}$

Linear output characteristics

Max. external capacitance: $C_o=64\mu\text{F}$

for max. external inductance: $L_o=0.89\mu\text{H}$

or

Max. external capacitance: $C_o=20\mu\text{F}$

for max. external inductance: $L_o=3.89\mu\text{H}$

Intrinsically safe circuits (level of protection Ex ib IIC resp. Ex ib IIIC):

Terminal blocks X7 and X8

For connection of passive intrinsically safe apparatus e.g., USB-Stick

For each terminal blocks X7 (USB6) and X8 (USB6):

Terminals 1(+), 2(D-), 3(D+), 4(GND).

Max. output voltage: $U_o=5.54\text{VDC}$

Max. output current: $I_o=757\text{mA}$

Max. output power: $P_o=3.9\text{W}$

Max. external capacitance: $C_o=48.6\mu\text{F}$



Nanyang Explosion Protected Electrical
Apparatus Research Institute Co.,Ltd.



<http://www.ccc-cnex.com>
ccc.china-ex.com

Add: No. 20, North Zhongjing Road, Nanyang,
Henan, P. R. China P.C.: 473008

Tel: 0377-63239734
Email: ccc@cn-ex.com



CERTIFICATE FOR CHINA COMPULSORY PRODUCT CERTIFICATION

No.: 2024312309000830

Annex: Page 9 of 10

for max. external inductance: $Lo=1\mu H$

or

Max. external capacitance: $Co=33.6\mu F$

for max. external inductance: $Lo=2\mu H$

or

Max. external capacitance: $Co=21.6\mu F$

for max. external inductance: $Lo=3\mu H$

or

Max. external capacitance: $Co=15.6\mu F$

for max. external inductance: $Lo=4\mu H$

or

Max. external capacitance: $Co=11.6\mu F$

for max. external inductance: $Lo=5\mu H$

Ex Marking:

Ex eb ib qb [ib] [ia Ga] IIC T4 Gb, Ex tb [ib] [ia Da] IIIC T115°C Db

- Manufacturer should organize production in accordance with the technical documents approved by the certification body.

2. Specific conditions of use:



Nanyang Explosion Protected Electrical
Apparatus Research Institute Co.,Ltd.



<http://www.ccc-cnex.com>
ccc.china-ex.com

Add: No. 20, North Zhongjing Road, Nanyang,
Henan, P. R. China P.C.: 473008

Tel: 0377-63239734
Email: ccc@cn-ex.com



CERTIFICATE FOR CHINA COMPULSORY PRODUCT CERTIFICATION

No.: 2024312309000830

Annex: Page 10 of 10

- Ingress Protection: IP65.
- Ambient temperature: -20°C~+55°C.
- WARNING - Potential electrostatic charging hazard - Clean only with a damp cloth! See instructions.
- The devices (inclusive connection cables) shall only be installed in areas where intensive electrostatic charging processes are excluded.
- The intrinsically safe circuits are connected to earth. Along the intrinsically safe circuits, potential equalization must exist or the intrinsically safe apparatus connected must meet the 500 V r.m.s dielectric strength test between circuit and the frame.
- Maximum over voltage category II according to GB/T16935.1 is permitted for the non-intrinsically safe circuits.
- Before application, CCC certified cable gland that suitable for the conditions of use and/or stopping plug shall be applied, and correctly installed.
- See instruction for other information.

3. Certificate related report(s)

- Type test report: CQST2403C014.

4. Certificate change information: None.



Nanyang Explosion Protected Electrical
Apparatus Research Institute Co.,Ltd.



<http://www.ccc-cnex.com>
ccc.china-ex.com

Add: No. 20, North Zhongjing Road, Nanyang,
Henan, P. R. China P.C.: 473008

Tel: 0377-63239734
Email: ccc@cn-ex.com

25.1.4.2 ORCA01M*



CERTIFICATE FOR CHINA COMPULSORY PRODUCT CERTIFICATION

No.: 2024312309000829

Applicant and address

R. STAHL HMI Systems GmbH
Adolf-Grimme-Allee 8, 50829 Köln, Germany

Manufacturer and address

R. STAHL HMI Systems GmbH
Adolf-Grimme-Allee 8, 50829 Köln, Germany

Factory and address

R. STAHL HMI Systems GmbH
Adolf-Grimme-Allee 8, 50829 Köln, Germany

Product, series, specification and model

Operator Terminals
ORCA01Mccdeffggh*

Ex ec ib qb [ib] [ia Ga] IIC T4 Gc, Ex tc [ib] [ia Da] IIIC T115°C Dc

Standards

GB/T 3836.1-2021, GB/T 3836.3-2021, GB/T 3836.4-2021, GB/T 3836.7-2017,
GB/T 3836.31-2021

This product(s) complies with the requirements of CNCA-C23-01: 2024
China Compulsory Certification Implementation Rule on Explosion
Protected Electrical Product.

Issue date: 2024-06-18 Valid to: 2029-06-17

Detailed information and status of this certificate is available by using the QR code,
visiting CNEX's website or CNCA's website: www.cnca.gov.cn.

This translated document has no legal effect and shall not be used alone.







Director:



Nanyang Explosion Protected Electrical
Apparatus Research Institute Co.,Ltd.

<http://www.ccc-cnex.com>
ccc.china-ex.com

Add: No. 20, North Zhongjing Road, Nanyang,
Henan, P. R. China P.C.: 473008

Tel: 0377-63239734
Email: ccc@cn-ex.com



CERTIFICATE FOR CHINA COMPULSORY PRODUCT CERTIFICATION

No.: 2024312309000829

Annex: Page 1 of 11

Product information:

1. This certificate covers the following models:

- ORCA01Mccdeffggh*

Nomenclature:

ORCA	01	M	cc	d	e	ff	gg	hh	*
	a	b	cc	d	e	ff	gg	hh	*

a: 01= Revision 01

b: M=Zone 2 / 22 (EPL Gc / Dc)

cc: Technology

00=None+

TC=Technology Thin Client / Panel PC

DM=Technology Direct Monitor

d: E-Box

0=None+

S=Standard

P=Pro

e: D-Box

0=None+

3=Size 3

4=Size 4

6=Size 6

ff: Power

00=None+



Nanyang Explosion Protected Electrical
Apparatus Research Institute Co.,Ltd.



<http://www.ccc-cnex.com>
ccc.china-ex.com

Add: No. 20, North Zhongjing Road, Nanyang,
Henan, P. R. China P.C.: 473008

Tel: 0377-63239734
Email: ccc@cn-ex.com



CERTIFICATE FOR CHINA COMPULSORY PRODUCT CERTIFICATION

No.: 2024312309000829

Annex: Page 2 of 11

AC=AC Power
DC=DC Power
gg: Fiber Optic
00=None
MM=MM
SM=SM
hh: RFID
00=None
C5=RFID Crypt
C6=RFID ASC
C8=RFID PC-SC

*: any alphanumeric or symbolic characters, without relevance for explosion protection

+ Note - ORCA is a combination of an E-Box and D-Box that are only certified together. Each D-Box and E-Box has their own nomenclature configuration depending on options included and both the D-Box and E-Box nomenclature is included on the label drawing. When option “0” or “00” is selected as noted by the “+”, this indicates that the option is not a part of the respective D-Box or the E-Box configuration.

PARAMETERS RELATING TO THE SAFETY:

Non-intrinsically safe circuits:

Terminal block X1 POWER



Nanyang Explosion Protected Electrical Apparatus Research Institute Co.,Ltd.



<http://www.ccc-cnex.com>
ccc.china-ex.com

Add: No. 20, North Zhongjing Road, Nanyang,
Henan, P. R. China P.C.: 473008

Tel: 0377-63239734
Email: ccc@cn-ex.com



CERTIFICATE FOR CHINA COMPULSORY PRODUCT CERTIFICATION

No.: 2024312309000829

Annex: Page 3 of 11

Non-intrinsically safe supply circuits (Power)

Nominal voltage

For DC version (ORCA01MccdeDCgghh*) ,
24VDC (19.2...31.2VDC)

For AC version (ORCA01MccdeACgghh*) ,
100/230VAC (85...250VAC) (47...63Hz)

Nominal current

For DC version (ORCA01MccPeDCgghh*) , $I_{max} \leq 6.3A$, $I_{nom} = 4.2A$

For DC version (ORCA01MccSeDCgghh*) , $I_{max} \leq 4A$, $I_{nom} = 2.7A$

For AC version (ORCA01MccPeACgghh*) , $I_{max} \leq 2A$, $I_{nom} = 1.4A$

Nominal power: $P_{nom} \leq 150W$

Max. input voltage: $U_m = 250VAC$

Terminal block X2

Non-intrinsically safe circuits X2 (LAN 0) and

Nominal voltage: $U_{nom} = 5VAC/DC$

Max. input voltage: $U_m = 30VDC$

Terminal block X3

Non-intrinsically safe circuits X3 (USB 0)



Nanyang Explosion Protected Electrical
Apparatus Research Institute Co.,Ltd.



<http://www.ccc-cnex.com>
ccc.china-ex.com

Add: No. 20, North Zhongjing Road, Nanyang,
Henan, P. R. China P.C.: 473008

Tel: 0377-63239734
Email: ccc@cn-ex.com



CERTIFICATE FOR CHINA COMPULSORY PRODUCT CERTIFICATION

No.: 2024312309000829

Annex: Page 4 of 11

<p>Nominal voltage: $U_{nom}=5VAC/DC$ Max. input voltage: $U_m=30VAC$</p>
<p>Terminal block X4 Non-intrinsically safe circuits X4 (SERIAL) Nominal voltage: $U_{nom}=12VAC/DC$ Max. input voltage: $U_m=30VAC$</p>
<p>Terminal block X10 This interface exist optionally in ORCA01MccPeffggh*, In case of Cooper LAN 1 interface: Non-intrinsically safe circuits X10 Nominal voltage: $U_{nom}=5VAC/DC$ Max. input voltage: $U_m=30VDC$</p>
<p>Terminal block X11 This interface exist optionally in ORCA01MccPeffggh*, Non-intrinsically safe circuits X11 (USB 3) Nominal voltage: $U_{nom}=5VAC/DC$ Max. input voltage: $U_m=30VAC$</p>
<p>Terminal block X12</p>



Nanyang Explosion Protected Electrical Apparatus Research Institute Co.,Ltd.



<http://www.ccc-cnex.com>
ccc.china-ex.com

Add: No. 20, North Zhongjing Road, Nanyang,
 Henan, P. R. China P.C.: 473008

Tel: 0377-63239734
 Email: ccc@cn-ex.com



CERTIFICATE FOR CHINA COMPULSORY PRODUCT CERTIFICATION

No.: 2024312309000829

Annex: Page 5 of 11

This interface exist optionally in ORCA01MccPeffgghh*.

This interface can exist according to the option with one of the following configurations:

In case of AUDIO interface:

Non-intrinsically safe circuits X12 (AUDIO)

Nominal voltage: $U_{nom}=12VAC/DC$

Max. input voltage: $U_m=30VDC$

For passive apparatus only.

In case of USB 2 interface:

Non-intrinsically safe circuits X12 (USB)

Nominal voltage: $U_{nom}=5VAC/DC$

Max. input voltage: $U_m=30VAC$

Terminal block X13

This interface exist optionally in ORCA01MccPeffgghh* ,

Non-intrinsically safe circuits X13 (USB 3)

Nominal voltage: $U_{nom}=5VAC/DC$

Max. input voltage: $U_m=30VAC$

Terminal block X14 Service Port



Nanyang Explosion Protected Electrical
Apparatus Research Institute Co.,Ltd.



<http://www.ccc-cnex.com>
ccc.china-ex.com

Add: No. 20, North Zhongjing Road, Nanyang,
Henan, P. R. China P.C.: 473008

Tel: 0377-63239734
Email: ccc@cn-ex.com



CERTIFICATE FOR CHINA COMPULSORY PRODUCT CERTIFICATION

No.: 2024312309000829

Annex: Page 6 of 11

This port is not allowed to be used.

It is restricted to internal and service use and only in safe and secure areas!

Terminal blocks X15 and X16

These interfaces exist optionally in ORCA01MccPeffggh*,

In case of Optical fiber X15-LAN1-FO and X16-LAN2-FO interface:

Optical radiation sources for use in EPL Gb or Gc and Db or Dc applications which comply with Class 1 limits in accordance with GB 7247.1 is used.

Intrinsically safe circuits (level of protection Ex ia IIC resp. Ex ia IIIC):

Terminal blocks X5 and X6

For connection of passive intrinsically safe apparatus e.g., keyboard and mouse.

For each terminal blocks X5 (USB4) and X6 (USB5):

Terminals 1(+), 2(D-), 3(D+), 4(GND).

Max. output voltage: $U_o=5.36\text{VDC}$

Max. output current: $I_o=249\text{mA}$

Max. output power: $P_o=0.341\text{W}$

Max. external capacitance: $C_o=65\mu\text{F}$



Nanyang Explosion Protected Electrical
Apparatus Research Institute Co.,Ltd.



<http://www.ccc-cnex.com>
ccc.china-ex.com

Add: No. 20, North Zhongjing Road, Nanyang,
Henan, P. R. China P.C.: 473008

Tel: 0377-63239734
Email: ccc@cn-ex.com



CERTIFICATE FOR CHINA COMPULSORY PRODUCT CERTIFICATION

No.: 2024312309000829

Annex: Page 7 of 11

for max. external inductance: $L_o=1\mu\text{H}$

or

Max. external capacitance: $C_o=46\mu\text{F}$

for max. external inductance: $L_o=2\mu\text{H}$

or

Max. external capacitance: $C_o=32\mu\text{F}$

for max. external inductance: $L_o=3\mu\text{H}$

or

Max. external capacitance: $C_o=25\mu\text{F}$

for max. external inductance: $L_o=4\mu\text{H}$

or

Max. external capacitance: $C_o=21\mu\text{F}$

for max. external inductance: $L_o=5\mu\text{H}$

Terminal block X9

For connection of passive intrinsically safe apparatus e.g., a power button.

For each terminal blocks X9 (BTN - Power Button)

Terminals 1(+), 2(GND).

Max. output voltage: $U_o=5.36\text{VDC}$



Nanyang Explosion Protected Electrical
Apparatus Research Institute Co.,Ltd.



<http://www.ccc-cnex.com>
ccc.china-ex.com

Add: No. 20, North Zhongjing Road, Nanyang,
Henan, P. R. China P.C.: 473008

Tel: 0377-63239734
Email: ccc@cn-ex.com



CERTIFICATE FOR CHINA COMPULSORY PRODUCT CERTIFICATION

No.: 2024312309000829

Annex: Page 8 of 11

Max. output current: $I_o=45\text{mA}$

Max. output power: $P_o=0.061\text{W}$

Linear output characteristics

Max. external capacitance: $C_o=64\mu\text{F}$

for max. external inductance: $L_o=0.89\mu\text{H}$

or

Max. external capacitance: $C_o=20\mu\text{F}$

for max. external inductance: $L_o=3.89\mu\text{H}$

Intrinsically safe circuits (level of protection Ex ib IIC resp. Ex ib IIIC):

Terminal blocks X7 and X8

For connection of passive intrinsically safe apparatus e.g., USB-Stick

For each terminal blocks X7 (USB6) and X8 (USB6):

Terminals 1(+), 2(D-), 3(D+), 4(GND).

Max. output voltage: $U_o=5.54\text{VDC}$

Max. output current: $I_o=757\text{mA}$

Max. output power: $P_o=3.9\text{W}$

Max. external capacitance: $C_o=48.6\mu\text{F}$



Nanyang Explosion Protected Electrical
Apparatus Research Institute Co.,Ltd.



<http://www.ccc-cnex.com>
ccc.china-ex.com

Add: No. 20, North Zhongjing Road, Nanyang,
Henan, P. R. China P.C.: 473008

Tel: 0377-63239734
Email: ccc@cn-ex.com



CERTIFICATE FOR CHINA COMPULSORY PRODUCT CERTIFICATION

No.: 2024312309000829

Annex: Page 9 of 11

for max. external inductance: $Lo=1\mu H$

or

Max. external capacitance: $Co=33.6\mu F$

for max. external inductance: $Lo=2\mu H$

or

Max. external capacitance: $Co=21.6\mu F$

for max. external inductance: $Lo=3\mu H$

or

Max. external capacitance: $Co=15.6\mu F$

for max. external inductance: $Lo=4\mu H$

or

Max. external capacitance: $Co=11.6\mu F$

for max. external inductance: $Lo=5\mu H$

Ex Marking:

Ex ec ib qb [ib] [ia Ga] IIC T4 Gc, Ex tc [ib] [ia Da] IIIC T115°C Dc

- Manufacturer should organize production in accordance with the technical documents approved by the certification body.

2. Specific conditions of use:



Nanyang Explosion Protected Electrical
Apparatus Research Institute Co.,Ltd.



<http://www.ccc-cnex.com>
ccc.china-ex.com

Add: No. 20, North Zhongjing Road, Nanyang,
Henan, P. R. China P.C.: 473008

Tel: 0377-63239734
Email: ccc@cn-ex.com



CERTIFICATE FOR CHINA COMPULSORY PRODUCT CERTIFICATION

No.: 2024312309000829

Annex: Page 10 of 11

- Ingress Protection: IP65.
- Ambient temperature: -20°C~+55°C.
- WARNING - Potential electrostatic charging hazard - Clean only with a damp cloth! See instructions.
- The equipment is intended for installation in an area providing at least pollution degree 2 as defined within GB/T 16935.1. Transient protection shall be provided that is set at a level not exceeding 140 % of the peak rated voltage value at the supply terminals to the equipment.
- The devices (inclusive connection cables) shall only be installed in areas where intensive electrostatic charging processes are excluded.
- The intrinsically safe circuits are connected to earth. Along the intrinsically safe circuits, potential equalization must exist or the intrinsically safe apparatus connected must meet the 500 V r.m.s dielectric strength test between circuit and the frame.
- Maximum over voltage category II according to GB/T16935.1 is permitted for the non-intrinsically safe circuits.
- Before application, CCC certified cable gland that suitable for the conditions of use and/or stopping plug shall be applied, and correctly installed.
- See instruction for other information.

3. Certificate related report(s)

- Type test report: CQST2403C013.



Nanyang Explosion Protected Electrical
Apparatus Research Institute Co.,Ltd.



<http://www.ccc-cnex.com>
ccc.china-ex.com

Add: No. 20, North Zhongjing Road, Nanyang,
Henan, P. R. China P.C.: 473008

Tel: 0377-63239734
Email: ccc@cn-ex.com



CERTIFICATE FOR CHINA COMPULSORY PRODUCT CERTIFICATION

No.: 2024312309000829

Annex: Page 11 of 11
4. Certificate change information: None.



Nanyang Explosion Protected Electrical Apparatus Research Institute Co.,Ltd.



中国认可
产品
PRODUCT
CNAS C208-P

<http://www.ccc-cnex.com> ccc.china-ex.com Add: No. 20, North Zhongjing Road, Nanyang, Henan, P. R. China P.C.: 473008 Tel: 0377-63239734 Email: ccc@cn-ex.com

25.2 Declaration of conformity for Equipment Compilation

R. STAHL HMI Systems GMBH

Adolf-Grimme-Allee 8 • 50829 Köln / Cologne • Germany



Betriebsanleitung für Gerätezusammenstellung / Instruction Manual for Equipment Compilation:

Diese Betriebsanleitung verweist auf die jeweilige Betriebsanleitung der verbauten Geräte. In den Betriebsanleitungen der verbauten Geräte sind alle sicherheitsrelevanten und für Installation und Betrieb erforderlichen Angaben enthalten.

Für den ordnungsgemäßen Betrieb aller zusammengehörigen Komponenten sind, außer dieser Betriebsanleitung, alle weiteren der Lieferung beigelegten Betriebsanleitungen sowie die Betriebsanleitungen der anzuschließenden Zusatzgeräte zu beachten!

Beachten Sie weiterhin, dass alle Zertifikate der Bediengeräte in einem separaten Dokument zu finden sind, welches im Internet (www.r-stahl.com) zur Verfügung steht.

This Instruction Manual refers to the documents of the devices used. All instructions concerning the installation and safe use of these devices are documented in the attached detailed instruction manuals.

It is important for safe use to follow these instructions as well all instructions of other associated devices!

Please note that all certificates of the operating and monitoring devices are available at (www.r-stahl.com).

Konformitätserklärung für Gerätezusammenstellung / Declaration of Conformity for Equipment Compilation:

Die R. STAHL HMI Systems GmbH erklärt in alleiniger Verantwortung, dass durch die Zusammenschaltung der Geräte, welche im zugehörigen Lieferschein aufgeführt sind, die Gesamtkonformität gemäß Richtlinie 2014/34/EU und 2014/30/EU und ggf. 2014/34/EU und 2014/53/EU gegeben ist.

Des Weiteren verweisen wir auf die jeweilige Konformitätserklärung der bei diesem Zusammenbau verwendeten Geräte. Diese liegen bei bzw. sind in der beiliegenden Betriebsanleitung abgedruckt.

R. STAHL HMI Systems GmbH declares in its sole responsibility that the interconnection of the devices listed in the accompanying delivery note is in conformity with directives 2014/34/EU, 2014/30/EU and, where applicable, 2014/34/EU and 2014/53/EU.

Furthermore, we refer to the individual Declarations of Conformity of the devices used, which are attached or are part of the attached operating instructions.

Köln/Cologne, September 2022

S. Zehrer
Production Director

A. Jung
Director R&D

R. STAHL HMI Systems GmbH
Adolf-Grimme-Allee 8
50829 Köln (Cologne)
Germany

T +49 221 76 806-1200
F +49 221 76 806-4200
sales.dehm@r-stahl.com
exicom.de

Headquarters: Köln
Local Court – Court of Registration:
Köln HRB 73049
VAT REG No. DE279883744

Management:
Carsten Brenner
Philipp Ohler

25.3 Evaluation of transponder media

25.3.1 RFID chip cards

BVS Elektrostatikprüfung / Electrostatic Test			DEKRA EXAM GmbH Fachstelle für Sicherheit elektrischer Betriebsmittel - BVS- Carl-Beyling-Haus Dinnendahlstraße 9 44809 Bochum
Prüfschein / Test Report BVS PS 23691 vom / date 12.04.2010			
Antragsnummer/ job identification number: 20100206	SD Nummer: 180208766 30	Sachverständiger/ expert: Ha	
Prüfgegenstand / test specimen	: Chip Karten		
Antragsteller / applicant	: R. Stahl HMI Systems GmbH		
Hersteller / manufacturer	: dto.		
Typenbezeichnung / type designation	: Wiegand, RFID.MIFARE 13,8 MHz		
Schutzart / type of protection	: Kat. 1G, 2G, 1D, 2D		
Prüfauftrag vom / date of order	: 08.03.10		
BVS-PMNr. / reg.-number	: 086/10		
Zeichnungsnummer / drawing number	: -		
<u>Datum der Prüfung / Date of test:</u>		25.03.10	
<u>Prüfer / Testing engineer:</u>		Dr.-Ing. Wittler	
<u>Prüfung / Test:</u>		Elektrostatikprüfung an Prüfplatten nach IEC 60079-0: 2007	
<u>Durchführung der Prüfung / Test conditions:</u>			
Umgebungsbedingungen: Raumtemperatur 23°C, Relative Luftfeuchte 28 ... 29% Vor Beginn der Prüfung wurde der Prüfling mit Isopropanol gereinigt, mit destilliertem Wasser gespült und anschließend für 24 Stunden in dem oben angegebenen Klima gela- gert. Anschließend wurde der Prüfling manuell mit Leder-, Polyamid- und Baumwolltuch (je 20 Schläge) sowie mit Hochspannung (40 kV) aufgeladen. Danach wurde versucht einzelne Entladungen zu einer geerdeten 15 mm Kugelelektrode- einzuleiten.			
<u>Ergebnisse / Results:</u>		siehe Seite 2	



DEKRA EXAM GmbH
 Fachstelle für
 Sicherheit elektrischer
 Betriebsmittel - BVS

Carl-Beyling-Haus
 Dinnendahlstraße 9
 44809 Bochum

Seite 2 von 2 zum Prüfschein BVS PS 23691 vom 12.04.2010

Prüfmuster	Maximale Ladungsstärke nach manueller Aufladung (relevant für Kat. 2G)	Maximale Ladungsstärke nach Aufladung mit Hochspannung (relevant für Kat. 1G, 1D und 2D)
RFID.MIFARE 13,8 MHz	18 nC*	50 nC**
Wiegand	17 nC*	85 nC***

- * Büschelentladungen > 10 nC (≤ 30 nC) sind elektrostatisch bedenklich für Gruppe IIC, unbedenklich für Gruppe IIB und Gruppe IIA
- ** Büschelentladungen > 30 nC (≤ 60 nC) sind elektrostatisch bedenklich für Gruppe IIB und Gruppe IIC, unbedenklich für Gruppe IIA
- *** Büschelentladungen > 60 nC sind elektrostatisch bedenklich für Gruppe IIA; Büschelentladungen < 200 nC sind elektrostatisch unbedenklich für Kategorie Kat. 1D und 2D

Prüfmittel / Test apparatus:

Ladungsmessgerät

DEKRA EXAM GmbH
 Fachstelle für Sicherheit elektrischer Betriebsmittel
 Bergbau-Versuchsstrecke

12.04.2010 Dr. Wittler
 (Datum, Prüfer Dr.-Ing. Wittler)

14.4.10 Hawk
 (Datum, für die Richtigkeit)

Dieser Prüfschein darf nur vollständig und unverändert weiter gegeben werden.

25.3.2 RFID tag

Konformitätsbewertung
Conformity Assessment

R. STAHL HMI Systems GmbH • Im Gewerbegebiet Pesch 14 • 50767 Köln • Germany

erklärt, dass das Produkt
declares that the product

RFID-Tag Typ: Mifare-eXis-1K-S50-ISO14443-*

gefährlos in den Bereich einer explosionsgefährdeten Atmosphäre der Kategorie 2 G/D und 3 G/D eingebracht werden kann unter Beachtung der folgenden Bedingungen gemäß Namur NE127:

- Umgebungsfeldstärken von ≤ 1 A/m oder ≤ 3 V/m;
- Umgebungstemperatur an der Außenseite des Transponders ≤ 40 °C für die Betrachtung nach Temperaturklasse T6;
- Frequenzbereich > 10 MHz.

Eine Gefährdung durch statische Aufladung wird unter Berücksichtigung der Forderungen aus EN/IEC 60079-0 ausgeschlossen.

can be utilised without risk in areas with a potentially explosive atmosphere of category 2 G/D and 3 G/D under the following conditions according to Namur NE127:

- *Ambient field strengths of ≤ 1 A/m or ≤ 3 V/m;*
- *Ambient temperature on the transponder exterior ≤ 40 °C for consideration in compliance with temperature class T6;*
- *Frequency range > 10 MHz.*

The potential for electrostatic charging has been taken into consideration according to the requirements of EN/IEC 60079-0.

Köln, 12 April 2013

Ort und Datum
Place and date
Lieu et date

A handwritten signature in black ink, appearing to read "W. Bertges", written over a horizontal line.

W. Bertges
Quality Manager

Datei: RFID-exis_Konfbew_20130412.docx

25.4 Conformity assessment card holder

Konformitätsbewertung Conformity Assessment



R. STAHL HMI Systems GmbH • Adolf-Grimme-Allee 8 • 50829 Köln, Germany

erklärt, dass das Produkt
declares that the product

Card-Holder-01

gefahrlos in den Bereich einer explosionsgefährdeten Atmosphäre des EPL Gb/Gc IIC und Db/Dc eingebracht werden kann, unter Beachtung der folgenden Bedingungen:

- Der Card-Holder-01 ist nur für fest installierte Anlagen zu verwenden.
- Für die Benutzung des Card-Holder-01 in EPL Db/Dc sind hochenergetische Lademechanismen an der Oberfläche (z.B. pneumatischer Partikeltransport) bei der Verwendung auszuschließen. Der Card-Holder-01 darf nicht in Umgebungen verwendet werden, in denen mit Gleitbüschelentladung zu rechnen ist.
- Der Card Holder 01 darf nur mit einem feuchten Tuch gereinigt werden.

Eine Gefährdung durch statische Aufladung wird unter Berücksichtigung der Forderungen aus EN/IEC 60079-0, der Konstruktion nach Montageanleitung 10570163 und der aufgelisteten Bedingungen ausgeschlossen.

can be utilised without risk in areas with a potentially explosive atmosphere of EPL Gb/Gc IIC und Db/Dc under the following conditions:

- *The Card-Holder-01 may only be used for fixed installations.*
- *If you want to use the Card-Holder-01 in EPL Db/Dc, you have to ensure that no high-energy loading mechanisms at the operating surface of the unit (e.g. pneumatic particle transport) occur during operation. The Card-Holder-01 may not be used in environments where propagating brush discharges may occur.*
- *The Card-Holder-01 may be cleaned with a damp cloth only.*

The potential for electrostatic charging has been taken into consideration according to the requirements of EN/IEC 60079-0, the design according to mounting instruction 10570163 and the listed conditions.

Köln, 2019-01-21

Ort und Datum
Place and date
Lieu et date

i.V.

A. Jung
Ex Representative

Datei: 20190370000 Konformitätsbewertung Card-Holder-01.docx

26 Appendix J

26.1 Release notes

This chapter lists the changes made in the most recent versions of these Operating Instructions.

Version 01.00.08

- Deletion of older release notes
- New HW-Rev. 01.01.03
- Addition in table "Overview Hardware Revision ORCA01"
- Addition of "Corrosion resistance flowing mixed gas" in section "Technical data E/M5xA and E/M79A - Ambient conditions"
- Addition in table "Symbols on the device" with labelling for USA, Canada, India, China
- Addition of USA and Canada approval NEC, CE-code in section "Approvals"
- Addition of USA and Canada marking in section "Ex marking"
- Addition in table "Intended use"
- Renew "Control Drawing"
- Addition of Declaration of conformity USA / Canada UL
- Changing screw plugs into CMP for devices with NEC / CEC approval, adaptation of "Technical data" in section "Cable glands"
- Changing data according to screw plugs in section "Installation – Cable glands"
- Addition of section "Note on mounting and installation according to NEC / CE-Code / UL"
- Moving of "Installation according to Control Drawing 10608602" from section "Note on mounting and installation" to subsection "Note on mounting and installation according to NEC / CE code / UL"
- Addition of section "WLAN and Bluetooth adaptor" in "Technical data"
- Removal of "only for 12" and 15" devices" at position 27 "Enclosure option" for slim enclosure in section "Type key code field system"
- Addition of value "8" at position 27 "Enclosure option" in section "Type key code field system"
- Addition of "Enclosure versions and sun roof" at "Optional components" in section "Operator Station"
- Addition of text according to "equipment with sun roof" in section "Note on mounting and installation"
- Addition of drawing "Dimensions" for "Operator Station ORCA-FR with sun roof"
- Changing attribute value for "Supported transponder media" in "Technical data", incl. note on UID / CSN
- Addition of option "Stick-on card holder" at "Optional components" in section "D-Box"
- Addition of information according to "card holder" in section "Card reader for access control"
- Addition of chapter "Mounting instruction card holder"
- Addition of chapter "Evaluation of transponder media and card holder"
- Addition of list of documents in section "Further documents"
- Changing attribute value for "Degree of protection (IP)" in "Technical data"
- Changing text according to "IP protection" in general
- Formal changes

R. STAHL HMI Systems GmbH
Adolf-Grimme-Allee 8
D 50829 Cologne

T:	(Sales Support)	+49 221 768 06 - 1200
	(Technical Support)	+49 221 768 06 - 5000
F:		+49 221 768 06 - 4200
E:	(Sales Support)	sales.dehm@r-stahl.com
	(Technical Support)	support.dehm@r-stahl.com

r-stahl.com



THE STRONGEST LINK.