



Operating Instructions

Exicom Open HMI ET-4x6-Tx, ET-4x6-Fx
(valid for HW Revision 2., 5th Supplement)

R. STAHL HMI Systems GmbH
Im Gewerbegebiet Pesch 14
50767 Köln

HW-Rev. ET-4x6-Tx: 02.05.23
HW-Rev. ET-4x6-Fx: 02.05.13

Operating instructions version: 02.05.12
Issue: 29.06.2011

Table of contents

	Description	Page
	Table of contents	2
1	Preface	4
2	Device function ET-4x6-Tx, ET-4x6-Fx	4
3	General Information	5
3.1	Licensing issues	5
3.2	Recovery Stick	5
3.3	Backup	5
3.4	Initial start-up	5
3.5	Switching off and shutting down	6
3.5.1	Notes on Windows XP Embedded	6
3.6	Installation off Windows XP Professional	7
3.7	Keyboard features	7
4	Technical details	8
5	Conformity to standards	9
6	Certifications	10
6.1	ATEX	10
6.2	DNV	10
6.3	GOST-R	10
6.4	UL INMETRO	10
6.5	CNEX	10
6.6	CKT	10
6.7	UL	11
7	Product identification	11
8	Power supply	11
8.1	Operator interfaces	11
8.2	Reader modules	11
9	Permitted maximum values	12
9.1	External, non-intrinsically safe circuits	12
9.2	External inherently safe optical interface	12
9.3	External intrinsically safe circuits	13
10	Type code	18
11	Safety Advice	19
11.1	Installation and operation	19
11.2	Special conditions	20
11.3	Installation via USB interfaces	20
11.3.1	Software installation using a USB Memory Stick	20
11.3.2	Software installation with external USB devices	20
11.4	USB interfaces	21
11.4.1	I.S. USB interfaces USB0, USB2	21
11.4.2	Ex-e USB interfaces USB1, USB3	21
11.4.2.1	Connection variations for Ex-e USB interfaces	21
11.4.2.2	Connection terminal of protection type "e" (EN 60079-7)	22
12	Hard disk Exicom-SHD-xxx	24
12.1	Installation of hard disk	24

12.2	Warnings	24
12.3	Changing of hard disk	24
13	Installation	25
13.1	General information	25
13.2	ET-4x6-Tx, ET-4x6-Fx	25
14	Assembly and disassembly	26
14.1	General information	26
14.2	Cut-out ET-4x6	26
15	Operation	26
15.1	General information	26
15.2	Connections ET-4x6	27
15.2.1	Dip switch settings S3 and S4	28
15.3	Connections Ex-e terminals (X12)	29
15.3.1	Labeling I.S. circuits	29
15.3.2	Connection details of the I.S. terminals	29
15.3.3	Connection details of the Ex-e terminals	29
15.3.4	Cable types and cross sections	29
16	Maintenance, service	30
16.1	Servicing	30
16.2	Time function	30
17	Troubleshooting	30
18	Disposal	31
18.1.1	ROHS directive 2002/95/EC	31
18.1.2	China ROHS labeling	31
19	Front panel resistance	32
19.1	Design	32
19.2	Materials	33
19.3	Material properties	33
19.3.1	Entire device	33
19.3.2	Membrane top	34
19.3.3	Display / Touch screen	36
19.3.4	Front panel seal	36
20	UL Certification	37
20.2.1	Caution	37
20.3.1	Electrical	38
20.3.2	Temperature range	38
20.4	Device with UL certification	39
20.5	Control Drawings	40
21	Accessories	43
21.1	Phoenix Contact terminal block	43
21.1.1	Data sheet Mini-Ex-terminal	43
22	Declaration of EC conformity	46
23	Release Notes	47

1 Preface

These operating instructions are intended for the safe installation of the Open HMI series operator interfaces and cover all Ex-relevant aspects. Furthermore, these operating instructions contain all necessary information for assembly and connection of the operator interfaces.



For the correct operation of all associated components please note, in addition to these operating instructions, all other operating instructions enclosed in this delivery as well as the operating instructions of the additional equipment to be connected.



Please also note that all certificates of the operator interfaces can be found in a separate document !

2 Device function ET-4x6-Tx, ET-4x6-Fx

The ET-4x6-Tx and ET-4x6-Fx operator interfaces are intelligent display and operating devices which can run any software. They are certified according to ATEX directive 94/9/EC for installation in hazardous areas of zones 1, 2, 21 and 22.

The ET-4x6-Tx and ET-4x6-Fx operator interfaces can also be used as thin clients in a remote terminal environment. As a standard, all Open HMIs are equipped with a touch screen and several interfaces, are based on the powerful Pentium / Celeron M or ATOM technology (up to 1.6 GHz clock frequency), which makes them the most powerful devices on the market. Their modular structure makes changes and maintenance easy.

3 General Information

3.1 Licensing issues

The Open HMI series operator interfaces are fully pre-installed with the Windows XP Embedded or Windows XP Professional operating systems.

The license sticker is affixed on the back of the operator interface, next to the type plate.

Please note that according to the license issued for Windows XP Embedded the application of this system as an Office PC is not permitted.

3.2 Recovery Stick

 To restore your Open HMI device to its original state you will need a Recovery Stick, which is available as an optional extra. This recovery stick (USB-drive, also available intrinsically safe) contains the factory image, with which the system can be restored to delivery status within a very short time.

Please note that you can restore the operator interfaces to their original state **only** with the aid of the Recovery Stick.

 As an option, the recovery stick can also contain a backup software, with which you can back up your own device configuration.

3.3 Backup

 We expressly point out that it is the responsibility of the user to generate a backup of the operator interfaces and thus their overall functionality !

 We expressly recommend to store such a backup of the operator interfaces on an external storage medium (USB stick (recovery stick), CD, DVD or similar) and/or on the company network !

3.4 Initial start-up

When the device is started for the first time, a Wizard starts where users have to select certain settings.

Please follow the instructions of the Wizard carefully.

 For further information regarding this Wizard please refer to the OpenHMI_help_en.chm help file in the "STAHL" directory on the operating interface or on the CD/DVD that is delivered with the device.

You will find the file on the CD/DVD in the following directory:

Handbuecher_Manuals\Software_eng\

3.5 Switching off and shutting down

- ☞ The Microsoft Windows operating system stores important data, regardless of the application, in the RAM whilst the system is running. Before the PC or operator interface is switched off, this data must be stored on the hard disk.
- ☞ For the operator interface to function safely and without faults it is therefore vitally important that the operator interface is shut down properly (see illustration below) and **NOT** simply switched off !
- ⚠ If this is not done, the existing image of the operator interface may become damaged and the device may cease functioning.



Once the data has been stored on the hard disk, Windows informs the user that the PC/the operator interface may now be switched off.

- ⚠ Only switch off the operator interface once this message has appeared !

3.5.1 Notes on Windows XP Embedded

When using the Windows XP Embedded operating system together with the Open HMI series operator interfaces users have the option of write-protection for their C:\ drive.

- ☞ This is **NOT** the case with the Windows XP Professional operating system !
- 📖 For further information regarding this write-protection please refer to the OpenHMI_help_en.chm help file in the "STAHL" directory on the operating interface or on the CD/DVD that is delivered with the device.
You will find the file on the CD/DVD in the following directory:
Handbuecher_Manuals\Software_eng\

Recommendation:

For applications that require constant writing to the data carrier R. STAHL HMI Systems GmbH recommends you use an external memory such as a USB stick or a network server.

3.6 Installation off Windows XP Professional

If Windows XP Professional will be installed by customers, you will get a message of the MSDTC service after the installation of the Windows XP Professional image. This message is the following:

The following services are dependent on the distributed transaction coordinator service. Stopping the distributed transaction coordinator service will also stop these services.

Message Queuing

Do you want to continue this operation ?



Due to that these MSDTC service is necessary for the SQL Server and the SQL Server is necessary for Siemens WinCC this message **MUST BE** confirmed with **YES** ! Otherwise the MSDTC service will not run.





3.7 Keyboard features

- ☞ Pressing two keys at once (e.g. F1 + F7) is not supported by the operator interfaces ! In such a case, the system considers the key that was pressed first as "active" and implements the associated functions and / or key bit functions ! The key pressed second is ignored.
- ☞ Pressing any three of the following keys at the same time has the same effect as pressing Ctrl + Alt + Del ! The keys are: F1, F2, F7 and F8.

ET-406 only:

- ☞ Pressing the S1 – S10 softkeys on the ET-406 has the same effect as pressing the numerical keys 0 – 9.
- ☞ As an alternative, you may also allocate the Shift + F1 – Shift + F10 functions to the S1 – S10 keys. If this is required, it must be stated when ordering, as it can only be done by the manufacturer **before delivery**.

4 Technical details

				
Function / Equipment	ET-406	ET-416	ET-436	ET-456
Display type	TFT Color, 262144 colors			
Display size	26 cm (10,4")		38 cm (15")	48 cm (19")
Resolution	SVGA 800 x 600 Pixel		XGA 1024 x 768 Pixel	SXGA 1280 x 1024 Pixel
Display	Touch Screen on glass			
Touch Screen	8-wire analogue resistive			
Lighting	CFL backlight			
Service life of backlight at 25°C	50,000h			
Brightness	350 cd/m ²		250 cd/m ² (optional 600 cd/m ²)	300 cd/m ²
Keyboard	Polyester membrane on FR4 material; > 1 million actions			
Functional keys	12	12	8	8
Freely assignable / number	Yes / 12	no	no	no
Soft keys	10	no	no	no
Cursor keys	Yes	no	no	no
Alphanumeric keys	23	no	no	no
Numeric keys	Yes	no	no	no
External keyboard	optional			
Trackball / Joystick	optional			
Real time clock / Data buffer	Yes (capacitor buffered, maintenance-free) / > 4 days			
Interfaces				
Communication COM1 and COM2	RS-232, RS-422, RS-485			
Fieldbus	MPI with MPI Box SSW7-HMI-RS-422			
Ethernet	Alternatively Tx or Fx			
Copper (Tx)	10/100BaseTx, 10/100 Mbit, increased safety (Ex-e)			
Optical fiber (Fx)	100BaseFx, 100 Mbit, inherently safe (Ex op is)			
Cable type optical fiber	Multimode optical fiber cable with 62.5 µm core diameter and 125 µm outer diameter			
USB	2x Ex-e and 2x Ex-i			
PS/2	For external I.S. keyboard (optional) or I.S. mouse (optional)			
Readers (option)	Connection for: Barcode scanner, Wiegand reader, Proximity reader			
Processor	Pentium M or ATOM up to 1.6 GHz			
Main memory [GB]	1 or 2			
Data memory [GB]	4, 8 or 16			
Data memory type	Compact-Flash card (Silicon Drive)			
Memory extension (optional)	Hard disc Exicom-SHD-xxx 60 GB or 120 GB			
Operating system	Windows XP Embedded Windows XP Professional			
Standard Software	WIN CC flexible, iFix, RSView (further Software solutions see Homepage)			
Global Language support	Via Multi-Language-Interface from Windows XP embedded (25 languages)			
Power supply	24 VDC (20.4 up to 28.8 VDC)			
Power consumption [A]	2.4	2.4	2.4	2.6
Connections	Via plug-in screw terminals, 2.5 mm ² green			
Housing	Stainless steel			
Front plate	Aluminum with polyester membrane or stainless steel, touch and safety glass			
Protection type	IP66 (according to EN 60529)			

Temperature range				
Cold start temperature	-10...+50°C **			
During operation	-20...+50°C **			
Operating with heater *	-30...+50°C **			
Operating with heater *, housing insulation and front cover	-40...+50°C **			
Storage temperature	-20...+60°C			
* Comment	The used heater must be construed in the way, that inside of the enclosure of the operator interface the temperature will NOT fall below -20°C (-30°C only front plate) !			
** Comment	For devices with ATOM processor +55 °C at a maximum of 6 hours (not for permanent operation) !			
Relative humidity	90% at 40 °C, without condensation			
Vibration				
Operation	3 bis 22Hz: 1mm 22 bis 500Hz: 9,8m/s ² = 1g			
Transport	3 bis 9Hz: 3,5mm 9 bis 500Hz: 9.8m/s ² = 1g			
Shock loading				
Operation	150m/s ² = ca. 15g / 11ms			
Transport	250m/s ² = ca. 25g / 6ms			
Dimensions [mm]				
Front (w x h)	400 x 270	372 x 270	440 x 340	535 x 425
Cut-out (w x h) (+/- 0.5)	385.5 x 257.5	359.5 x 257.5	427.5 x 327.5	522.5 x 412.5
Mounting depth	150	150	165	165
Wall thickness	8	8	8	8
Weight [kg]				
Operator interface	11.55	11.55	14.70	22.50
Fixing frame	0.6	0.6	0.7	0.85

5 Conformity to standards

The ET-4x6-Tx and ET-4x6-Fx operator interfaces comply with the following standards and directives:

Standard	Classification
Directive 94/9/EC	
5th Supplement	
EN 60079-0 : 2006	General requirements
EN 60079-1 : 2007	Flameproof enclosures "d"
EN 60079-7 : 2007	Increased safety "e"
EN 60079-11 : 2007	Intrinsic safety "i"
EN 60079-18 : 2004	Encapsulation "m"
EN 60079-28 : 2007	Optical radiation
EN 61241-0 : 2006	General requirements (dust)
EN 61241-1 : 2004	Protection by enclosures "tD" (dust)
Electromagnetic compatibility	
Directive 2004/108/EC	
EN 61000-6-2 (2005)	Immunity
EN 61000-6-4 (2007)	Emission

6 Certifications

The Open HMI operator interfaces have been approved for the following scopes:

By ATEX directive 94/9/EC

for installation in zones 1, 2, 21 und 22

DNV (Det Norske Veritas)

GOST-R (Russian certification)

UL INMETRO (Brazilian certification)

CNEX (Nanyang Explosion Protected Electrical Apparatus Research Institute – Chinese certification)

CKT (CAA JSC The National Center of Expertise and Certification Almaty Branch – Kazakh certification)

UL (Underwriters Laboratories)

6.1 ATEX

The ATEX certification is listed below the following number:

Certificate number:

TÜV 05 ATEX 7176 X

6.2 DNV

The DNV certification is listed below the following numbers:

Certificate number:

A-11822

File number:

899.60

Job Id:

262.1-001689-3

6.3 GOST-R

The GOST-R certification is listed below the following number:

Certificate number:

POCC DE.ГБ04.В01280

6.4 UL INMETRO

The UL INMETRO certification is listed below the following number:

Certificate number:

06/UL-BRCR-0001X

6.5 CNEX

The CNEX certification is listed below the following number:

Certificate number:

CNEx10. 1832X

6.6 CKT

The CKT certification is listed below the following numbers:

Certificate number:

KCC No 1018112

KZ.0.02.0317

KZ.7500317.01.01.14106

6.7 UL

The UL certification is listed below the following number:

UL File Number:

E202379

7 Product identification

Manufacturer	R. STAHL HMI Systems GmbH	
Type code	ET-4x6-Tx and ET-4x6-Fx	
CE classification:	CE 0158	
Testing authority and certificate number:	TÜV 05 ATEX 7176 X	
Ex-classification:		
ATEX-directive 94/9/EC		II 2 (2) G Ex d e mb ib [ib] [op is] IIC T4 II 2 D Ex tD A21 IP65 T90°C
GOST-R		2Exdemib[ib]sIICT4X DIP A21 TA90°C, IP65
UL INMETRO		BR-Ex d e mb ib [ib] IIC T4
CNEX		Exdemib[ib]IICT4 DIP A21 TA, T90°C
UL		Class I, Div. 2, Groups A, B, C, D Class II, Div. 2, Groups F, G Class III, hazardous locations Class I, Zone 2, Group IIC Temperature classification T4, enclosure type 1

8 Power supply

8.1 Operator interfaces

Power supply: 24.0 VDC (min. 20.4 VDC; max. 28.8 VDC)
Power consumption: max. 2.6 A

8.2 Reader modules

- a) WCR1 external power supply module with intrinsically safe power supply circuit and the following maximum values:
 $U_o = 12.4 \text{ VDC}$ $I_o = 200 \text{ mA}$
- b) RSi1 internal intrinsically safe power supply circuit
 $U_o = 10.4 \text{ VDC}$ $I_o = 220 \text{ mA}$

9 Permitted maximum values

9.1 External, non-intrinsically safe circuits

Input voltage (X1):

Rated voltage	24 VDC (+20% / -15%)
Power consumption for U_{rated}	2.4 A max

Max. operating voltage U_m	30 VDC
------------------------------	--------

RS-422/-232 COM 1 (X2):

Rated voltage	RS-422: 5 VDC	RS-232: ± 12 VDC
Max. operating voltage U_m	253 VAC	

RS-422/-232 COM 2 (X3):

Rated voltage	RS-422: 5 VDC	RS-232: ± 12 VDC
Max. operating voltage U_m	253 VAC	

USB-1 (X5):

Rated voltage	5 VDC
Max. operating voltage U_m	253 VAC

USB-3 (X7):

Rated voltage	5 VDC
Max. operating voltage U_m	253 VAC

Ethernet copper (X11):

Rated voltage	5 VDC
Rated power	100 mW
Max. operating voltage U_m	30 VDC

9.2 External inherently safe optical interface

Ethernet optical fiber (X10):

Wavelength	1350 nm
Radiant power	≤ 35 mW

9.3 External intrinsically safe circuits

USB-0 (X4):

The maximum values for group IIC are:

U_i	=	-	V		U_o	=	5.9	V					
I_i	=	-	mA		I_o	=	1.02	A					
P_i	=	-	mW		P_o	=	6.02	W					
C_i	=	0	μ F		C_o	=	8	13	30	43	μ F		
L_i	=	0	mH		L_o	=	10	5	2	1	μ H		

C_o and L_o pairs directly above/underneath each other may be used.

The maximum values for group IIB are:

U_i	=	-	V		U_o	=	5.9	V					
I_i	=	-	mA		I_o	=	1.02	A					
P_i	=	-	mW		P_o	=	6.02	W					
C_i	=	0	μ F		C_o	=	14	26	50	89	μ F		
L_i	=	0	mH		L_o	=	0.1	0.05	0.02	0.01	mH		

C_o and L_o pairs directly above/underneath each other may be used.

USB-2 (X6):

The maximum values for group IIC are:

U_i	=	-	V		U_o	=	5.9	V					
I_i	=	-	mA		I_o	=	1.02	A					
P_i	=	-	mW		P_o	=	6.02	W					
C_i	=	0	μ F		C_o	=	8	13	30	43	μ F		
L_i	=	0	mH		L_o	=	10	5	2	1	μ H		

C_o and L_o pairs directly above/underneath each other may be used.

The maximum values for group IIB are:

U_i	=	-	V		U_o	=	5.9	V					
I_i	=	-	mA		I_o	=	1.02	A					
P_i	=	-	mW		P_o	=	6.02	W					
C_i	=	0	μ F		C_o	=	14	26	50	89	μ F		
L_i	=	0	mH		L_o	=	0.1	0.05	0.02	0.01	mH		

C_o and L_o pairs directly above/underneath each other may be used.

Reader (X8) +Uint 1 (power supply circuit, X8.0):

The maximum values for group IIC are:

U_i	=	-	V		U_o	=	10.4	V
I_i	=	-	mA		I_o	=	220	mA
P_i	=	-	mW		P_o	=	2.29	W
C_i	=	-	μ F		C_o	=	2.41	μ F
L_i	=	-	mH		L_o	=	0.02	mH

The maximum values for group IIB are:

U_i	=	-	V		U_o	=	10.4	V
I_i	=	-	mA		I_o	=	220	mA
P_i	=	-	mW		P_o	=	2.29	W
C_i	=	-	μ F		C_o	=	12	μ F
L_i	=	-	mH		L_o	=	50	μ H

Reader WCR1 (connection voltage supply, X8.1–2):

The maximum values for group IIC are:

U_i	=	12.4	V		U_o	=	-	V
I_i	=	200	mA		I_o	=	-	mA
P_i	=	-	mW		P_o	=	-	mW
C_i	=	0	μ F		C_o	=	-	μ F
L_i	=	0	mH		L_o	=	-	mH

The maximum values for group IIB are:

U_i	=	12.4	V		U_o	=	-	V
I_i	=	200	mA		I_o	=	-	mA
P_i	=	-	mW		P_o	=	-	mW
C_i	=	0	μ F		C_o	=	-	μ F
L_i	=	0	mH		L_o	=	-	mH

Reader WCR1 (power supply Reader, X8.3-4):

The maximum values for group IIC are:

U_i	=	-	V		U_o	=	5.88	V
I_i	=	-	mA		I_o	=	200	mA
P_i	=	-	mW		P_o	=	1.18	W
C_i	=	4.6	μ F		C_o	=	28.4	μ F
L_i	=	100	nH		L_o	=	1.9	μ H

The maximum values for group IIB are:

U_i	=	-	V		U_o	=	5.88	V
I_i	=	-	mA		I_o	=	200	mA
P_i	=	-	mW		P_o	=	1.18	W
C_i	=	4.6	μ F		C_o	=	56.4	μ F
L_i	=	100	nH		L_o	=	19.9	μ H

Reader WCR1 (signal input / output, X8.5-8):

The maximum values for group IIC are:

U_i	=	15	V		U_o	=	5.88	V
I_i	=	500	mA		I_o	=	56	mA
P_i	=	2.5	W		P_o	=	83	mW
C_i	=	0	μ F		C_o	=	34	μ F
L_i	=	0	mH		L_o	=	2	μ H

The maximum values for group IIB are:

U_i	=	15	V		U_o	=	5.88	V
I_i	=	500	mA		I_o	=	56	mA
P_i	=	2.5	W		P_o	=	83	mW
C_i	=	0	μ F		C_o	=	63	μ F
L_i	=	0	mH		L_o	=	20	μ H

Reader RSi1 (connection voltage supply, X8.1–2):

The maximum values for group IIC are:

U_i	=	12.4	V		U_o	=	-	V
I_i	=	220	mA		I_o	=	-	mA
P_i	=	2.7	W		P_o	=	-	mW
C_i	=	0	μ F		C_o	=	-	μ F
L_i	=	0	mH		L_o	=	-	mH

The maximum values for group IIB are:

U_i	=	12.4	V		U_o	=	-	V
I_i	=	220	mA		I_o	=	-	mA
P_i	=	2.7	W		P_o	=	-	mW
C_i	=	0	μ F		C_o	=	-	μ F
L_i	=	0	mH		L_o	=	-	mH

Reader RSi1 (power supply Reader, X8.3–4):

The maximum values for group IIC are:

U_i	=	-	V		U_o	=	5.4	V
I_i	=	-	mA		I_o	=	220	mA
P_i	=	-	W		P_o	=	1.19	W
C_i	=	4.2	μ F		C_o	=	39.8	μ F
L_i	=	100	nH		L_o	=	1.9	μ H

The maximum values for group IIB are:

U_i	=	-	V		U_o	=	5.4	V
I_i	=	-	mA		I_o	=	220	mA
P_i	=	-	W		P_o	=	1.19	W
C_i	=	4.2	μ F		C_o	=	69.8	μ F
L_i	=	100	nH		L_o	=	19.9	μ H

Reader RSi1 (signal input / output, X8.5-8):

The maximum values for group IIC are:

U _i	=	15	V		U _o	=	5.4	V
I _i	=	500	mA		I _o	=	49	mA
P _i	=	2.5	W		P _o	=	62	mW
C _i	=	0	μF		C _o	=	45	μF
L _i	=	0	mH		L _o	=	2	μH

The maximum values for group IIB are:

U _i	=	15	V		U _o	=	5.4	V
I _i	=	500	mA		I _o	=	49	mA
P _i	=	2.5	W		P _o	=	62	mW
C _i	=	0	μF		C _o	=	78	μF
L _i	=	0	mH		L _o	=	20	mH

PS2 interface (X9):

Connection for keyboard, mouse, trackball, joystick

The maximum values for group IIC are:

U _i	=	-	V		U _o	=	5.9	V	
I _i	=	-	mA		I _o	=	200	mA	
P _i	=	-	mW		P _o	=	1.18	W	
C _i	=	14	μF		C _o	=	19	29	μF
L _i	=	0	mH		L _o	=	2	1	μH

C_o and L_o pairs directly above/underneath each other may be used.

The maximum values for group IIB are:

U _i	=	-	V		U _o	=	5.9	V			
I _i	=	-	mA		I _o	=	200	mA			
P _i	=	-	mW		P _o	=	1.18	W			
C _i	=	14	μF		C _o	=	13	23	46	86	μF
L _i	=	0	mH		L _o	=	100	50	20	10	μH

C_o and L_o pairs directly above/underneath each other may be used.



Please note !

- The terminal name for the keyboard as listed on the TÜV 05 ATEX 7176 X EC-type examination certificate is wrong !

"X7" is incorrect, the correct terminal name is X9 !



Do **NOT** connect the optional external keyboard to live equipment !

10 Type code

Exicom ET-xxx _____ 406 / 416 / 436 / 456

Order number supplement:

Ordering code	Description
	Type with
ET-4x6-Fx	Optical fiber 100 Base Fx (Ex op is) Ethernet interface
ET-4x6-Tx	Copper 10/100 Base Tx (Ex-e) Ethernet interface
ET-4x6-4GB	4 GB CF memory card
ET-4x6-8GB	8 GB CF memory card
ET-4x6-16GB	16 GB CF memory card
ET-4x6-60GB	60 GB hard disk (external)
ET-4x6-120GB	120 GB hard disk (external)
ET-436-HB	High Brightness Display 650 cd/m ² (ET-436 only)
ET-4x6-RSi	Plug-in module for reader with integrated decoder and RS-232 interface
ET-4x6-WCRi	Plug-in module for reader with Wiegand interface

10.1 Type code with ATOM processor

Exicom ET-xxx-AT-Rx-aaa-bb-cc-ddd

Front plate
 Memory
 Ethernet interface
 Display variant
 Main memory
 ATOM processor
 406 / 416 / 436 / 456

Product type:

Version	Description
	Type with
ET-xxx-AT	Basic device with ATOM processor
ET-xxx-AT-R1-aaa-bb-cc-ddd	Main memory 1 GB
ET-xxx-AT-R2-aaa-bb-cc-ddd	Main memory 2 GB
ET-xxx-AT-Rx-TFT-bb-cc-ddd	TFT Display (Standard)
ET-xxx-AT-Rx-SR-bb-cc-ddd	High Brightness Display 600 cd/m ² (ET-436 only)
ET-xxx-AT-Rx-aaa-Fx-cc-ddd	Optical fiber Ethernet interface 100BaseFx (Ex op is)
ET-xxx-AT-Rx-aaa-Tx-cc-ddd	Copper Ethernet interface 10/100BaseTx (Ex-e)
ET-xxx-AT-Rx-aaa-bb-4GB-ddd	4 GB CF memory card
ET-xxx-AT-Rx-aaa-bb-8GB-ddd	8 GB CF memory card
ET-xxx-AT-Rx-aaa-bb-16GB-ddd	16 GB CF memory card
ET-xxx-AT-Rx-aaa-bb-60GB-ddd	60 GB hard disk (external)
ET-xxx-AT-Rx-aaa-bb-120GB-ddd	120 GB hard disk (external)
ET-xxx-AT-Rx-aaa-bb-cc-PES	Frontplate polyester
ET-xxx-AT-Rx-aaa-bb-cc-VA	Frontplate stainless steel
ET-xxx-RS	Module for reader unit with integrated decoder and RS-232 interface
ET-xxx-WCR	Module for reader unit with Wiegand interface
ET-4x6-xx-UL	Operator interface with UL certification (May ONLY be used in ATEX areas with cable glands instead of Conduit Hubs !) *

* See note in section "UL certification" !

11 Safety Advice

This chapter is a summary of the key safety measures. The summary is supplementary to existing rules which staff also have to study.

The safety of persons and equipment in hazardous areas depends on compliance with all relevant safety regulations. Thus, the installation and maintenance staff carry a particular responsibility, requiring precise knowledge of the applicable regulations and conditions.

11.1 Installation and operation

Please note the following when installing and operating the device:

- Only operator interfaces with UL certification may be installed and operated in areas covered by the NEC (see chapter "UL certification") !
In areas covered by ATEX, this device may **ONLY** be installed and operated if the two Conduit Hub connections have been replaced by conventional cable glands !
- During assembly and operation of the operator interface electrostatic surface charging must not exceed that caused by manual rubbing.
- The national regulations for installation and assembly apply (e.g. EN 60079-14).
- The operator interfaces may be installed in zones 1, 2, 21 or 22.
- The intrinsically safe circuits must be installed according to applicable regulations.
- The operator interface must only be switched on when it is closed.
- When installed in zones 1, 2, 21 and 22, intrinsically safe devices suitable for zones 1, 2, 21 and 22 may be connected to the intrinsically safe power supply circuits.
- The safe maximum values of the connected field device(s) must correspond to the values listed on the data sheet or the EC type examination certificate.
- Interconnecting several active devices in an intrinsically safe circuit may result in different safe maximum values. This could compromise intrinsic safety !
- After switching the operator interface off, wait for at least 1 minute before opening it.
- Before opening the housing lid users must ensure that all non-intrinsically safe circuits have been switched off. Circuits supplied from different sources may be connected !
Please note that all associated equipment (such as the SK-KJ1710, for example) must also be switched off !
- National safety and accident prevention rules.
- Generally accepted technical rules.
- Safety instructions contained in these operating instructions.
- Any damage may compromise the explosion protection !

Use the operator interface for its intended purpose only (see "Function").

Incorrect or unauthorized use and non-compliance with the instructions in this manual will void any warranty on our part.

No changes may be made to the operator interface or its components that compromise explosion protection !

The operator interface may only be installed and operated in an undamaged condition !

11.2 Special conditions

- The housing of the operator interface must be protected against prolonged UV radiation.
- The operator interface and any connected equipment must be incorporated into the same potential equalization system (see installation example in the Hardware Manual). An alternative would be to connect only devices that are safely isolated from earth potential.

11.3 Installation via USB interfaces

Installation of software on the operator interfaces:

11.3.1 Software installation using a USB Memory Stick

You may only use USB memory sticks permitted for use by R. STAHL HMI Systems GmbH. These USB memory sticks are below and in general referred to by R. STAHL HMI Systems GmbH as "USB(i) Drives". Data may only be copied onto the operator interfaces and software may only be installed with these USB Drives.

- In hazardous areas you may only use I.S. certified USB Drives supplied by R. STAHL HMI Systems GmbH.
- In an industrial area, a permitted, non-explosion proof memory stick may be connected to the I.S. USB interface of the operator interface after having been connected to any PC.
- R. STAHL HMI Systems GmbH's USB(i) drives may also be connected to non-intrinsically safe interfaces and can be used with the ET-4x6 series operator interfaces when connected to such interfaces.

If devices are connected to the I.S. USB interface that have not been approved by R. STAHL HMI Systems GmbH, protective elements may become damaged, thus compromising the intrinsic safety of the interfaces.

In this case R. STAHL HMI Systems can no longer guarantee the intrinsic safety of the device !

11.3.2 Software installation with external USB devices

Software may be installed with the aid of any external USB devices subject to the following conditions:

- The software is installed in the safe area.
- The USB devices are connected to the Ex-e USB interfaces USB1 or USB3 (X5 or X7) with the VB-USB-INST1 connection cable.

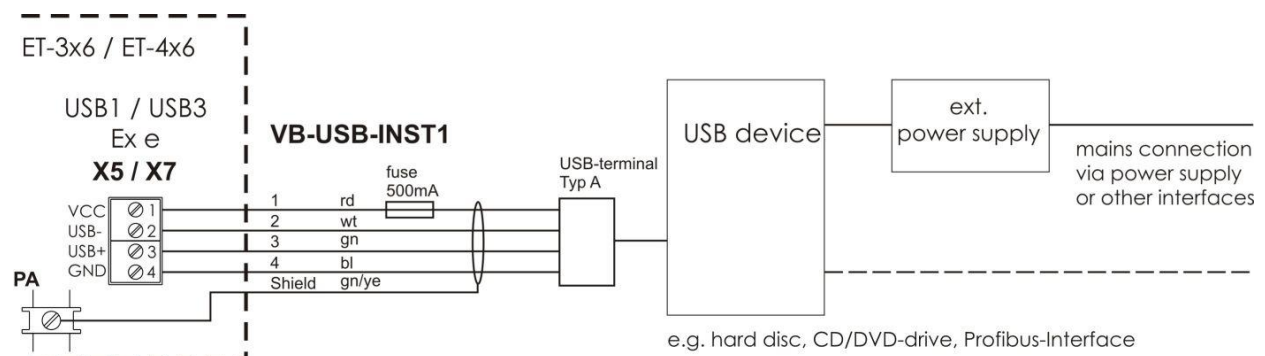

Connection diagram with VB-USB-INST1 (hard disk, CD/DVD with power supply)

11.4 USB interfaces

The ET-4x6 operator interfaces have 4 USB interface channels.

- USB0 at X4 for the internal connection of a USB Drive.
- USB1 at X5 for the connection of external USB devices.
- USB2 at X6 for the connection of an external USB Drive.
- USB3 at X7 for the connection of external USB devices.

 The connection diagram for the ET-4x6 interfaces can be found in [Chapter 15.2, connections ET-4x6](#)

11.4.1 I.S. USB interfaces USB0, USB2

The USB0 and USB2 I.S. USB interfaces (X4 and X6) are intended for the internal or external connection of USBi Drives.

The maximum value for the joint power supply of USB0 and USB2 is 500 mA.

11.4.2 Ex-e USB interfaces USB1, USB3

The USB1 and USB3 Ex-e USB interfaces (X5 and X7) are intended for the connection of external USB devices.

The maximum value for the joint power supply of USB1 and USB3 is 500 mA.

11.4.2.1 Connection variations for Ex-e USB interfaces

The two Ex-e USB interfaces have an identical structure. The X5 (USB 1) and X7 (USB 3) terminals are for the connection of devices that can be both intrinsically safe or not intrinsically safe.

 If intrinsically safe devices are connected to the Ex-e USB interfaces of the ET-4x6 operator interfaces, R. STAHL HMI Systems GmbH can no longer guarantee the intrinsic safety of these devices !

The following versions are possible:

1. If a USB device that is not connected to the mains is connected, voltage can be supplied from the internal power supply (terminal 1).
 2. If a USB device that is connected to the mains is connected, the internal power supply (terminal 1) must not be connected. The power must then be supplied externally.
- The interrupting capacity of the fuses of the internal USB power supplies is 1.5 kA.
 - The tripping characteristic of the fuses is T (time-lag, type T fuse).
 - The USB accessory parts are fitted inside an appropriate housing.

11.4.2.2 Connection terminal of protection type "e" (EN 60079-7)

The X5 and X7 connection terminals have protection type "e".

Flexible cables with a cross section of 0.2 – 2.5 mm² can be used.

The maximum cable length for the connection with the Ex-e USB interfaces (X5 and X7) is 2.5 m.

The insulation of the wire must reach right up to the terminal body.

11.4.2.2.1.1 Type 1 connection version

- The USB device does not require an external power supply as it uses less than 500 mA.
- No connection to the mains via other interfaces, e.g. WLAN stick.

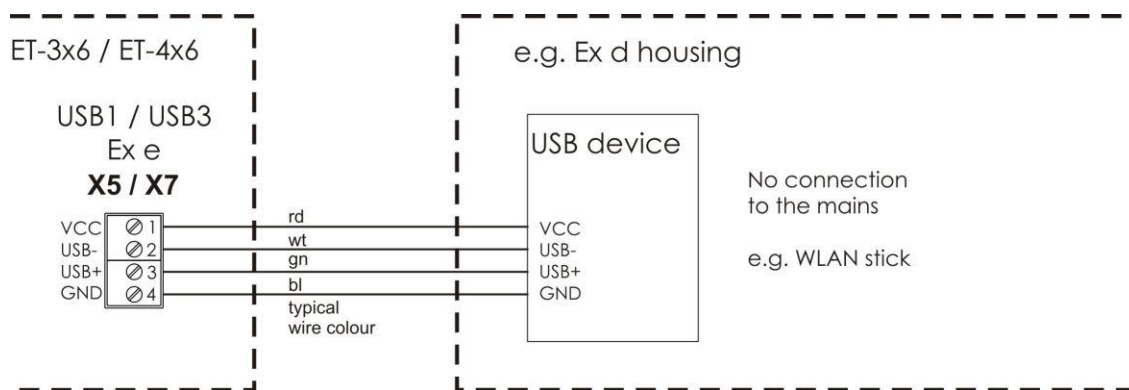

Type 1 connection diagram (e.g. WLAN stick)

11.4.2.2.2 Type 2 connection version

- The USB device does require an external power supply to function because it uses over 500 mA, e.g. hard disks, CD/DVD drives.
- The USB device is connected to the mains via other interfaces, e.g. USB/serial converter, USB-Profibus interface.

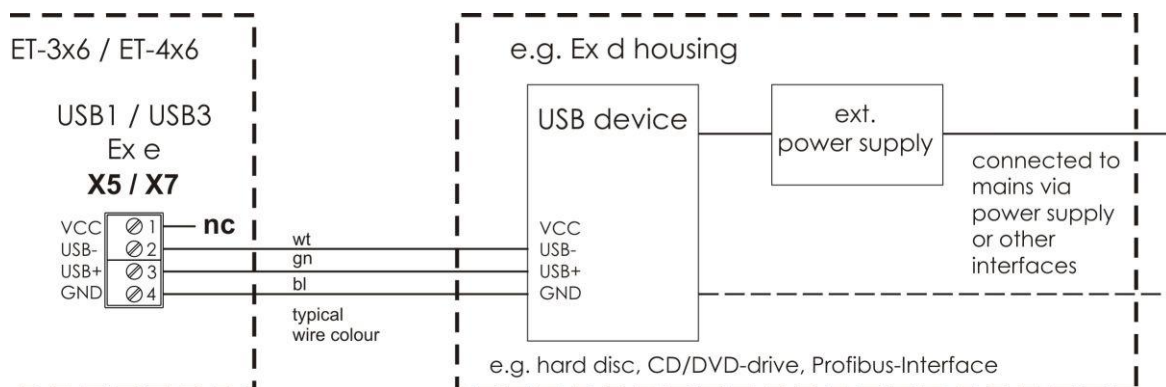

Type 2 connection diagram (e.g. hard disk, CD/DVD with power supply)

11.4.2.2.3 Type 3 connection version

- The USB device does require an external power supply to function because it uses over 500 mA, e.g. hard disks, CD/DVD drives.
- The USB device is connected to the mains via other interfaces, e.g. USB/serial converter, USB-Profibus interface.
- The USB device needs the VCC connection of the operator interface (internal supply – terminal 1) to function.

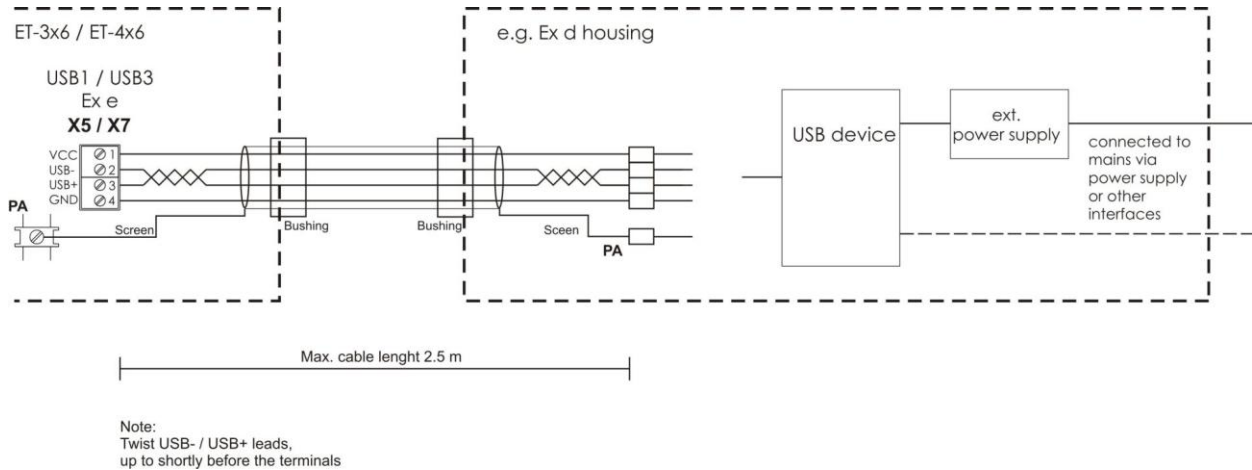

Type 3 connection diagram (any USB device with power supply)

12 Hard disk Exicom-SHD-xxx

The optional hard disk Exicom-SHD-xxx can be mounted inside of the operator interfaces ET-4x6-Tx and ET-4x6-Fx.

☞ Please specify when ordering if and which hard disk version you like to use.

Separate operating instructions for the hard disk Exicom-SHD-xxx are available.

12.1 Installation of hard disk

The installation of the hard disk Exicom-SHD-xxx is done during the manufacturing of the operator interfaces at R. STAHL HMI Systems GmbH. Any subsequent installation of the hard disk Exicom-SHD-xxx into the operator interfaces is **NOT** possible !

12.2 Warnings

⚠ The Exicom operator interfaces ET-4x6-Tx and ET-4x6-Fx may **NOT BE OPERATED WITHOUT HARD DISK** or **DISCONNECTED** SATA-connection cabel !
Therefor is a warning label at the SATA-connection cabel of the hard disk Exicom-SHD-xxx.

⚠ It is **NOT ALLOWED TO DISCONNECT** the SATA- and the power supply connection of the hard disk Exicom-SHD-xxx from the operator interface **WHILE ENERGIZED** !
Also therefor is a warning label at the hard disk Exicom-SHD-xxx.

12.3 Changing of hard disk

The hard disk Exicom-SHD-xxx may be exchanged. This exchange is only allowed by qualified and authorized staff with knowledge in explosion protection !

⚠ Please note the instructions and advices for the exchange of the hard disk Exicom-SHD-xxx written in the operating instructions anyway !

13 Installation

13.1 General information

Electrical installations are subject to the relevant regulations for installation and operation, such as RL 1999/92/EC, RL 94/9/EC und IEC/EN 60079-14.

The operators of electrical installations in hazardous environments must ensure that the equipment is kept in proper condition, is operated according to instructions and that maintenance and repairs are carried out.

13.2 ET-4x6-Tx, ET-4x6-Fx

- The operator interfaces may be installed in zones 1, 2, 21 or 22. The intrinsically safe circuits must be installed according to applicable regulations.
- Intrinsically safe and non intrinsically safe conducting connection parts must be installed with a minimum distance of 50 mm.
- Operators must ensure compliance with the EC type examination certificates before installation. Users must adhere to any "special conditions" therein. Also of importance are the maximum electrical operating values specified therein.
- When connecting the operator interfaces to the intrinsically safe circuits of the associated equipment the respective maximum values of the field unit and the associated equipment must be observed to ensure explosion protection (proof of intrinsic safety).
- The earth/ground (PA) connector at the back of the operator interface housing must be connected to the equipotential bonding conductor of the hazardous area. To prevent equalizing currents flowing to the earth/ground (PA) system of the operator interface it is necessary to safely isolate any connected devices from earth or to integrate them into the earth/ground (PA) system of the operator interface.
- The PA connector of the operator interface, located at the back of the housing, is internally connected to the GND supply cable (X1, pins 3 and 4).
- Ex-e terminal blocks may be mounted inside the connection box of the housing (**NOT** NEC). They can, for example, serve as a sub-distribution unit for supply and signal lines of accessories mounted in separate housings and connected to the Exicom device's interfaces. These terminal blocks are installed during production of the operator interface. Customers must not attempt to mount the blocks into the devices themselves.
- The operator interface's front should be protected by a canopy against permanent exposure to UV light. This increases the front membrane's lifespan. The canopy **MUST NOT** be too close to the front plate and sufficient air circulation must be ensured.

14 Assembly and disassembly

14.1 General information

Assembly and disassembly are subject to general technical rules. Additional, specific safety regulations apply to electronic and pneumatic installations.

14.2 Cut-out ET-4x6

Make a cut-out with the following dimensions:

Operator interface	Width	Height	Depth of cut-out	Material thickness
ET-406	385.5 ± 0.5 mm	257.5 ± 0.5 mm	150 mm	up to 8 mm
ET-416	359.5 ± 0.5 mm	257.5 ± 0.5 mm	150 mm	up to 8 mm
ET-436	427.5 ± 0.5 mm	327.5 ± 0.5 mm	165 mm	up to 8 mm
ET-456	522.5 ± 0.5 mm	412.5 ± 0.5 mm	165 mm	up to 8 mm

15 Operation

15.1 General information

When operating the devices, particular care shall be taken that:

- the operator interface has been properly installed according to instructions,
- the device is undamaged,
- the terminal compartment is clean,
- all screws are tightened fast,
- the screws on the cable inlets are tightened fast,
- before switching the operator interface on, its external bonding terminal (PA-connector) is properly connected to the equipotential bonding system at its place of use,
- the cover of the terminal compartment is completely closed.

15.2 Connections ET-4x6

Terminal	Pin	Definition	Connection
X1	1	Power supply operator interface +24 VDC	Power supply of the operator interface
	2	Power supply operator interface +24 VDC	
	3	Power supply operator interface GND	
	4	Power supply operator interface GND	
X2	1	TxD-b	Serial COM1 interface RS-422/485
	2	TxD-a	
	3	RxD-b	
	4	RxD-a	
	5	TxD-b'	
	6	TxD-a'	
	7	RxD-b'	
	8	RxD-a'	
	9	TxD	Serial COM1 interface RS-232
	10	RxD	
	11	RTS/	
	12	CTS/	
	13	GND	
X3	1	TxD-b	Serial COM2 interface RS-422/485
	2	TxD-a	
	3	RxD-b	
	4	RxD-a	
	5	TxD-b'	
	6	TxD-a'	
	7	RxD-b'	
	8	RxD-a'	
	9	TxD	Serial COM2 interface RS-232
	10	RxD	
	11	RTS/	
	12	CTS/	
	13	GND	
X4		USB interface, connection type A	USB0 I.S.
X5	1	VCC	USB1 Ex-e
	2	USB -	
	3	USB +	
	4	GND	
X6	1	VCC	USB2 I.S.
	2	USB -	
	3	USB +	
	4	GND	
	5	GND	
X7	1	VCC	USB3 Ex-e
	2	USB -	
	3	USB +	
	4	GND	

X8	0	+U_INT1	Reader interface I.S.
	1	0V	
	2	+U_EX1	
	3	GND	
	4	+U_RD	
	5	Signal 1	
	6	Signal 2	
	7	Signal 3	
	8	Signal 4	
	9	+U_EX1 (out)	
X9	1	VCC	PS2 interface * I.S. for external keyboard / mouse
	2	KBDAT	
	3	KBCLK	
	4	MSDAT	
	5	MSCLK	
	6	GND	
X10	1	Optical fiber connection type SC	Ethernet optical fiber interface **
X11	1	TxD (+)	Ethernet copper connection **
	2	TxD (-)	
	3	RxD (+)	
	4	RxD (-)	

- ☞ Please also note that the COM interfaces may only be physically connected once !
The interconnection is either with a physical RS-232 or an RS-422/485 connection.
- ☞ * Do **NOT** connect the optional external keyboard to live equipment !
- ☞ ** Please note that the Ethernet connection is **either** for an optical fiber connection (X10) **or** for a copper connection (X11), depending on the version ordered !
For the optical fiber connection you have to use an multimode optical fiber cable with 62.5 µm core diameter and 125 µm outer diameter.
Cables connected to the Ethernet terminals (X11) must have a minimum cross section of 0.2 mm² (metrically) (AWG 24).
Which cable cross sections are chosen should be decided on the basis of relevant regulations, such as DIN VDE 0298. Factors that might require a larger cross section, such as current, increased temperatures, cable bundling, etc. must also be taken into account.

15.2.1 Dip switch settings S3 and S4

Switch	Position	Interface	Function
S3-1	OFF	COM1 RS-422/485	No bus terminator resistor set
	ON		Bus terminator resistor TxD line
S3-2	OFF		No bus terminator resistor set
	ON		Bus terminator resistor RxD line
S4-1	OFF	COM2 RS-422/485	No bus terminator resistor set
	ON		Bus terminator resistor TxD line
S4-2	OFF		No bus terminator resistor set
	ON		Bus terminator resistor RxD line

15.3 Connections Ex-e terminals (X12)

Up to 8 Ex-e terminal blocks may be mounted inside the connection box of the housing (**NOT** NEC). Because these terminal blocks are exclusively mounted during production, this option must be specified when ordering the product.

For devices with these optional terminal blocks, please note the following:

- Either Ex-e or I.S. circuits may be connected to these terminal blocks !



Ex-e or I.S. circuits **MUST NOT** be connected at the same time on terminal block X12.



When connecting cables please ensure that the cable isolation goes right up to the terminal part.

15.3.1 Labeling I.S. circuits

If intrinsically safe circuits are connected at terminal bar X12, all of these terminals and circuits must be marked uniquely and clearly visible, according to EN 60079-11. If a color is used for the marking, this has to be light blue.

15.3.2 Connection details of the I.S. terminals

Intrinsically safe circuits with the following safe maximum values may be connected to terminal block X12:

$$U = 30 \text{ V}$$

$$I = 5 \text{ A}$$

15.3.3 Connection details of the Ex-e terminals

For the alternatively permitted connection of Ex-e circuits the following maximum values apply:

- Maximum nominal voltage: 275 V
- Maximum nominal voltage:
(if the fixed bridge bar is used): 175 V
- Rated current: 4 A
- Maximum load current: 5 A

15.3.4 Cable types and cross sections

Copper cables with the following cross sections may be used:

- Maximum cable cross section in mm² (AWG) 4 (12)
- Minimum cable cross section in mm² (AWG) 0,2 (24)

Multiple cable connection to the screw terminal (2 cables of the same cross section and cable type):

- flexible mm² (AWG) 0,2 – 1,5 (24 – 16)
- rigid mm² (AWG) 0,2 – 1,5 (24 – 16)

Which cable cross sections are chosen should be decided on the basis of relevant regulations, such as DIN VDE 0298. Factors that might require a larger cross section, such as current, increased temperatures, cable bundling, etc. must also be taken into account.

16 Maintenance, service

Associated equipment is subject to maintenance, service and testing according to guidelines 1999/92/EC, IEC 60079-19, EN 60079-17 and BetrSichVer !

Because the transmission of the devices remains reliable and stable over long periods of time, regular adjustments are not required.

The following general principles apply for repairs *, purchase of spare parts * or exchange of parts *, where these may be carried out by the user:

- Only original parts provided by the manufacturer must be used.
- Fuses may only be replaced by equivalent fuse types.



* Please also note [Section 17 Troubleshooting](#) !

The Open HMI series operator interfaces have no batteries and are thus maintenance-free during their entire life cycle.

If Open HMI devices are in storage for longer than six months they should be operated for at least an hour at room temperature (20°C ± 5°C) every six months.

System maintenance should focus on the following:

- a. Seal wear
- b. Screen damage
- c. All screws are tightened fast
- d. All cables and lines are properly connected and undamaged

16.1 Servicing

In accordance with IEC 60079-19 and EN 60079-17, operators of electric plants in hazardous areas are obliged to have them serviced by qualified electricians.

16.2 Time function

A capacitor ensures the continuation of the time function while the Open HMI operator interfaces are switched off. The capacitor can keep up the time function for about five days while the device is switched off. If the device is switched back on later than after an interval of five days, the time has to be reset/synchronized manually or via another, connected system/server.

17 Troubleshooting

Devices operated in hazardous areas must not be modified. Repairs may only be carried out by qualified, authorized staff specially trained for this purpose.



Repairs may only be carried out by specially trained staff who are familiar with all basic conditions of the applicable user regulations and have been authorized by the manufacturer.

18 Disposal

Disposal of packaging and used parts is subject to regulations valid in whichever country the device has been installed.

The disposal of devices sold after August 13th, 2005, and installed in countries under the jurisdiction of the EU is governed by directive 2002/96/EC on waste electrical and electronic equipment (WEEE). Under this directive, operator interfaces are listed in category 9 (monitoring and control instruments).

We shall take back our devices according to our General Terms and Conditions.

18.1.1 ROHS directive 2002/95/EC

The prohibition of hazardous substances as detailed in directive 2002/95/EC (ROHS) does not apply to electronic equipment of categories 8 and 9, and is therefore not applicable to the equipment described in these operating instructions.

18.1.2 China ROHS labeling

According to new Chinese legislation in force since 01.03.2007, all devices containing hazardous substances must be labeled accordingly.

For our operator interfaces, the following conditions apply:

Names and contents of toxic or hazardous substances or elements:

Part Name	Toxic or hazardous substances and elements					
	Lead (Pb)	Mercury (Hg)	Cadmium (Cd)	Hexavalent Chromium (Cr (VI))	Poly- brominated biphenyls (PBB)	Poly- brominated diphenyl ethers (PBDE)
Housing	O	O	O	O	O	O
Display	O	O	O	O	O	O
all PCBs	X	O	O	O	O	O
Miscellaneous	O	O	O	O	O	O

O Indicates that this toxic or hazardous substance contained in all of the homogeneous materials for this part is below the limit requirements in SJ/T11363-2006.

X Indicates that this toxic or hazardous substance contained in at least one of the homogeneous materials for this part is below the limit requirements in SJ/T11363-2006.

19 Front panel resistance

This section contains information on the resistance of the operator interfaces to various environmental factors. These have an impact on the mechanical, thermal and chemical stability of the operator interfaces.

The resistance to chemicals was tested according to DIN 42115 Part 2, i.e. the stability over 24 hours without visible changes to the operator interfaces.

19.1 Design

Structure:

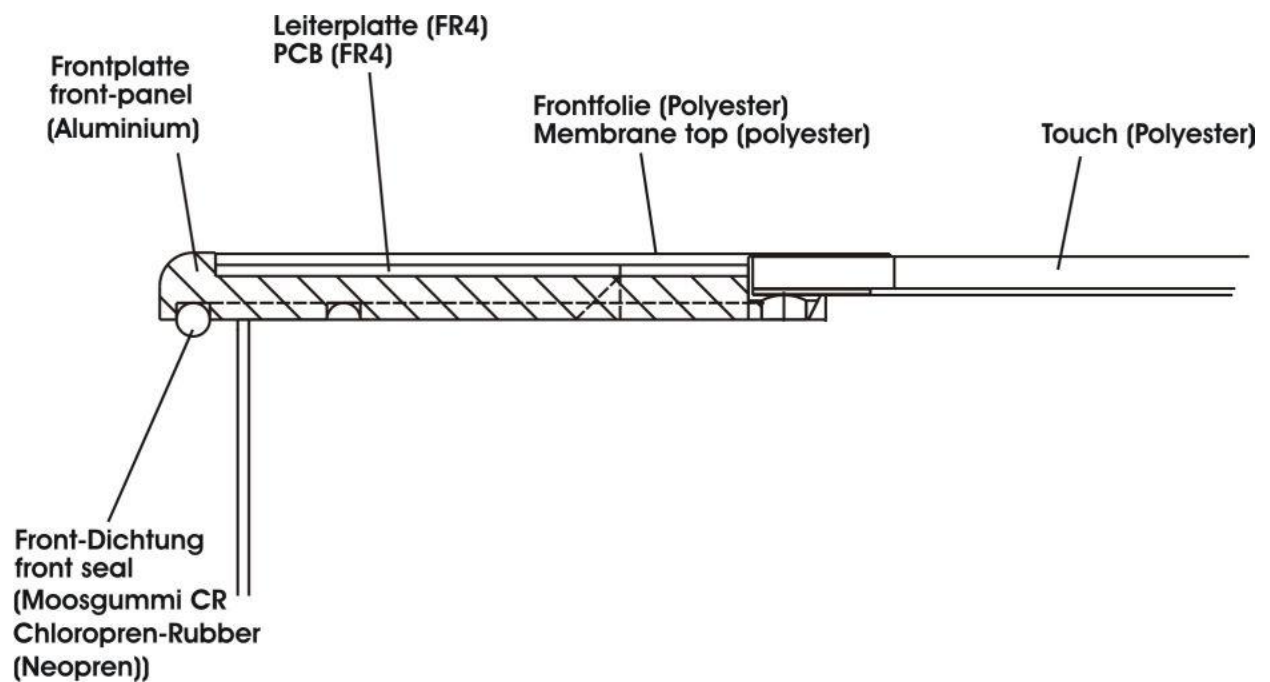
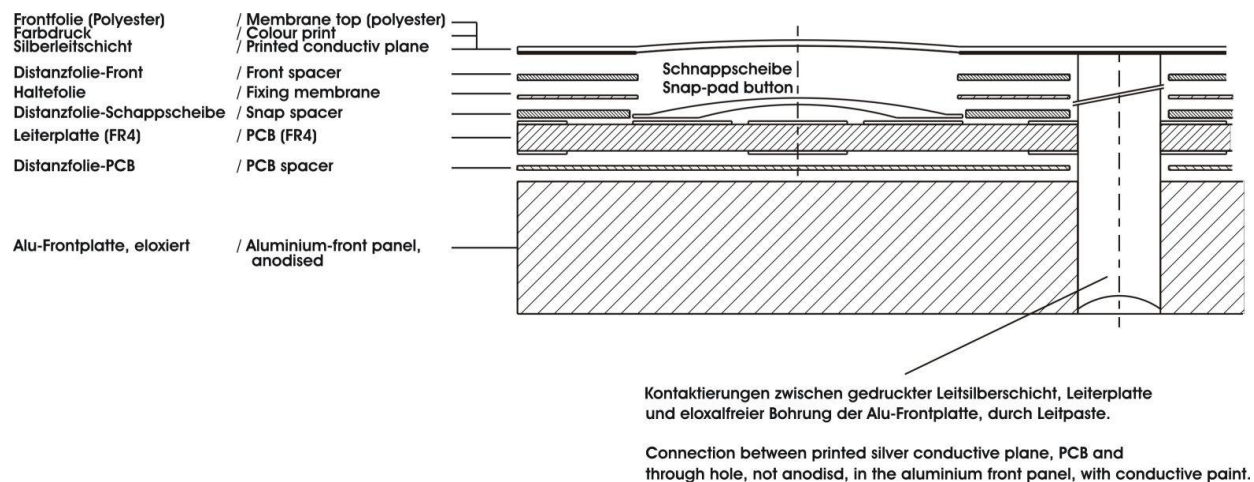

Diagram:



19.2 Materials

Application	Material
Membrane top	Polyester
Touch screen	Polyester / safety glass
PCB	FR4
Front plate	Aluminum
Housing	Stainless steel
Front panel seal	Chloropren-Rubber (Neopren)

19.3 Material properties

- ☞ The selection of chemicals listed here is not exhaustive.
- ☞ More comprehensive lists can be obtained for further information from R. STAHL HMI Systems GmbH.
- ☞ Because of the numerous chemical substances available on the market, these lists can only represent a selection.
- ☞ Further information can also be found on the following homepage:
<http://macdermidautotype.com/>

19.3.1 Entire device

- ☞ The chemical substances and resistances are the lowest common denominator of all materials used in the operator interface.
 Thus, the entire device has a somewhat lower chemical resistance than the individual materials.

Property	Chemical material class / group	Chemical substances	Test method
Chemical • Chemical resistance	Alcohols	Ethanol Methanol Glycerin	DIN 42115 DIN 53461
	Amines	Ammonia <2%	
	Ketones	Acetone	
	Diluted acids	Acetic acid <5%	
	Diluted alkaloids (bases)	Caustic soda <2%	
	Household chemicals	Detergents	
Property	Resistance		Test method
Mechanical • Service life after imprint • MIT folding resistance	5 million touches >20000 folding operations		Autotype method ASTM D2176
Thermal • Dimensional • Dimension stability	Max. 0.2% at 120° longitudinal Typically 0.1%		Autotype method

- ☞ Polyester films have a limited resistance against UV light and should therefore not be exposed to sunlight for longer periods.

19.3.2 Membrane top

Property	Chemical material class / group	Chemical substances	Test method
Chemical • Chemical resistance	Alcohols	1,3 Butanediol 1,4 Butanediol Cyclohexanol Diacetone alcohol Ethanol Glycol Glycerol Isopropyl alcohol Methanol Neopentyl glycol Octanol 1,2 Propylene glycol Triacetin Dowanol DRM/PM	DIN 42115 DIN 53 461 Oder ASTM-F-1598-95
	Aldehydes	Acetaldehyde Formaldehyde 37-42%	
	Amines	Ammonia < 2%	
	Esters	Amyl acetate Ethylacetate N-Butyl acetate	
	Ethers	1.1.1. Trichloroethane Ether Dioxane Diethyl ether 2-Methyltetrahydrofuran (2-ME-THF)	
	Aliphatic hydrocarbons		
	Aromatic hydrocarbons	Benzene Toluene Xylene Paint thinner (white spirit)	
	Ketones	Acetone Methyl ethyl ketone Cyclohexanone Methyl isobutyl ketone (MIBK) Isophorone	
	Diluted acids	Formic acid <50% Acetic acid < 5% Phosphoric acid <30% Hydrochloric acid <10% Nitric acid <10% Trichloroacetic acid <50% Sulfuric acid <30%	
	Diluted alkaloids (bases)	Caustic soda <40%	

Household chemicals	Ajax Ariel Domestos Downey Fantastic Formula 409 Gumption Jet Dry Lenor Persil Tenside Top Jop Vim Vortex Washing powder Fabric conditioner Whis Windex
Oils	Petrol Drilling muds Braking fluid Decon foam Diesel oil Varnish Keroflux Paraffin oil Castor oil Silicone oil Solvent naphta Mineral turpentine Kerosene
No specific material class	Acetonitrile Alkali carbonate Dichromates Potassium dichromate Caustic soda <20% Dibutyl phthalate Dioctyl phthalate Iron II chloride (FeCl ₂) Iron III chloride (FeCl ₃) Haloalkanes Potassium soap Potassium hydroxide <30% Sodium bisulfate Tetrachloroethylene Salt water Trichloroethylene Water Hydrogen peroxide <25%

Property	Resistance	Test method
Mechanic (keyboard) <ul style="list-style-type: none"> • Service life after imprint • MIT folding resistance 	5 million touches >20000 folding operations	Autotype method ASTM D2176
Mechanic (touch screen) <ul style="list-style-type: none"> • point activation 	1 million activations at any single point	3M method
Thermal <ul style="list-style-type: none"> • Dimensional • Dimension stability 	Max. 0.2% at 120° longitudinal Typically 0.1%	Autotype method

☞ Polyester films have a limited resistance against UV light and should therefore not be exposed to sunlight for longer periods.

19.3.3 Display / Touch screen

Polyester:

Property	Chemical material class / group	Chemical substances	Test method
Chemical <ul style="list-style-type: none"> • Chemical resistance 	(see front membrane)	(see front membrane)	(see front membrane)
Property	Resistance		Test method
Mechanical <ul style="list-style-type: none"> • Service life after imprint • MIT folding resistance 	(see front membrane)		(see front membrane)
Thermal <ul style="list-style-type: none"> • Dimensional • Dimension stability 	(see front membrane)		(see front membrane)

19.3.4 Front panel seal

Property	Chemical material class / group	Chemical substances	Test method
Chemical <ul style="list-style-type: none"> • Chemical resistance 	Alcohols	Methanol Glycerol	DIN 53461
	Amines	Ammonia	
	Ketones	Acetone	
	Diluted acids	Formic acid Acetic acid Hydrochloric acid Nitric acid <10%	
	Diluted alkaloids (bases)	Sodium hydroxide	
	Household chemicals	Detergents	
	Property	Resistance	
Mechanical	(No information available at present)		
Thermal <ul style="list-style-type: none"> • Installation area 	-30 to 100°C		DIN 53461

20 UL Certification

20.1 General information

Only Open HMI devices with the UL certification may be installed and operated in countries covered by the NEC.

☞ Operator interfaces for installation in countries covered by the NEC have separate ordering numbers (see type code). Please state these when ordering.

⚠ In areas covered by ATEX, an operator interface with UL certification may **ONLY** be installed and operated if the two Conduit Hub connections have been replaced by conventional cable glands !
To this end, the delivery of operator interfaces with UL certification includes two cable glands.

The Open HMI devices with the UL certification may be installed in the following hazardous areas:

- Class I, Division 2, Groups A, B, C, D
- Class II, Division 2, Groups F and G
- Class III, hazardous locations
- Class I, Zone 2, Group IIC
- Temperature classification T4, enclosure type 1

as defined by the NEC, or in non-hazardous areas.

☞ Before installation and operation of the Open HMIs users **MUST** refer to Control Drawing No. 2010 11 7000 0 !

20.2 Safety Advice

Before switching on the Open HMI devices and associated equipment, its external equipotential bonding terminal must be properly connected to the equipotential bonding system at its place of installation.

As an alternative, you may connect devices to the Open HMIs that have been safely disconnected from the earth potential.

20.2.1 Caution

⚠ Non-observance of this safety advice may lead to an explosion !

- The substitution of any component of the Open HMI devices may affect safety in hazardous areas and is therefore **NOT** permitted.
- Connected equipment must **NOT** be disconnected from the operator interface when still live, except if the environment is known to be free of ignitable concentrations.

20.3 Permitted maximum values

20.3.1 Electrical

Power supply (X1):

Vnominal	=	24.0 VDC (min. 20.4 VDC; max. 28.8 VDC)
Vmax	=	30 VDC
I _{max}	=	2.4 A

Interfaces RS-232, RS-422 and RS-485 (X2, X3):

RS-422, RS-485:	V _{nom}	=	5 VDC, V _{max}	=	253 VAC
RS-232:	V _{nom}	=	±12 VDC, V _{max}	=	253 VAC

Memory Stick USBi Drive (X4), USB interface (X6)

Entity parameters for nonincendive field wiring:

V _{oc}	=	5.9 V			
I _{sc}	=	1.02 A			
P _o	=	6.02 W			
C _a	=	8 μF	13 μF	30 μF	43 μF
L _a	=	10 μH	5 μH	2 μH	1 μH

The capacitances (C_a) and inductances (L_a) that are right underneath each other are associated pairs.

USB interfaces (X5, X7):

V _{nom}	=	5 VDC
V _{max}	=	253 VAC

PS2 interface (X9):

Entity parameters for nonincendive field wiring:

V _{oc}	=	5.9 V			
I _{sc}	=	200 mA			
P _o	=	1.18 W			
C _a	=	19 μF	29 μF		
L _a	=	2 μH	1 μH		

The capacitances (C_a) and inductances (L_a) that are right underneath each other are associated pairs.

LAN optical fibre (X10):

Wavelength	=	1350 nm
Radiant power	≤	35 mW

LAN copper cable (X11):

V _{nom}	=	5 VDC
P _{nom}	=	100 mW

20.3.2 Temperature range

-20°C up to + 50°C

20.4 Device with UL certification

Back view:

Example for placement of cable glands in accordance to UL:

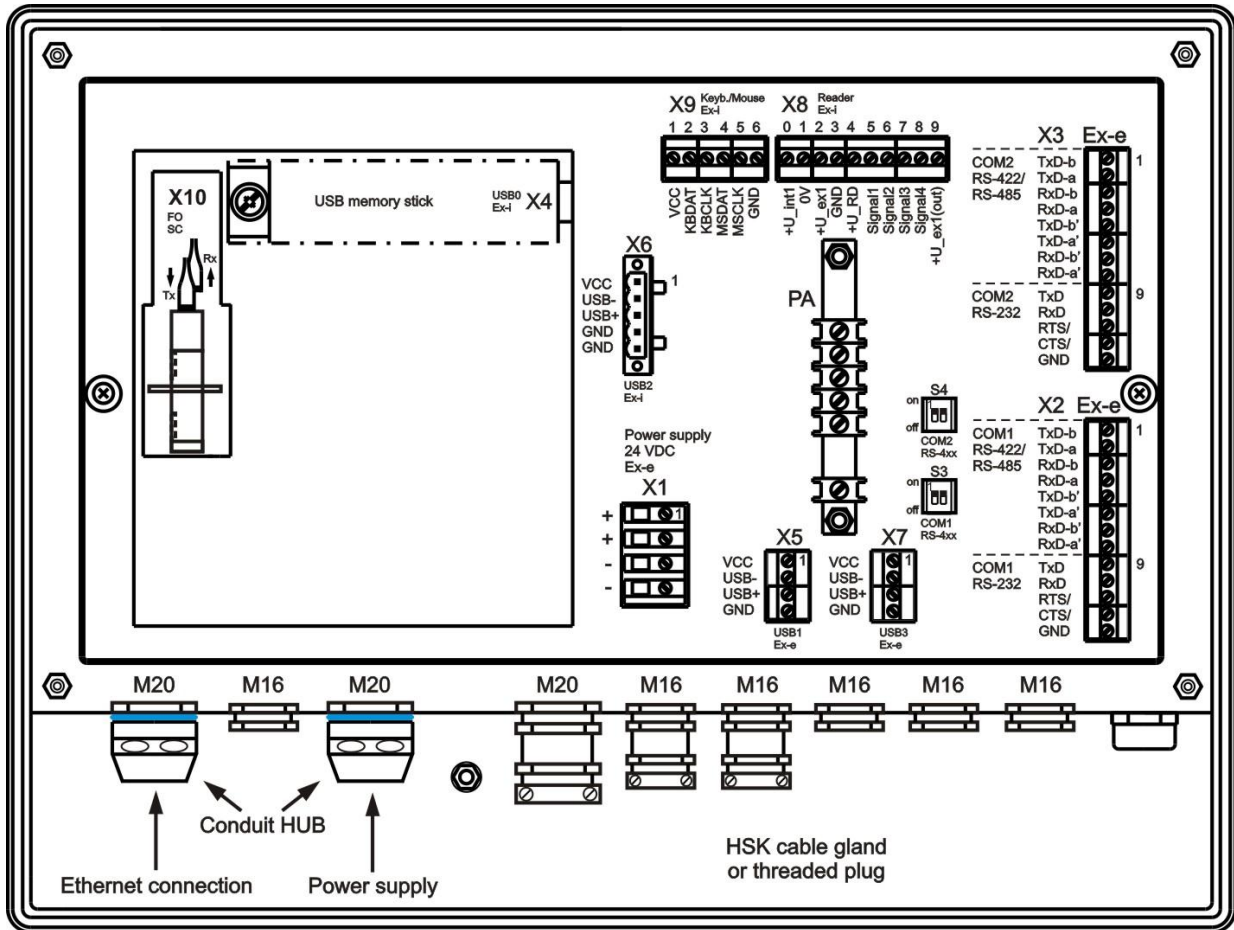

Any cable glands at the operator interface that are not required **MUST BE** replaced by threaded plugs so that the opening in the housing is covered.

☞ Please only use the cable glands for the cables indicated in the CONTROL DRAWINGS !

20.5 Control Drawings

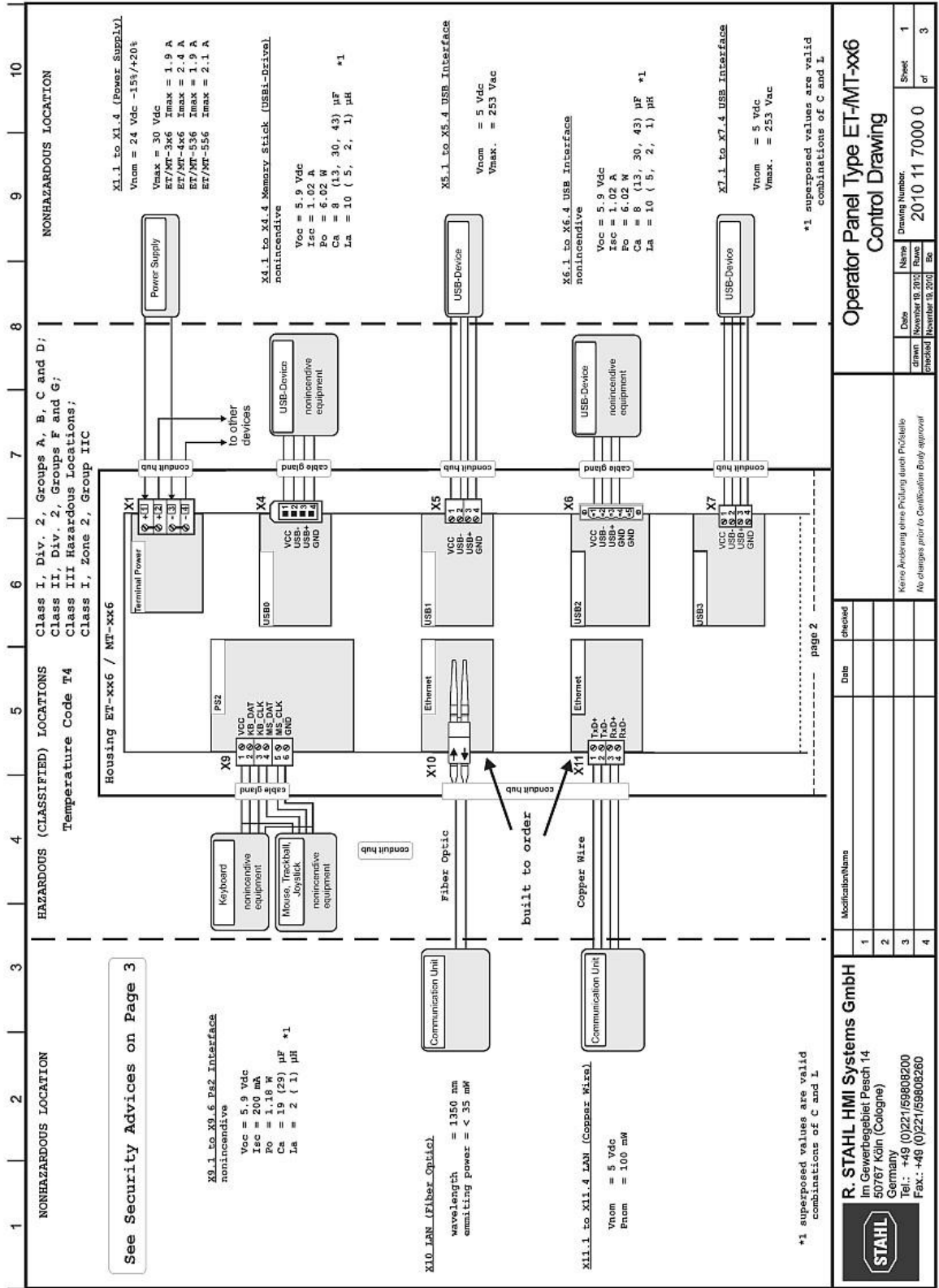

<p>Operator Panel Type ET/MT-xx6 Control Drawing</p>		<p>2010 11 7000 0</p>	<p>Sheet 1 of 3</p>
<p>Modification/Name</p>	<p>Date</p>	<p>checked</p>	<p>Drawn</p>
<p>1</p>	<p></p>	<p>November 18, 2010</p>	<p>2010 11 7000 0</p>
<p>2</p>	<p></p>	<p>checked</p>	<p></p>
<p>3</p>	<p>Keine Änderung ohne Prüfung durch Prüfstelle</p>	<p>November 18, 2010</p>	<p></p>
<p>4</p>	<p>No changes prior to Certification Body approval</p>	<p></p>	<p></p>

STAHL

R. STAHL HMI Systems GmbH
 Im Gewerbegebiet Pesch 14
 50767 Köln (Cologne)
 Germany
 Tel.: +49 (0)221/59808200
 Fax: +49 (0)221/59808260

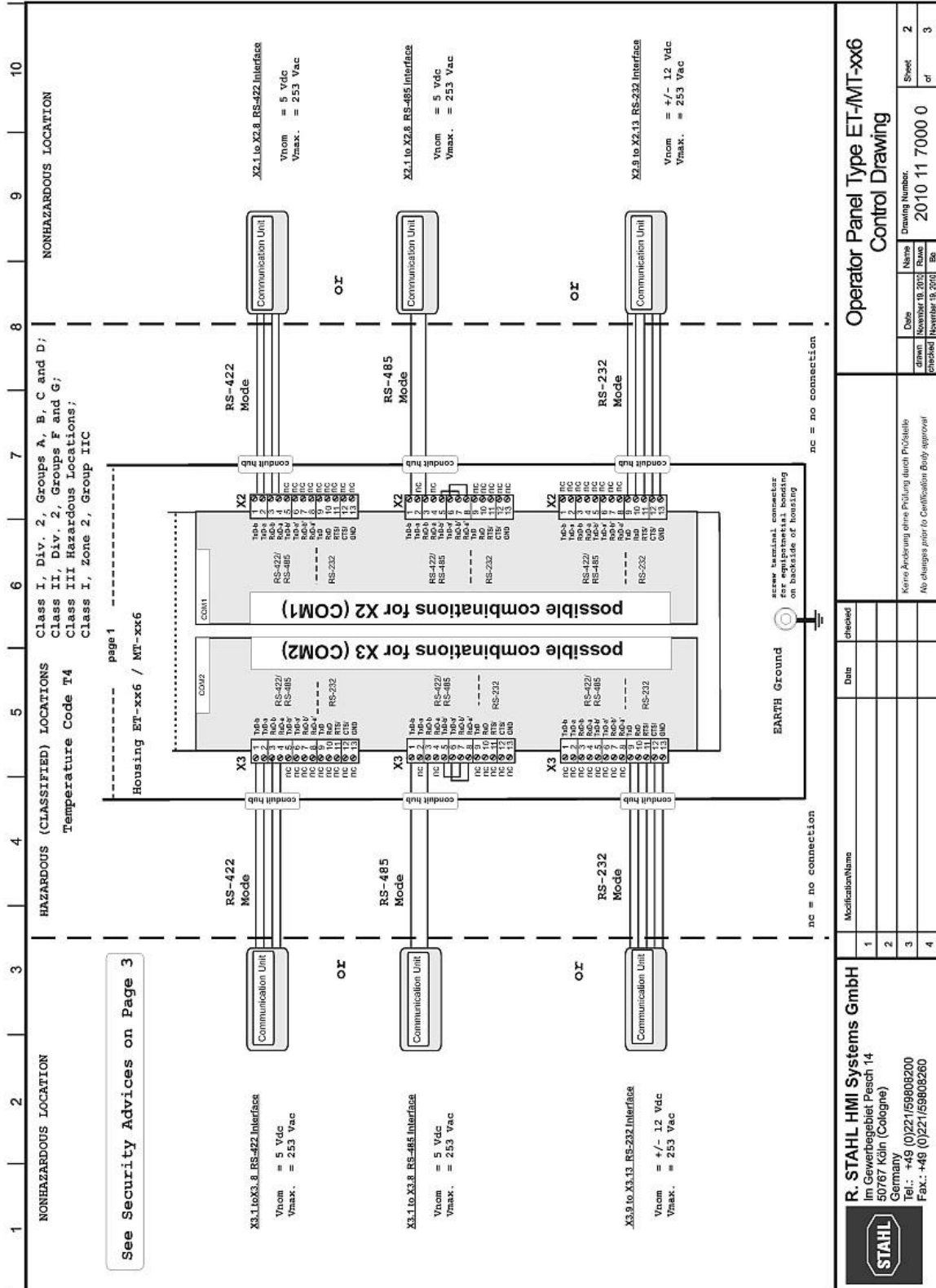

21 Accessories

21.1 Phoenix Contact terminal block

21.1.1 Data sheet Mini-Ex-terminal

Please note that when connected to the operator interfaces the connection values for the explosion proof terminals are limited (see also [Chapter "Ex-e terminals"](#))!



Mini-Terminal Block MBK

Article description	MBK 3/E-Z *
Article no.	1413036 *
EC-TYPE EXAMINATION CERTIFICATE IECEX-CERTIFICATE	KEMA 01ATEX2134 U * IECEX KEM 07.0008 U
Marking	Ex e II KEMA 01ATEX2134 U IECEX KEM 07.0008 U
Assembly on mounting rails	NS 15 acc. to EN 60715-TH 15
Stripping length	8 mm
Torque	0,6 - 0,8 Nm
Assembly instructions	See page 2
Operating temperature range	-50 °C ... +110 °C



Technical data according to EN 60079-7 (increased safety „e“)

Rated insulation voltage	250 V
Rated voltage	275 V
Nominal current	22,5 A
Max. rated current	28 A

Connection capacity

Rated cross-section	2,5 mm ²	AWG 14
Max. conductor cross-section	4 mm ²	AWG 12
Connectable conductor cross-section	0,2 - 4 mm ² rigid	AWG 24 - 12
	0,2 - 2,5 mm ² flexible	AWG 24 - 14

Multi-conductor connection (2 conductors of the same cross-section)

rigid / flexible	0,2 - 4 mm ² rigid	AWG 24 - 12
	0,2 - 2,5 mm ² flexible	AWG 24 - 14

Data of insulation material

Description	PA 6.6
Creep resistance acc. to IEC 60112 / material group	CTI 600 / I

Accessories

	Description	Article no.	
Cover	D-MBK/E	1415021	
Fixed bridge bar	FBR1 10-5 N	2770642	22,0 A / 2,5 mm ²
			22,5 A / 4 mm ²

* valid for colour variants

Important assembly instructions – increased safety „e“

The Terminal Blocks are suitable for use in enclosures in atmospheres with flammable gases or combustible dust. For flammable gases these enclosures must satisfy the requirements according to EN 60079-0 and EN 60079-7. For combustible dust these enclosures must satisfy the requirements according to EN 50281-1-1.

When assembling with other certified series and sizes of terminal blocks and using belonging accessories, the required creepage distances and clearances have to be observed.

When using the fixed bridge bars to achieve a skipped bridging the rated voltage is reduced to 176 V.

If conductors with smaller cross section as the rated cross section are used, the belonging lower current has to be laid down in the EC-Type Examination Certificate of the complete apparatus.

The Terminal Blocks may be used, based on the self-heating when used at the nominal current and at ambient temperatures of -50 °C to +40 °C at the mounting position in electrical apparatus, e.g. junction and connection boxes, for temperature class T6. When the Terminal Blocks are used in electrical apparatus of temperature classes T1 up to T5, the highest temperature of the insulating material shall not exceed the maximum value of the operating temperature range.

The Terminal Blocks and their appropriate accessories have to be assembled as specified below.

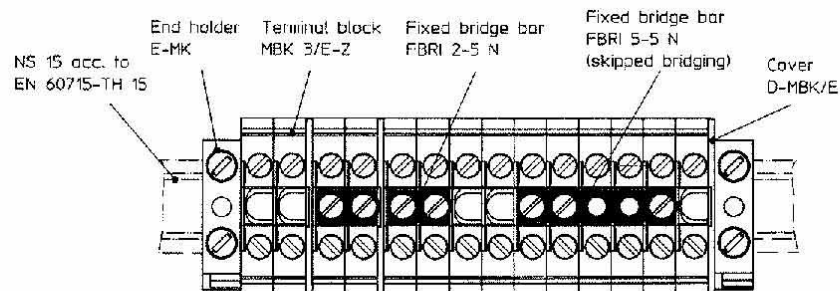

Operational instructions – Intrinsic safety “i”

EN 60079-14 Clause 12 describes modular terminal blocks as simple apparatus when used in intrinsically-safe circuits. Testing by a notified body and marking is not required. If terminal blocks be identifiable as part of an intrinsically circuit are marked by a colour, the colour used shall be light blue.

Testing for compliance to intrinsically safe requirements including clearance, creepage, and solid insulation distances specified in EN 60079-0 (EN 50014) and EN 60079-11 (EN 50020) have been performed for circuits up to **60 V**.

Compliance with distance requirements of EN 60079-14 Clause 12.2.3 for the connection of separated intrinsically-safe circuit accessories is met. A minimum distance of 50 mm to separate clamping units of intrinsically-safe and non intrinsically-safe circuits is required through the use of a separating plate or similar device.

Attestation of Conformity

The above mentioned product is in line with the provisions of the below marked directive and their modification directive(s):

94/9/EC ATEX Directive

Compliance with Essential Health and Safety Requirements has been assured by compliance with:

EN 60079-0:2004 EN 60079-7:2003 EN 50281-1-1:1998 + A1

The conformity with the provisions of the ATEX directive were certified by

Notified Body: KEMA Quality B.V.
 Address: Utrechtseweg 310, NL-6812 AR Arnhem, The Netherlands [Ident.-No.: 0344]
 Certificate: KEMA 01ATEX2134 U, 2006-05-15
 (No., Date)



Blomberg, 2007-12-05

I. A. Gerhard Leißmann
 Business Unit Device Connection
 Technology
 Ex-Representative

Dirk Görlitzer
 Business Unit Industrial Connection
 Technology
 Head of Business Unit

This attestation certifies the conformity with the indicated directive, it does not, however, covenant any characteristics. The instructions for safety and installation have to be observed.

Phoenix Contact GmbH & Co. KG
 Flachmarktstraße 8
 32825 Blomberg
 Germany

 +49 – (0) 52 35 – 3-00
 +49 – (0) 52 35 – 3-4 12 00
 www.phoenixcontact.com

22 Declaration of EC conformity

EG - Konformitätserklärung EC-Declaration of Conformity CE-Déclaration de Conformité



Wir / We / Nous

R. STAHL HMI Systems GmbH
Im Gewerbegebiet Pesch 14
D-50767 Köln

erklären in alleiniger Verantwortung dass unser(e) Produkt(e):

declare under our sole responsibility that the product(s):

attestons sous notre responsabilité que le(s) produit(s):

Exicom

ET-306, ET-316, ET-336 (-VA)

ET-406, ET-416, ET-436 (-VA), ET-456 (-VA)

ET-506, ET-516, ET-536 (-VA), ET-556 (-VA)

gekennzeichnet:

marked:

marqué:



II 2 (2) G Ex d e mb ib [ib] [op is] IIC T4

II 2 D Ex tD A21 IP65 T90°C

übereinstimmend ist (sind) mit der (den) folgenden Norm(en) oder normativen Dokumenten:

is (are) in conformity with the following standard(s) or normative documents:

est (sont) conforme aux norme(s) ou aux documents normatifs suivants:

Bestimmung der Richtlinie <i>Terms of the directive</i> Prescription de la directive	Titel und/oder Nr. sowie Ausgabedatum der Norm <i>Title and/or No. and date of issue of the standard</i> Titre et/ou No. ainsi que date d'émission des normes	
2004/108/EG: Elektromagnetische Verträglichkeit <i>2004/108/EC: Electromagnetic compatibility</i> 2004/108/CE: Compatibilité électromagnétique	EN 61000-6-2:2005 EN 61000-6-4:2007	
94/9/EG: Geräte und Schutzsysteme zur bestimmungsgemäßen Verwendung in explosionsgefährdeten Bereichen <i>94/9/EC: Equipment and protective systems intended for use in potentially explosive atmospheres</i> 94/9/CE: Appareils et systèmes de protection destinés à être utilisés en atmosphères explosibles	EN 60079-0:2006 EN 60079-1:2007 EN 60079-7:2007 EN 60079-11:2007 EN 60079-18:2004 EN 60079-28:2007	EN 61241-0:2006 EN 61241-1:2004
EG-Baumusterprüfbescheinigung Nr., ausgestellt durch benannte Stelle: <i>EC-Type Examination Certificate No., issued by notified body:</i> Attestation d'examen CE de type No. exposé par organisme notifié:	TÜV 05 ATEX 7176 X TÜV Rheinland Industrie Service GmbH TÜV Rheinland Group Am Grauen Stein 51105 Köln/Cologne Deutschland/Germany/Allemagne	

Köln, den 01.04.2010

Ort und Datum
Place and date
lieu et date

Joachim Düren
Technical Director

Werner Bertges
Quality Manager

23 Release Notes

The chapter entitled "Release Notes" contains all the changes made in every version of the operating instructions.

Version 02.05.11

- Correction of "equipotential" in section 13.2 "General information"
- Addition section 7 "Product identification"
- Deletion of previous information on the document versions
- Removal of all certificates to make up a separate document
- Inclusion of -40 °C in the chapter entitled Technical Data
- Inclusion of Chinese CNEX certificate in chapter 6 "Certificates"
- Inclusion of Kazakh CKT certificate in chapter 6 "Certificates"
- Inclusion of UL certificate in chapter 6 "Certificates"
- Deletion of certificate information from chapter entitled Technical Data
- Addition of installation notes regarding NEC in chapter 13.2 "Installation"
- Inclusion of section 20 "UL certificate"
- Inclusion of note concerning separate documentation with certificates in section "Preface"
- Inclusion of comment "+55°C with ATOM processors in chapter "Technical Data"
- Removal of "Protect operator interfaces against permanent UV-exposure" in chapter "Safety Advice", section "Installation and Operation"
- Inclusion of section "Operation in countries covered by NEC" in the chapter "Safety Advice", section "Installation and Operation"
- Re-named chapter "Software Installation", new name: "Installation via USB interfaces"
- Insert "Protect operator interfaces against permanent UV-exposure" into chapter "Installation - "ET-4x6-Tx, ET-4x6-Fx"
- Adapted "Autotype" link
- Removal of ElexV and VDE0100 in chapter "Installation"
- Inclusion of comment "not for NEC" for terminal block

Version 02.05.12

- Addition type code for UL device
- Addition product identification for UL device
- Changing of section "UL certification"
- Changing of "operation UL device in NEC" in section "Installation and operation"
- Removal of "operation UL device in NEC" in section "Installation"

R. STAHL HMI Systems GmbH
Im Gewerbegebiet Pesch 14
D-50767 Köln

Phone: (switchboard) +49/(0)221/ 5 98 08 - 200
(hotline) - 59

Fax: - 260

E-mail: (switchboard) office@stahl-hmi.de
(hotline) support@stahl-hmi.de

www.stahl.de
www.stahl-hmi.de

