



THE STRONGEST LINK.

Operating Instructions

Joystick JSi-3-*

R. STAHL HMI Systems GmbH
Adolf-Grimme-Allee 8
50829 Köln

Version 01.03.05
Issue date: 10.10.2019

Disclaimer

Publisher and copyright holder:

R. STAHL HMI Systems GmbH
Adolf-Grimme-Allee 8
D 50829 Köln

Phone: (switchboard) +49 (0) 221 76 806 - 1000
(hotline) - 5000
Fax: - 4100
E-mail: (switchboard) office@stahl-hmi.de
(hotline) support@stahl-hmi.de

- All rights reserved.
- This document may not be reproduced in whole or in part except with the written consent of the publisher.
- This document may be subject to change without notice.

Any warranty claims are limited to the right to demand amendments. Liability for any damage that might result from the content of this description or all other documentation is limited to clear cases of premeditation.

We reserve the right to change our products and their specifications at any time, provided it is in the interest of technical progress. The information in the current manual (in the internet and on CD / DVD / USB stick) or in the operating instructions included with the device applies.

Trademarks

The terms and names used in this document are registered trademarks and / or products of the companies in question.

Copyright © 2019 R. STAHL HMI Systems GmbH. Subject to alterations.

Specific markings

The markings in these operating instructions refer to specific features that must be noted.

In detail, these are:

 DANGER	This sign alerts users to hazards that will result in death or serious injury if ignored !
---	---

 WARNING	This sign alerts users to hazards that may result in death or serious injury if ignored !
--	--

 CAUTION	This sign alerts users to hazards that may damage machinery or equipment or result in injury if ignored !
--	---

 ATTENTION	Information highlighted by this symbol indicates measures for the prevention of damage to machinery or equipment !
--	--

 NOTICE	Information highlighted by this symbol indicates important information of which particular note should be taken !
---	---

 DOCUMENTATION	Information highlighted by this symbol refers to a different chapter or section in this manual or other documentation or a web-page !
--	---

Warnings



 Caution !	In ambient temperatures exceeding +45 °C the surface of the devices may heat up. Caution when touching !
--	--

Table of contents

	Description	Page
	Disclaimer	2
	Specific markings	3
	Warnings	3
	Table of contents	4
1	Preface	5
2	Function	5
3	Conformity to standards	5
4	Certificates	6
4.1	ATEX	6
4.2	IECEX	6
5	Marking	6
6	Safety-related data	6
7	Ambient temperature range	7
8	Proof of intrinsic safety	7
8.1	General information	7
8.2	Interconnection	8
8.2.1	JSi-3-PS2	8
8.2.2	JSi-3-USB	9
9	Type code	10
10	Safety Advice	10
10.1	Installation and operation	11
11	Assembly and disassembly	11
11.1	General information	11
11.2	Views	12
11.3	Mechanical dimensions	13
11.3.1	Overview	13
11.3.2	Dimensional drawing	13
11.4	Installation instructions	15
12	Operation	15
12.1	General information	15
12.2	Connections JSi	16
12.2.1	Connection cable JSi-3-PS2-*	16
12.2.2	Connection cable JSi-3-USB-*	17
13	Maintenance, service	17
13.1	Servicing	18
14	Troubleshooting	18
15	Disposal	18
15.1	RoHS directive 2011/65/EC	18
15.1.1	China RoHS labelling	18
16	Declaration of EC conformity	19
17	Release notes	20

1 Preface

These operating instructions are intended for the safe installation of the JSi-3-* joysticks and cover all Ex-relevant aspects. Furthermore, these operating instructions contain all necessary information for assembly and connection of the joysticks.

 NOTICE	All data relevant to explosion protection from the EC-type examination certificate were copied into these operating instructions.
	For the correct operation of all associated components please note, in addition to these operating instructions, all other operating instructions enclosed in this delivery as well as the operating instructions of the additional equipment to be connected !

 DOCUMENTATION	Please note that all certificates of the joysticks can be found in a separate document (CE_Joystick-JSi). You can find this document in the internet at www.r-stahl.com or request it from R. STAHL HMI Systems GmbH.
	For more information on the HMIs please also refer to the Manual (available as online manual on www.r-stahl.com).

2 Function

The type JSi-3-* joysticks are used to enter data, commands etc. on PCs and similar devices in hazardous areas.

The type JSi-3-* joysticks are explosion-protected equipment for installation in hazardous areas of zones 1 and 2. The devices may be connected to intrinsically safe PS2 or USB interfaces, depending on the joystick version. Power supply and data communication takes place via the associated interface of the operator interfaces. The joystick is connected with a fixed cable. The joysticks can be mounted inside a front panel or a desktop housing.

3 Conformity to standards

The joysticks comply with the following standards and directive:

Standard	Classification
3rd supplement	
ATEX directive 2014/34/EU	
IEC 60079-0 : 2011 EN 60079-0 : 2012 + A11	General requirements
IEC 60079-11 : 2011 EN 60079-11 : 2012	Intrinsic safety "i"
Electromagnetic compatibility	
EMC directive 2014/30/EU	Classification
EN 61326-1 : 2006	General requirements

4 Certificates

The joysticks JSi-3-* are certified for installation in the following areas:

Europe:

according to ATEX directive
for installation in zones 1 and 2

International / Australia:

IECEX (International Electrotechnical Commission System for Certification to Standards for Electrical Equipment for Explosive Atmospheres)

4.1 ATEX

The ATEX certification is listed below the following number:

Certificate number: BVS 08 ATEX E 081

4.2 IECEX

The IECEX certification is listed below the following number:

Certificate number: IECEX BVS 08.0032

 DOCUMENTATION	You can access all IECEX certificates on the official website of the IEC under their certificate number. http://iecex.iec.ch/iecex/iecexweb.nsf/welcome?openform .
---	---

5 Marking

Manufacturer	R. STAHL HMI Systems GmbH	
Type code	JSi-3-PS2-*, JSi-3-USB-*	
CE classification:	CE ₀₁₅₈	
Testing authority and certificate number:	BVS 08 ATEX E 081 IECEX BVS 08.0032	
Ex classification:		
ATEX directive		II 2 G Ex ib IIC T4
IECEX		Ex ib IIC T4

6 Safety-related data

	JSi-3-PS2	JSi-3-USB
U _i	5.9 VDC	5.9 VDC
I _i	350 mA	3 A
P _i	1.2 W	6.02 W
C _i	7 µF	7 µF
L _i	1 µH (1 m connection cable)	
	1.5 µH (1.5 m connection cable)	
	2 µH (2 m connection cable)	
	3 µH (3 m connection cable)	
	4 µH (4 m connection cable)	
	5 µH (5 m connection cable)	

7 Ambient temperature range

The temperature range is -20 °C up to $+60\text{ °C}$

8 Proof of intrinsic safety

Proof of intrinsic safety for the connection of JSi-3-* joysticks with ET-/MT-xx6-A HMI devices.

8.1 General information

Proof of intrinsic safety is based on the principles of IEC/EN 60079-14 and the standards referred to therein. Particular reference is made to Chapter 12 "Additional requirements for the type of protection i - intrinsic safety" in IEC/EN 60079-14.

Proof has been drawn up on the basis of conformity certification as per IEC/EN 60079-0 and IEC/EN 60079-11 or the EC type examination certificate in accordance with Directive 2014/34/EU and the comparison of the safety-related data listed in these documents.

The following EC-type examination certificates were used:

<i>Device</i>		<i>EC type examination certificate</i>
ET-xx6-A	—	TÜV 11 ATEX 7041 X
MT-xx6-A	—	TÜV 11 ATEX 7103 X
JSi-3-PS2-*, JSi-3-USB-*	—	BVS 08 ATEX E 081

The testing authority has listed **all** conditions applicable to intrinsic safety in the EC type examination certificates.

If an EC type examination certificate for a device only specifies the input voltage (U_i), for example, intrinsic safety is guaranteed if the associated supply does not exceed this voltage (U_o is less than / equals U_i).

Other output parameters specified in the examination certificate of the power supply (e.g. I_o , P_o) are in this case irrelevant to intrinsic safety.



NOTICE

The data given in this document do **NOT** absolve the fitter and / or operator of the systems from their obligation to ensure compliance with legal requirements, directives and regulations. Due diligence remains the sole responsibility of the fitter and / or operator !

8.2 Interconnection

In this part we list the voltages, currents, capacitance and inductance values of all circuits to determine whether the JSi-3-* joysticks are connected with a standard cable of 1.7 metres (usable are 1.5 metres) to the HMI devices of 400 Open HMI - Panel PC and 500 Remote HMI Thin Client SERIES.

 NOTICE	The data given for this interconnection do NOT absolve the fitter and / or operator of the systems from their obligation and responsibility to ensure compliance with legal requirements, directives and regulations. Due diligence remains the sole responsibility of the fitter and / or operator !
---	--

If the engineer or operator extends the joystick cable, the additional C and L cable values must be taken into account for the connection for proving intrinsic safety !

 NOTICE	From the Ex technical point of view, a maximum cable length of 5 metres is permitted ! Please note that we cannot comment on the functionality of such a cable extension.
---	--

8.2.1 JSi-3-PS2

- a) ET-/MT-xx6-A HMI device with joystick JSi-3-PS2 (1.7 m connection cable) circuits in zone 1

Source / active					==>	Acceptor / passive
ET-/MT-xx6-A						JSi-3-PS2
Terminal X9						Joystick connection
U _o = 5.88 VDC					≤	U _i = 5.9 VDC
I _o = 200 mA					≤	I _i = 350 mA
P _o = 1.18 W					≤	P _i = 1.2 W
C _{OIC} [µF] =	15.4	-	-	-	≥	C _i = 7 µF
L _{OIC} [µH] =	2	-	-	-	≥	L _i = 1.7 µH
C _{OIB} [µF] =	10.4	20.4	43.4	82.4	≥	C _i = 7 µF
L _{OIB} [µH] =	100	50	20	10	≥	L _i = 1.7 µH

C_o and L_o pairs directly above/underneath each other may be used.

- b) MT-xx6-A HMI device with joystick JSi-3-PS2 (1.7 m connection cable) circuits in zone 2

Source / active					==>	Acceptor / passive
MT-xx6-A						JSi-3-PS2
Terminal X9						Joystick connection
U _o = 5.88 VDC					≤	U _i = 5.9 VDC
I _o = 200 mA					≤	I _i = 350 mA
P _o = 1.18 W					≤	P _i = 1.2 W
C _{OIC} [µF] =	68.4	-	-	-	≥	C _i = 7 µF
L _{OIC} [µH] =	2	-	-	-	≥	L _i = 1.7 µH
C _{OIB} [µF] =	33.4	53.4	102.4	222.4	≥	C _i = 7 µF
L _{OIB} [µH] =	100	50	20	10	≥	L _i = 1.7 µH

C_o and L_o pairs directly above/underneath each other may be used.

8.2.2 JSi-3-USB

- a) ET-/MT-xx6-A HMI device with joystick JSi-3-USB (1.7 m connection cable)
circuits in zone 1

Source / active					==>	Acceptor / passive
ET-/MT-xx6-A						JSi-3-USB
Terminal X6						Joystick connection
U _o = 5.9 VDC					≤	U _i = 5.9 VDC
I _o = 2.18 A					≤	I _i = 3 A
P _o = 1.24 W					≤	P _i = 6.02 W
C _{OIC} [μF] =	11	28	-	-	≥	C _i = 7 μF
L _{OIC} [μH] =	5	2	-	-	≥	L _i = 1.7 μH
C _{OIB} [μF] =	14	40	79	200	≥	C _i = 7 μF
L _{OIB} [μH] =	50	20	10	5	≥	L _i = 1.7 μH

C_o and L_o pairs directly above/underneath each other may be used.

- b) MT-xx6-A HMI device with joystick JSi-3-USB (1.7 m connection cable)
circuits in zone 2

Source / active					==>	Acceptor / passive
MT-xx6-A						JSi-3-USB
Terminal X6						Joystick connection
U _o = 5.9 VDC					≤	U _i = 5.9 VDC
I _o = 2.18 A					≤	I _i = 3 A
P _o = 1.24 W					≤	P _i = 6.02 W
C _{OIC} [μF] =	12	24	74	-	≥	C _i = 7 μF
L _{OIC} [μH] =	10	5	2	-	≥	L _i = 1.7 μH
C _{OIB} [μF] =	37	92	200	790	≥	C _i = 7 μF
L _{OIB} [μH] =	50	20	20	5	≥	L _i = 1.7 μH

C_o and L_o pairs directly above/underneath each other may be used.

9 Type code

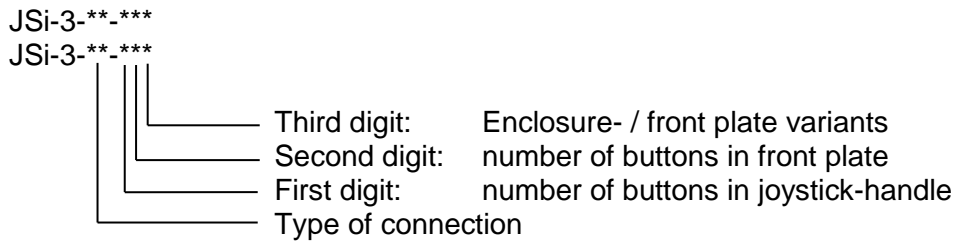

Variants:

Variant code						Description
						Joystick variante with
JSi-3-	PS2	-	*	*	*	PS2 connection
	USB	-	*	*	*	USB connection
		-	0			No button in joystick-handle
		-	1			One button in joystick-handle
		-	2			Two button in joystick-handle
		-		0		No button in front plate
		-		1		One button in front plate
		-		2		Two button in front plate
		-		3		Three button in front plate
		-			0	Rectangular
		-			1	Triangular
		-			2	Round

Product type:

Order number	Description
Joystick version with	
JSi-3-PS2-130	PS2 connection, one button in joystick-handle, three button in front plate, stainless steel front plate rectangular
JSi-3-USB-130	USB connection, one button in joystick-handle, three button in front plate, stainless steel front plate rectangular

10 Safety Advice

	<p>This chapter is a summary of the key safety measures. The summary is supplementary to existing rules which staff also have to study.</p>
	<p>The safety of persons and equipment in hazardous areas depends on compliance with all relevant safety regulations. Thus, the installation and maintenance staff carry a particular responsibility, requiring precise knowledge of the applicable regulations and conditions.</p>

	<p>The notes listed below in section 10.1 must be heeded to avoid injury and damage to equipment !</p>
--	--

10.1 Installation and operation

Please note the following when installing and operating the device:

- The national regulations for installation and assembly apply (e.g. IEC/EN 60079-14).
- The joysticks may be installed in zones 1 or 2.
- The JSi-3-* joystick enclosure must be earthed via the PA connection (earthing screw) at the back of the enclosure !
- The intrinsically safe circuits must be installed according to applicable regulations.
- The joystick may only be switched on when it is closed.
- When installed in zones 1 and 2, the joysticks may be connected to intrinsically safe input circuits.
- The safety values of the joysticks must match those of the device to which it is connected.
- Interconnecting several active devices in an intrinsically safe circuit may result in different safe maximum values. This could compromise intrinsic safety !
- National safety and accident prevention rules.
- Generally accepted technical rules.
- Safety instructions contained in these operating instructions.
- Any damage may compromise the explosion protection.

Use the joysticks for their intended purpose only (see "Function").

Incorrect or unauthorized use and non-compliance with the instructions in this manual will void any warranty on our part.

No changes may be made to the joysticks that compromise explosion protection !

The joysticks may only be installed and operated in an undamaged, dry and clean condition !

11 Assembly and disassembly

11.1 General information



Assembly and disassembly are subject to general technical rules. Additional, specific safety regulations apply to electronic and pneumatic installations.

11.2 Views

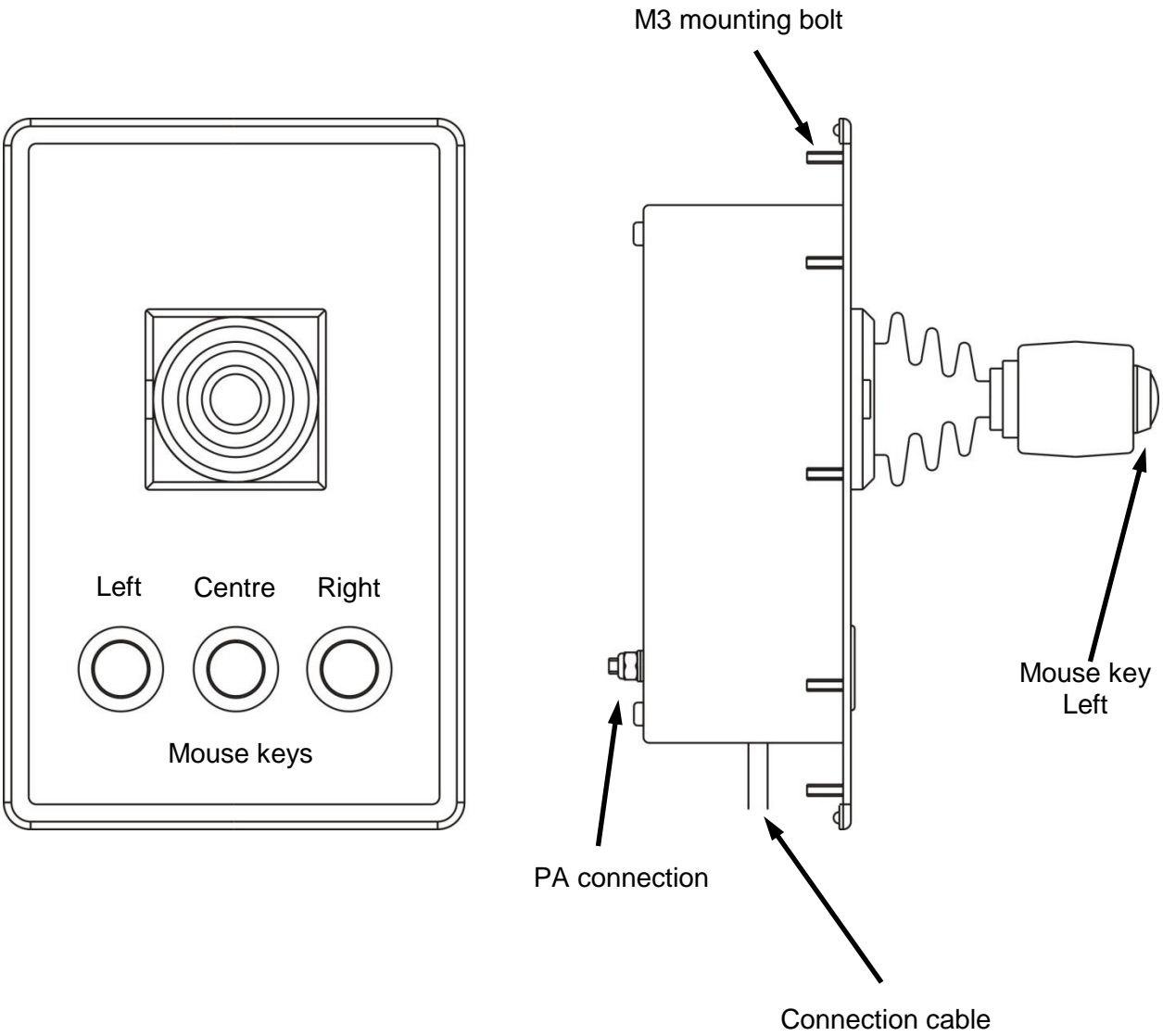

NB:

- The key on the joystick has the same function as a left mouse key. There are therefore two keys on the JSi joystick that have the "left mouse key" function.

11.3 Mechanical dimensions

Dimensions in mm

11.3.1 Overview

Joystick	Front plate (HxB)	Cut-out (HxB)	Hole pattern	Material thickness
JSi-3-PS2 JSi-3-USB	185 x 120	152 x 90 (±1)	see diagram	up to 6
	Depth of cut-out (Depth)		Design front (Height)	
	60		83 (joystick height)	

11.3.2 Dimensional drawing

Front view:

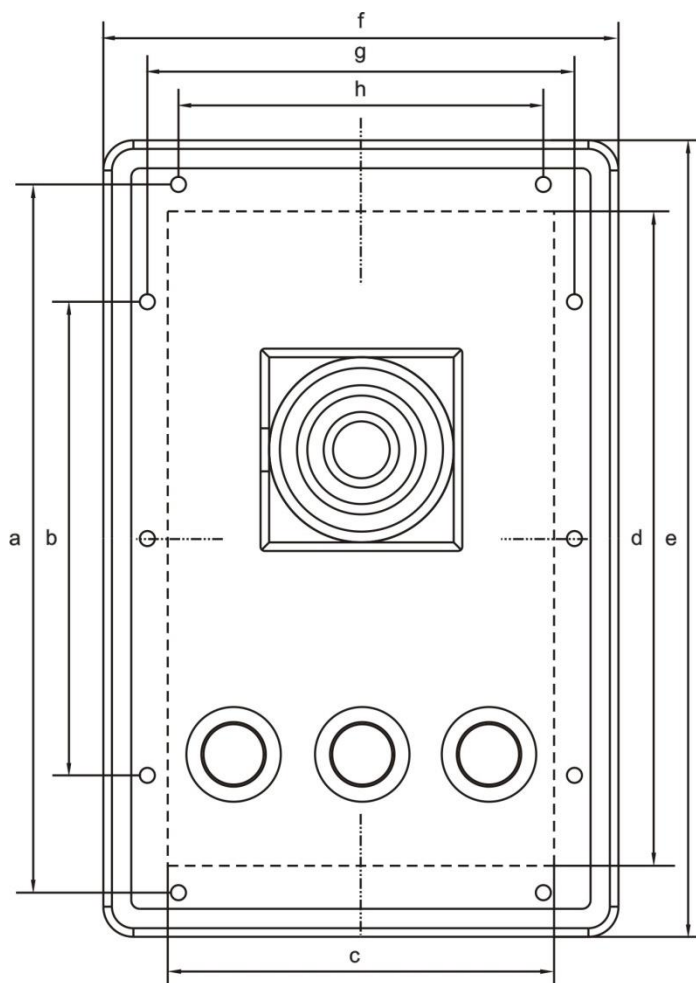

- e = dimensions front plate height (h) = 185
- f = dimensions front plate width (w) = 120
- c = cut-out width (w) = 90 (± 1)
- d = cut-out height (h) = 152 (± 1)
- a = distance fitting holes = 164.5
- b = distance fitting holes = 110
- g = distance fitting holes = 99.5
- h = distance fitting holes = 85

Lateral view:

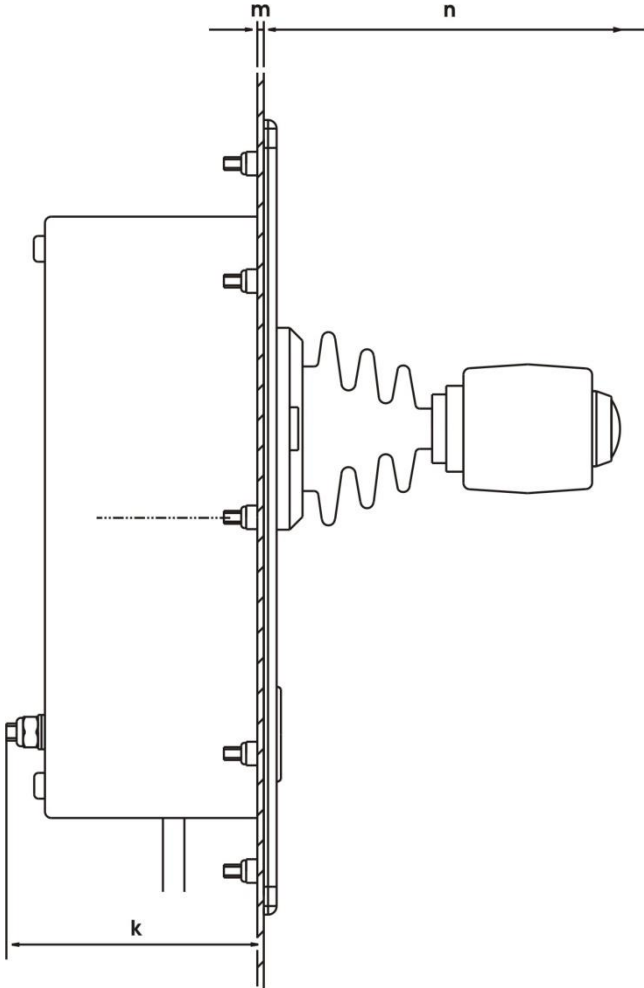

- k = depth of cut-out = 60
- m = material thickness = up to 6
- n = design front height = 83

11.4 Installation instructions

The JSi-3-* joystick is intended for installation in an appropriate desk housing or control panel.

If the JSi-3-* joystick has **NOT** been mounted by the manufacturer, a sufficiently large cut-out for mounting the joystick must be provided.

- Make a cut-out with the dimensions mentioned above.
- Drill 10 holes of a diameter of 3.5 mm according to the hole pattern.
- Insert the joystick into the cut-out from the outside.
- For affixing the joystick use the self-locking nuts (10x M3) provided with the joystick.

 ATTENTION	<p>Optimum sealing:</p> <ul style="list-style-type: none"> • Check the position of the joystick, ensuring above all that the rubber seals are correctly positioned. • Then tighten fully all self-locking nuts with a tightening torque of 0.1 - 1.5 Nm. • Connect the joystick cable to the corresponding terminal at the HMI device according to the connection diagram.
	<p>Earth:</p> <ul style="list-style-type: none"> • The JSi-3-* joystick housing must be earthed via the PA connection (earthing screw) at the back of the housing ! • A wire cross section of 4 mm² is recommended for earthing the device.

12 Operation

12.1 General information

 NOTICE	<p>When operating the devices, particular care shall be taken that:</p> <ul style="list-style-type: none"> • the joystick has been properly installed according to instructions, • the joystick is not damaged, • all screws are tightened fast, • the cable is connected properly, • the joystick housing has been connected to earth via the PA connection.
---	--

12.2 Connections JSi

The joysticks are fitted with an 1.7 m long connection cable (usable length 1.5 m) that can be connected to the corresponding terminal of the 4x6 (Panel PC) or 5x6 (Thin Clients) series HMI devices.

In the case of joystick version JSi-3-* the connection depends on the interface version (PS2 or USB). The version with PS2 interface is connected to terminal X9 keyboard/mouse /trackball/joystick, and the USB interface version is connected to terminal X6 of the HMI devices.

12.2.1 Connection cable JSi-3-PS2-*

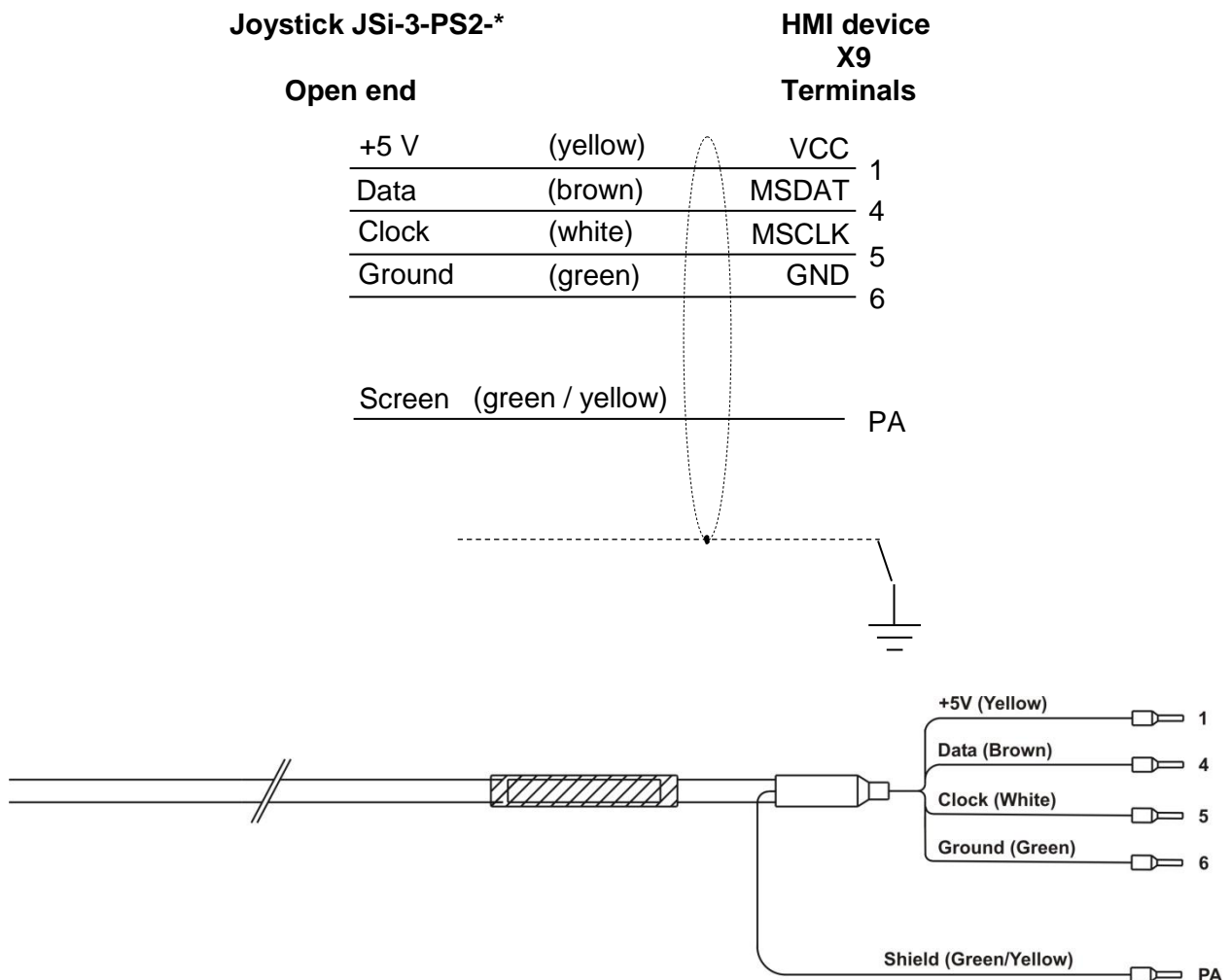

CAUTION The shielding connection (green / yellow cable) must be connected to the PA terminal block of the HMI devices !

12.2.2 Connection cable JSi-3-USB-*

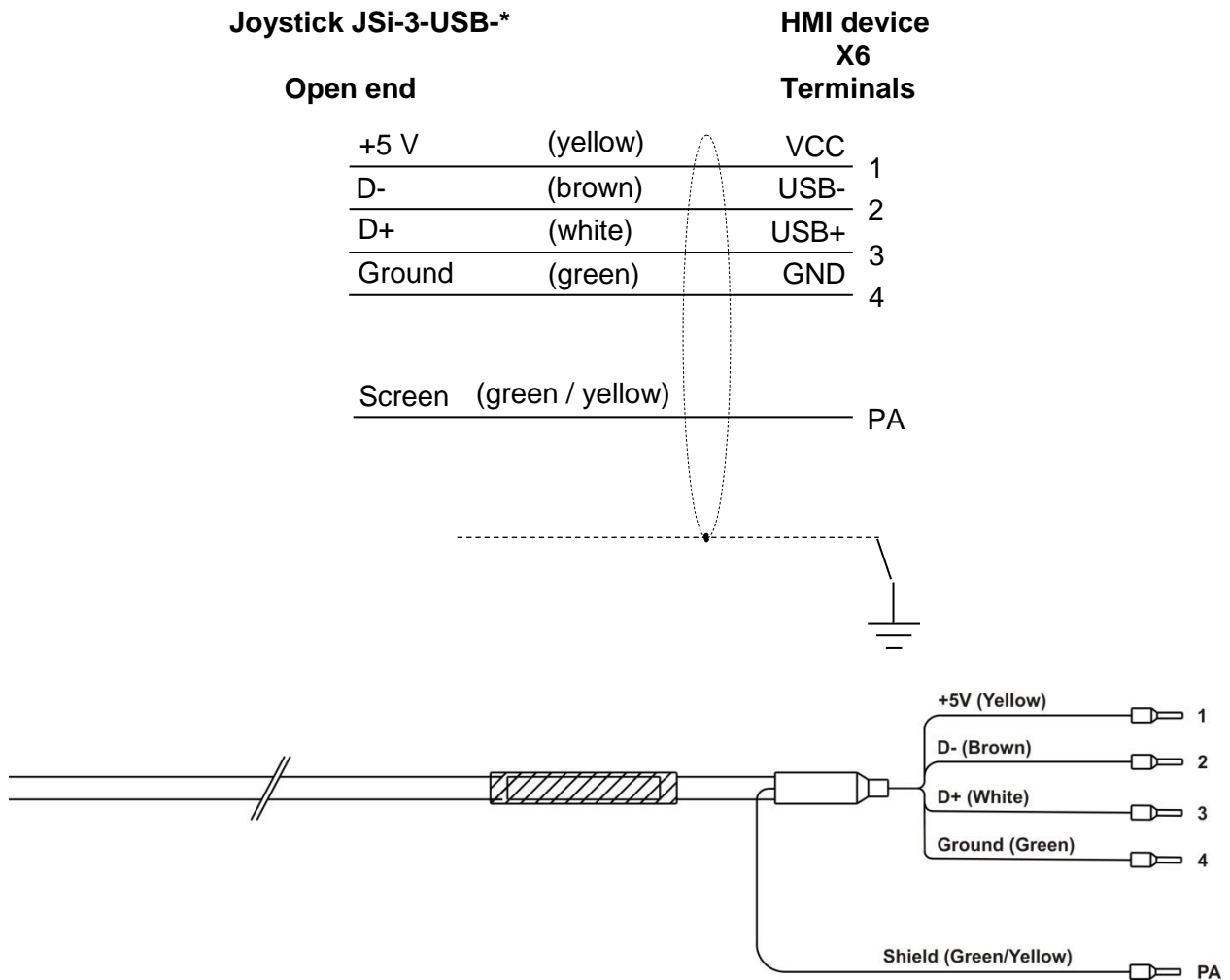

CAUTION The shielding connection (green / yellow cable) must be connected to the PA terminal block of the HMI devices !

13 Maintenance, service

NOTICE Associated equipment is subject to maintenance, service and testing according to guidelines 1999/92/EC, IEC/EN 60079-14, -17, -19 and BetrSichVer (Betriebssicherheitsverordnung - Occupational Safety and Health) !

Because the transmission of the joysticks remains reliable and stable over long periods of time, regular adjustments are not required.

Maintenance should focus on the following:

- Seal wear
- All cables and lines are properly connected and undamaged
- Enclosure damage

13.1 Servicing

It is the responsibility of the operator of an electrical plant in a hazardous environment to have the plant serviced. Please also note the appropriate national rules and regulations.

14 Troubleshooting

Users cannot carry out any repairs on the joysticks.

	Devices operated in hazardous areas must not be modified. Repairs may only be carried out by qualified, authorized staff specially trained for this purpose.
	Repairs may only be carried out by specially trained staff who are familiar with all basic conditions of the applicable user regulations and – if requested – have been authorized by the manufacturer.

15 Disposal

Disposal of old electric and electronic devices, packaging and used parts is subject to regulations valid in whichever country the device has been installed.

For countries under the jurisdiction of the EU the corresponding WEEE directive applies.

The joysticks are classified according to the table below:

	old	new
Directive	WEEE I Directive 2002/96/EC	WEEE II Directive 2012/19/EU
Valid	until 14.08.2018	from 15.08.2018
Category	9 Monitoring and control devices	SG5 Small equipment <50 cm

We shall take back our devices according to our General Terms and Conditions.

15.1 RoHS directive 2011/65/EC

The revised version of the RoHS (restriction of hazardous substances) 2002/95/EC directive, directive 2011/65/EC, extends its area of application to all electric and electronic products.

The joysticks are conform with the requirements from RoHS directive 2011/65/EU, dated 03.01.2013.

15.1.1 China RoHS labelling

According to new Chinese legislation in force since 01.03.2007, all devices containing hazardous substances must be labeled accordingly.

The part of all toxic or hazardous substance contained in the homogeneous materials of the devices is below the limit stipulated in SJ/T11363-2006.

16 Declaration of EC conformity

EG/EU-Konformitätserklärung
EC/EU Declaration of Conformity
Déclaration de Conformité CE/UE



R. STAHL HMI Systems GmbH • Adolf-Grimme-Allee 8 • 50829 Köln, Germany
 erklärt in alleiniger Verantwortung, *declares in its sole responsibility, déclare sous sa seule responsabilité,*

dass das Produkt: **Joystick Modul**
that the product:
que le produit:

Typ(en), *type(s), type(s):* **JSi-3-PS2-*****
 und / and / et
JSi-3-USB-***

***=any character without relevance for explosion protection

mit den Anforderungen der folgenden Richtlinien und Normen übereinstimmt.
is in conformity with the requirements of the following directives and standards.
est conforme aux exigences des directives et des normes suivantes.

Richtlinie(n) / Directive(s) / Directive(s)		Norm(en) / Standard(s) / Norme(s)
Bis/Until/Jusque'au 2016-04-19:	Ab/From/De 2016-04-20:	EN 60079-0: 2012 EN 60079-11:2012
94/9/EG 94/9/EC 94/9/CE	ATEX-Richtlinie ATEX Directive Directive ATEX	2014/34/EU 2014/34/EU 2014/34/UE

Kennzeichnung, *marking, marquage:* II 2G Ex ib IIC T4 Gb

CE 0158

EG/EU-Baumusterprüfbescheinigung: **BVS 08 ATEX E 081**
EC/EU Type Examination Certificate:
Attestation d'examen CE/UE de type:
DEKRA EXAM GmbH (NB 0158)
 Dinnendahlstraße 9, 44809 Bochum, Germany

Bis/Until/Jusque'au 2016-04-19:	Ab/From/De 2016-04-20:	EN 61326-1: 2006
2004/108/EG 2004/108/EC 2004/108/CE	EMV-Richtlinie EMC Directive Directive CEM	2014/30/EU 2014/30/EU 2014/30/UE

Produktnormen nach RoHS-Richtlinie (2011/65/EU): EN 50581:2012
Product standards according to RoHS Directive:
Normes des produit pour la Directive RoHS:

Köln, 2015-12-11

i.V.

Jochen Düren

i.V.

W. Bertges

Ort und Datum
Place and date
Lieu et date

J. Düren
 Technical Director

W. Bertges
 Quality Manager

17 Release notes

The chapter entitled "Release Notes" contains all the changes made in every version of the Operating Instructions.

Version 01.03.05

- Removal of previous release notes
- Changing disclaimer
- Adaption type code according to examination certificate
- Changing cabel length into 1.7 m (usable 1.5 m)
- Adaption "Proof of intrinsic safety" according to new cabel length
- Addition of note in "Proof of intrinsic safety" with "max. cabel length of 5 m"
- Removal of note "joysticks with polyester" in "Installation and operation"
- Formal changes

R. STAHL HMI Systems GmbH
Adolf-Grimme-Allee 8
D 50829 Köln

T:	(switchboard)	+49 221 76 806	- 1000
	(Hotline)	+49 221 76 806	- 5000
F:		+49 221 76 806	- 4100
E:	(switchboard)	office@stahl-hmi.de	
	(hotline)	support@stahl-hmi.de	

r-stahl.com
stahl-hmi.de



THE STRONGEST LINK.