



Operating Instructions



KVM transmission units

Version KVM-*-CAT-*

Version KVM-*-MM-*

Version KVM-*-SM-*



THE STRONGEST LINK.

Operating Instructions Version:
Issue:

01.00.07
14.06.2024

Disclaimer

Publisher and copyright holder:

R. STAHL HMI Systems GmbH
Adolf-Grimme-Allee 8
D 50829 Cologne

T:	(Sales Support)	+49 221 768 06	- 1200
	(Technical Support)		- 5000
F:			- 4200
E:	(Sales Support)	sales.dehm@r-stahl.com	
	(Technical Support)	support.dehm@r-stahl.com	

- All rights reserved.
- This document may not be reproduced in whole or in part except with the written consent of the publisher.
- The information in this document is subject to change without notice.

Any warranty claims are limited to the right to demand amendments. Liability for any damage that might result from the contents of these instructions or all other documentation is limited to clear cases of premeditation.

We reserve the right to amend our products and their specifications at any time, provided it is in the interest of technical progress. The information in the current manual (online or on CD / DVD / USB-stick) or in the operating instructions included in the delivery applies.

Trademark







The terms and names used in this document are registered trademarks and/or products of the companies in question.

Copyright © 2024 by R. STAHL HMI Systems GmbH. Subject to alterations

Specific markings

The markings in these Operating Instructions refer to specific features that must be noted.

In detail, these are:

 DANGER	This sign alerts users to hazards that will result in death or serious injury if ignored.
 WARNING	This sign alerts users to hazards that may result in death or serious injury if ignored.
 CAUTION	This sign alerts users to hazards that may result in injury if ignored.
 CAUTION	Information highlighted by this symbol indicates measures for the prevention of damage to machinery or equipment.
 NOTE	Information highlighted by this symbol (with or without writing) indicates important information of which particular note should be taken.
 DOCUMENTATION	Information highlighted by this symbol (with or without writing) refers to a different chapter or section in this manual or other documentation or a web-page.

Warning

	<p>Warning !</p> <p>In ambient temperatures exceeding +45 °C the surface of the devices may heat up. Caution when touching!</p>
---	---

Symbols used in these Operating Instructions





Symbol	Meaning
	Work step, the number indicates the sequence in which the steps are to be carried out
	Indicator arrow (blue)
	Movement arrow (brown) indicating the movement that can be / is done with or to the material
	Turning movement, turning direction

Table of contents

	Description	Page
	Disclaimer	2
	Specific markings	3
	Warning	3
	Symbols used in these Operating Instructions	3
	Table of contents	4
1	Preface	6
2	Function of transmission unit	7
2.1	General	7
2.1.1	Device allocation	7
2.2	Notes on DVI2 and DVI3	7
2.3	Notes on DVI3	8
2.3.1	Resolutions	8
2.3.2	Caveat	8
2.3.3	Brightness adjustment	8
3	Type allocation	8
3.1	Type marking	8
4	Technical data	9
5	Conformity to standards	10
6	Certificates DVI1 and DVI3	11
	Europe (CE / ATEX)	11
	Global (IECEX)	11
	USA (CSA)	11
	Canada (CSA)	11
	China (CNEEx)	11
	Korea (KCC / KCS)	11
	Marine- / ship approval (DNV)	11
7	Marking	12
8	Permitted maximum values	13
8.1	External inherently safe optical interface	13
9	Type code	13
10	Safety information	14
10.1	General safety information	14
10.2	Warning note	14
10.3	Installation safety information	14
10.4	Industrial Security	15
10.5	Safety information for operation	15
11	Mechanical dimensions	16
11.1	KVM-DVI1	16
11.2	KVM-DVI2	16
11.3	KVM-DVI3	17
12	Assembly KVM-DVI3	18
12.1	Notes on assembly	18
12.2	Mounting types	18
12.3	Mounting on DIN rail	18

12.3.1	View	18
12.3.2	Dimensions	19
12.3.3	Components	19
12.3.4	Description of Assembly	20
12.4	Mounting in cabinet (19" frame)	22
12.4.1	View	22
12.4.2	Dimensions	23
12.4.3	Components	23
12.4.4	Description of assembly	24
13	Connections	26
13.1	KVM-DVI1	26
13.2	KVM-DVI2	28
13.3	KVM-DVI3	29
13.4	Connection diagram KVM-DVI3	31
13.4.1	KVM-DVI3 data connection to SERIES 600 devices	31
13.4.2	KVM-DVI3 connection to the host PC	33
13.4.3	Local display of the host PC at the KVM-DVI3	34
14	Maintenance, service	34
15	Troubleshooting	34
15.1	Repairs / hazardous substances	34
16	Disposal / restricted substances	35
16.1	Declaration of substances and restricted substances	35
16.1.1	Declarable substance groups	35
16.1.2	RoHS directive 2011/65/EC	35
16.1.3	IMO Resolution MEPC.269(68)	35
17	Control Drawing CEC / NEC	36
18	Declaration of EC conformity	38
18.1	EU	38
18.2	RCM	40
19	Release notes	42

1 Preface

These operating instructions contain all relevant information on the KVM transmission units for connection to HMIs of the series 600 KVM systems. They also contain information on the connection and installation (etc.) of these devices.

 NOTE	<p>All data relevant to explosion protection was copied to these operating instructions from the EC type examination certificate.</p>
	<p>For the correct operation of all associated components please note, in addition to these operating instructions, all other operating instructions enclosed in this delivery as well as the operating instructions of the additional equipment to be connected.</p>

 DOCUMENTATION	<p>Please note that the Ex certificates of the KVM transmission units are part of the certificates of the ET-xx7 HMI devices. You can find these certificates in a separate document (CE_ET-xx7) ! You can find this document online at www.r-stahl.com or request a copy from R. STAHL HMI Systems GmbH.</p>
--	---

2 Function of transmission unit

All transmission units (KVM box) are used for classic point-to-point data connection from a PC outside of the production area to an on-site HMI. The data transmission to the PC is via VGA/DVI or USB/PS2 and a copper or optical fibre connection to the on-site HMI, realised as digital data transfer. Depending on cable connection and transmission technology the distance between the transmission unit and the Remote HMI ranges from 140m (copper cable) to 10,000m (optical fibre).

The transmission technologies available are the KVM Classic versions DVI1, DVI2 and DVI3, for which the appropriate transmission units exist (see type code).

2.1 General

 NOTE	Please note: KVM transmission units must be selected to suit the series 600 KVM systems.
---	--

2.1.1 Device allocation

KVM transmission units	SERIES 600 KVM system
	Can be used with
KVM-DVI1-CAT	ET-/MT-/IT-6x7-DVI1-CAT-*
KVM-DVI1-MM-FO	ET-/MT-/IT-6x7-DVI1-MM-FO-*
KVM-DVI1-SM-FO	ET-/MT-/IT-6x7-DVI1-SM-FO-*
KVM-DVI2-CAT	ET-/MT-/IT-6x7-DVI2-CAT-*
KVM-DVI3-CAT	ET-/MT-/IT-6x7-DVI3-CAT-*
	ET-/MT-6x8-DVI3-1TX-*
KVM-DVI3-MM-FO	ET-/MT-/IT-6x7-DVI3-MM-FO-*
	ET-/MT-6x8-DVI3-1SX-*
KVM-DVI3-SM-FO	ET-/MT-/IT-6x7-DVI3-SM-FO-*
	ET-/MT-6x8-DVI3-1LX-*
KVM-DVI3-RU-CAT	Standard devices (screen, mouse, keyboard)
KVM-DVI3-RU-MM-FO	Standard devices (screen, mouse, keyboard)
KVM-DVI3-RU-SM-FO	Standard devices (screen, mouse, keyboard)

 DOCUMENTATION	* Any other device design of series 600, according to type code. See Operating Instructions for each HMI device series (ET-/MT-/IT-xx7 or ET-/MT-xx8).
--	---

2.2 Notes on DVI2 and DVI3

 NOTE	For the USB connection between the KVM transmission unit and the host PC make sure that the latter has a USB 2.0 chip set. More recent USB 3.0 chip sets may cause problems with the connection and function.
---	--

2.3 Notes on DVI3

2.3.1 Resolutions

The DVI3 transmission units represent all resolutions at a ratio of 1:1. The image at the HMI device is therefore always displayed with its actual size and there is no scaling.

If the resolution of the image displayed is smaller than the natural resolution of the HMI device display, a black margin will appear around the image.

Image resolution = display resolution

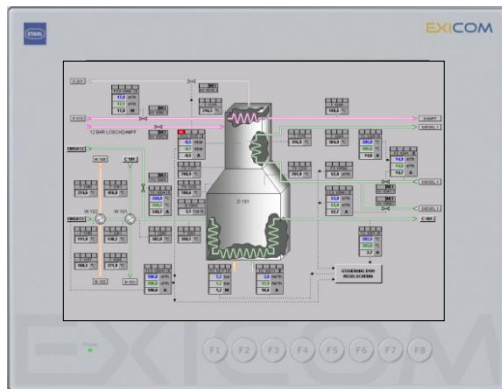
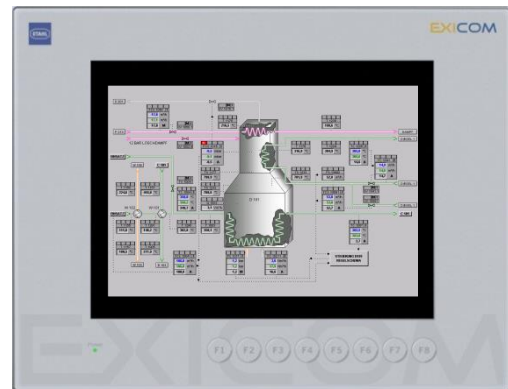

image resolution < display resolution



2.3.2 Caveat

Access to the host PC's BIOS via the KVM unit is not possible with all PC types. The BIOS has to support USB 2.0 (high speed) communication.

2.3.3 Brightness adjustment

The display brightness of the 6x7 HMI device is automatically reduced to 50% after 15 minutes without any operation. As soon as there is any activation via touch, button or keyboard the brightness level returns to 100%.

3 Type allocation

Since the beginning of 2013, the T series devices have undergone a change in type designation, so that the names of the devices are based on the existing scheme.

To avoid having to re-write certifications, the names in the certificates remain the same, but the devices receive new names.

In the interest of a clear link between device type and certificate, both device names are listed on the type plate from 01.04.2013 onwards.

3.1 Type marking

Old (certificate)	New
T-Ex-KVM*-CAT7*	KVM-*-CAT*
T-Ex-KVM*-MM*	KVM-*-MM*
T-Ex-KVM*-SM*	KVM-*-SM*

* = alphanumeric or symbolic characters without relevance to explosion protection.

= numeric character without relevance to explosion protection.

DOCUMENTATION

For the exact new device name and version please refer to the type code.

4 Technical data

Function / Equipment	KVM-DVI1-*	KVM-DVI2-*	KVM-DVI3-*
Power supply	via IEC plug (female)		
Voltage supply	100 - 240 VAC, 50 - 60 Hz		
Power	Typically 5 W / max. 10 W (typically 17 BTU / max. 34 BTU)		
Recommended fuses	1.0 AT		
MTBF	Typically 50,000 h at 20° C		
Power supply 2	Redundant connection, via mini-DIN / Hosiden plug	-	-
Voltage supply	12 VDC	-	-
Interfaces	Either copper or optical fibre		
Ethernet	Direct connection, Gigabit		
Copper (CAT)	Direct connection, Gigabit		
Optical fibre (MM-FO)	Direct connection, Gigabit, multi-mode intrinsically safe (Ex op is)	-	Direct connection, Gigabit, multi-mode intrinsically safe (Ex op is)
Optical fibre (SM-FO)	Direct connection, Gigabit, single mode intrinsically safe (Ex op is)	-	Direct connection, Gigabit, single mode intrinsically safe (Ex op is)
DVI	1 x DVI, 1 x DVI / VGA	1 x DVI-D in, 1 x DVI-D out	1 x DVI-I in, 1 x DVI-I out
USB	1 x plug type B	1 x plug type B	1 x plug type B
PS/2	2 x mouse, 2 x keyboard	-	-
Serial	RS-232	via USB / RS-232 converter	RS-232
Audio	Line in / out	via USB / Audio converter	Line in / out
Data cable	CAT7 installation cable AWG 23		
Copper (CAT)	50 or 62.5 / 125 µm (core / external cross section) multi-mode optical fibre cable		
Optical fibre (MM-FO)	9 / 125 µm (core / external cross section) single-mode optical fibre cable		
Optical fibre (SM-FO)	9 / 125 µm (core / external cross section) single-mode optical fibre cable		
Data cable lengths			
Copper (CAT)	140 m	500 m	150 m
Optical fibre (MM-FO)		-	
50 µm core	550 m	-	550 m
62.5 µm core	300 m	-	300 m
Optical fibre (SM-FO)	10,000 m	-	10,000 m
Enclosure	Desktop enclosure, aluminium		
Enclosure protection type	IP20		
Operating temperature range			
Cold start temperature	+5 °C ... +40 °C	-10 °C ... +50 °C	
Operation	+5 °C ... +40 °C	-20 °C ... +50 °C	
Short-term temperature	+5 °C ... +40 °C	-30 °C ... +60 °C	
Storage temperature range	-20 °C ... +70 °C	-20 °C ... +70 °C	
Relative humidity	20 to 80% at +40°C, non-condensing	10 to 90% at +40°C [+104 °F], non-condensing	
Dimensions [mm] (W x H x D)	210 x 44 x 210	210 x 44.45 x 165	210 x 44.45 x 165
Weight [kg]	1.0		



When using the FO interfaces of the KVM devices, they have to be connected and securely operated with other devices that comply with Class 1 limits according to IEC 60825-1, or are classed as "op is" inherently safe according to IEC 60079-28.

5 Conformity to standards

The KVM transmission units comply with the following standards and directive:

Standard	Classification
2st supplement	
ATEX Directive 2014/34/EU	
EN 60079-0 : 2009	General requirements
EN 60079-26 : 2007	Device protection (EPL) "Ga"
EN 60079-28 : 2004	Optical radiation
The product complies with the requirements pursuant to:	
EN 60079-0 : 2012 + A11 : 2013	General requirements
EN IEC 60079-0 : 2018	
EN 60079-26 : 2015	Device protection (EPL) "Ga"
EN 60079-28 : 2016	Optical radiation
Electromagnetic compatibility	
EMC Directive	
2014/30/EU	Classification
EN 61000-6-2 : 2005	Immunity
EN 61000-6-4 : 2007 + A1 : 2011	Emitted interference
Low voltage directive	
Directive 2014/35/EU	
EN 61010-1 : 2001+	General requirements
DIN EN 62368-1 : 2016 IEC 62368-1 : 2014	Devices for audio / video, information and communication technology - safety requirements
RoHS Directive	
2011/65/EU	Classification
EN IEC 63000 : 2018	Technical documentation for the assessment of electrical and electronic equipment with regard to the restriction of hazardous substances

6 Certificates DVI1 and DVI3

 **NOTE** Of all associated equipment only the KVM transmission units with an optical fibre interface have a corresponding certificate.

Synonym	Scope of validity	Certificate number	Valid until	Note
CE	Europe		unlimited	according to directive 2014/30/EU; 2014/35/EU
ATEX	Europe	BVS 11 ATEX E 102 X	unlimited	
IECEX	Global	IECEX TUR 11.0075X	unlimited	
NEC	USA	CSA 70011698	unlimited	
CEC	Canada		unlimited	
CNEx	China	CNEx21.1940X	16.06.2026	
KCC	Korea		unlimited	for device restrictions see note KCC
KCS		12-GA4BO-0617X	unlimited	see note KCS
DNV	Marine / ship approval	TAA00000BK	21.12.2026	see note DNV



 **NOTE** Note on certificates:
The certificates of the KVM transmission units (FO versions) are part of the certificates of the ET-xx7 HMI devices.

 **NOTE** Note KCC:
In order to be able to operate these KVM transmission units in Korea, each device type also requires a KCC certificate.
The following KVM transmission units currently have such a KCC certificate:
T-Ex-KVM-DVI3 (KVM-DVI3-*)
For Korea, the importer has to provide a special exception document as described in the Korean regulation.
A sample document, the so-called "Customer confirmation letter", is included in the certificate collection CE_ET-xx7 for the ET-xx7 HMI devices.

 **NOTE** Note KCS and DNV:
Certificate only valid for KVM-DVI3-* transmission units !

 **DOCUMENTATIO** You can access all IECEx certificates on the official website of the IEC under their certificate number.
<https://www.iecex-certs.com/#/home>.

7 Marking

Manufacturer	R. STAHL HMI Systems GmbH	
Type designation	KVM-DVI1-MM-FO* / KVM-DVI1-SM-FO*	
	KVM-DVI3-MM-FO* / KVM-DVI3-SM-FO*	
CE classification:	 0158	
Testing authority and certificate number:	BVS 11 ATEX E 102 X	
Ex classification:		
ATEX		II (1) G [Ex op is Ga] IIC II (1) D [Ex op is Da] IIIB
IECEx		[Ex op is Ga] IIC [Ex op is Da] IIIB
CNEx		[Ex op is Ga] IIC [Ex op is Da] IIIB

8 Permitted maximum values

Input:
Max. operating voltage U_m ≤ 250 VAC

8.1 External inherently safe optical interface

Ethernet optical fiber (MM-FO)
Multi mode

Wavelength 850 nm
Radiant power 0.22 mW
max. radiant power: 35 mW

Ethernet optical fibre (SM-FO)
Single mode

Wavelength 1310 nm
Radiant power 0.22 mW
max. radiant power: 35 mW

9 Type code

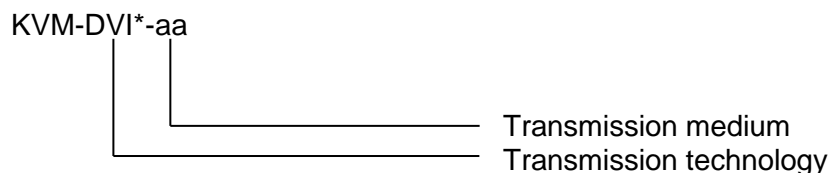

Product type:

Product key structure	Description
	Variant
KVM-DVI1-CAT	KVM box with DVI1 transmission technology, copper direct connection, no longer available
KVM-DVI1-MM	KVM box with DVI1 transmission technology, direct optical fibre connection, multi-mode, no longer available
KVM-DVI1-SM	KVM box with DVI1 transmission technology, direct optical fibre connection, single mode, no longer available
KVM-DVI2-CAT	KVM box with DVI2 transmission technology, copper direct connection, no longer available
KVM-DVI3-CAT	KVM box with DVI3 transmission technology, copper direct connection, Gigabit
KVM-DVI3-MM-FO	KVM box with DVI3 transmission technology, direct optical fibre connection, multi-mode
KVM-DVI3-SM-FO	KVM box with DVI3 transmission technology, direct optical fibre connection, single-mode
KVM-DVI3-RU-CAT	KVM box with DVI3 transmission technology, non-Ex receiving unit, copper direct connection, Gigabit
KVM-DVI3-RU-MM-FO	KVM box with DVI3 transmission technology, non-Ex receiving unit, direct optical fibre connection, multi-mode
KVM-DVI3-RU-SM-FO	KVM box with DVI3 transmission technology, non-Ex receiving unit, direct optical fibre connection, single-mode

10 Safety information

10.1 General safety information

- It is important that you adhere to all relevant accident prevention rules and the regulations concerning electrical installations during installation, maintenance and operation. Everyone involved in the installation, commissioning and maintenance of this device and its accessories has to be qualified accordingly and must be familiar with the contents of this manual and associated documents.
- In case of non-compliance or contravention of the above explosion-protection is no longer guaranteed and all warranty claims shall be null and void.
- National safety and accident prevention rules must be observed.
- Use the equipment for its intended purpose only.
- No changes to the device are permitted. The device may only be opened by R. STAHL HMI Systems GmbH.

10.2 Warning note



This is a Class A product.

In a domestic environment this product may cause radio interference in which case the user may be required to take adequate measures.

10.3 Installation safety information

- National assembly and installation rules and the generally accepted rules of technology must be observed. Connect and operate the device according to applicable standards, regulations and installation instructions. Only qualified or suitably instructed staff may install the device.
- Only use suitable tools for the installation.
- The units must be earthed via the bolt at the back of the device.
- We recommend you use screened cables with the device. Routing of the data cable may impair performance.
- The maximum voltage of 250 V and a short current of 1500 A must not exceed at the place of installation.
- Before starting up the device ensure that it has been installed according to regulations and that neither the device nor its cables are damaged.

10.4 Industrial Security

Our products with Industrial Security functions support the secure operation of plants, systems and equipment. Protection against cyber threats requires an all-encompassing industrial security concept. The key to a successful concept is integrated implementation, continuous maintenance and state-of-the-art technology. This is the responsibility of the plant operator.

The following are key issues for an effective industrial security concept:

- Prevention of unauthorised access to plants, systems, equipment and networks
- Systems, equipment and components should only be connected to the company intranet or the internet if and when required
- Employ protective measures such as firewalls and network segmentation
- Only use the latest software product versions
- Carry out software updates as soon as new updates are available
- Use standard user accounts for regular operation
- Use secure passwords
- Appropriate safeguarding of administrator accounts
- Application of security guidelines
- Other measures to be taken as required

R. STAHL uses Windows 10 for its products. The company does not develop any cryptographic functions. Neither does the company create any system configuration / system hardening software, provide security guidelines for these, nor does it refer to any such guidelines. Moreover, R. STAHL is constantly working on enhancing its products, thereby contributing to system security and to minimizing the risk of cyber threats.

10.5 Safety information for operation

- The device may only be operated in an undamaged and clean condition. If the device is in any way damaged, do not touch it to avoid injury. In the case of any damage that may compromise ingress protection (e.g. cracks, holes or broken components) the device must be taken out of commission immediately. Before the device is recommissioned the damaged components must be replaced.
- In case of non-compliance or contravention of the above explosion-protection is no longer guaranteed and all warranty claims shall be null and void.

11 Mechanical dimensions

11.1 KVM-DVI1

View:

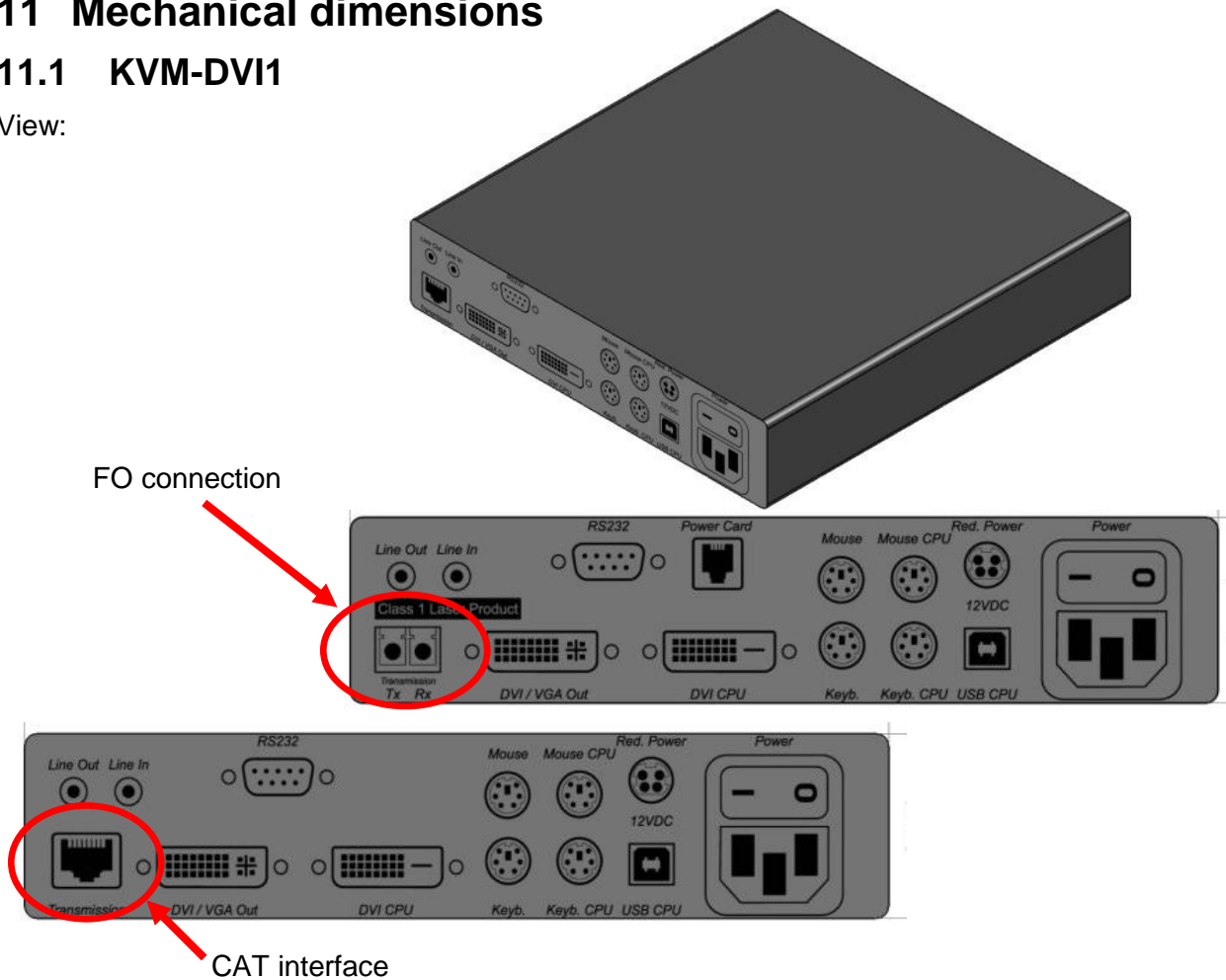

Dimensions in mm:
210 x 44 x 210 cm (W x H x D)

11.2 KVM-DVI2

View:

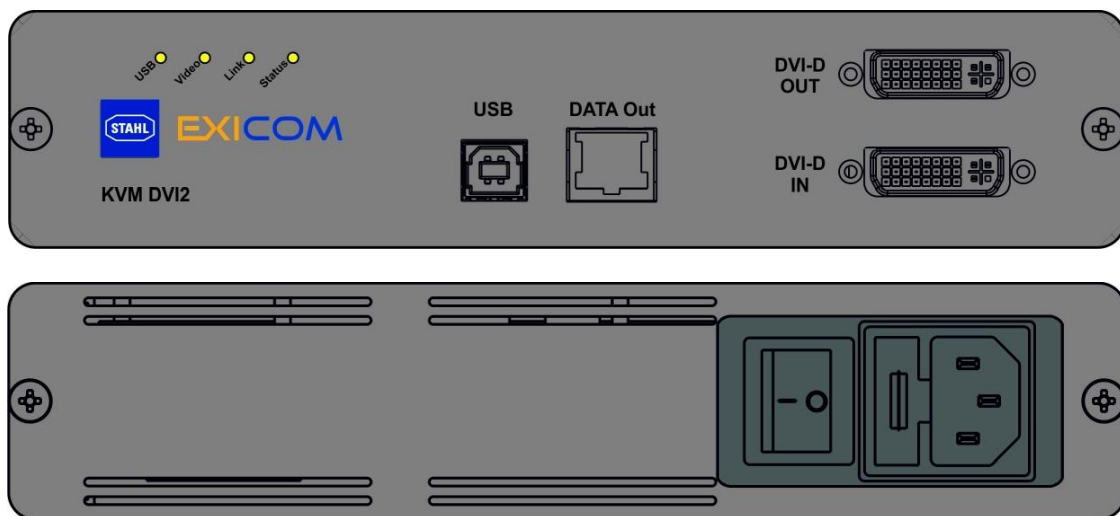

Dimensions in mm:
210 x 44.45 x 165 cm (W x H x D)

11.3 KVM-DVI3

View (CAT version):

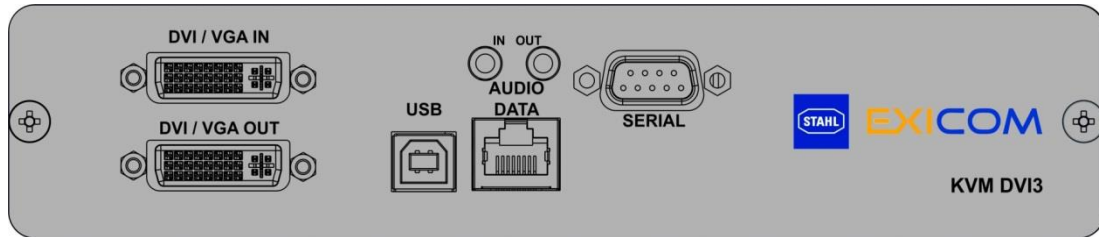

View (optical fibre version):

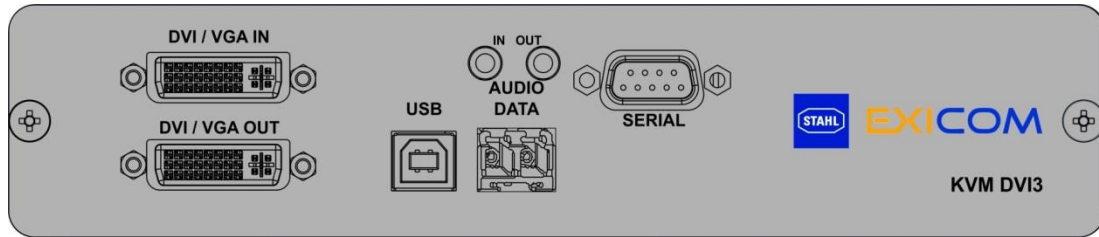

Back view:

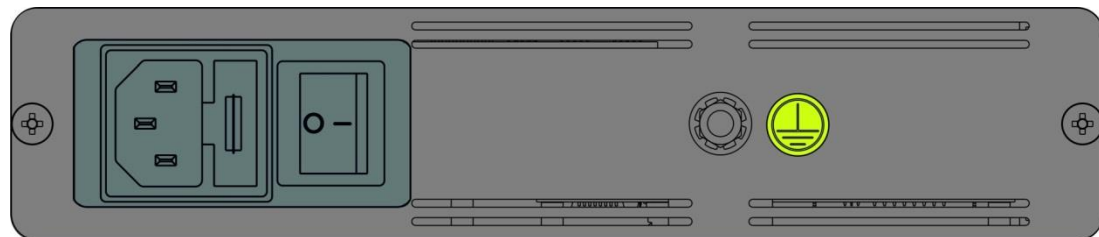

Dimensions in mm:
210 x 44.45 x 165 cm (W x H x D)

12 Assembly KVM-DVI3

12.1 Notes on assembly

Observing the following points will ensure a professional and safe assembly and installation:

- Only use threads or holes already present in the enclosure.
- Mount the device carefully and strictly in accordance with the safety notes (see chapter [10 Safety information](#)).
- Study the installation conditions and assembly instructions in these operating instructions carefully and follow them to the letter.
- The devices may only be installed and operated in an undamaged, dry and clean condition.
- National assembly and installation rules and the generally accepted rules of technology must be observed. The device and its accessories must be installed and operated according to applicable standards, directives and installation guidelines.
- Mount and install the device in such a way that it is always operated within the permissible temperature range.

12.2 Mounting types

The devices can be used as a tabletop device, mounted on a DIN rail or inside a cabinet (19" frame).

12.3 Mounting on DIN rail



A special DIN Rail Kit is available for mounting on a DIN rail
(SAP 229325 – DVI2-DVI3-DINrailKit)

12.3.1 View

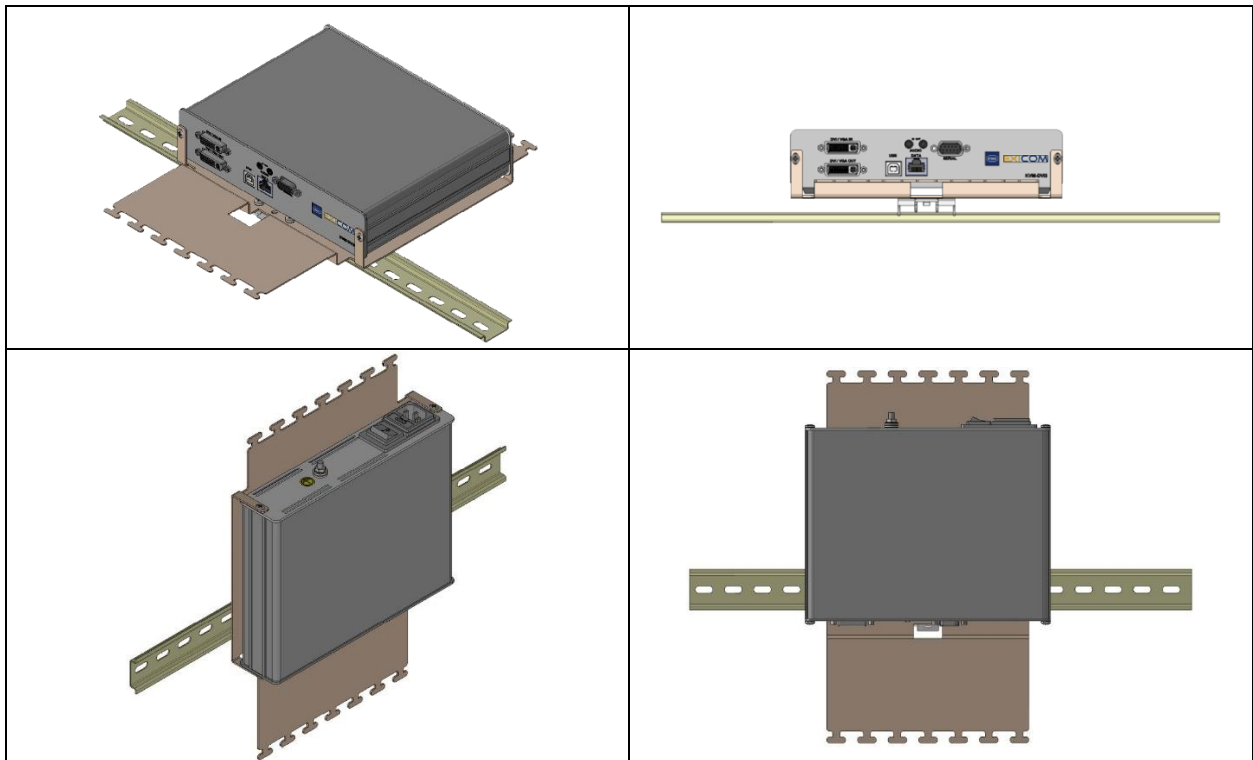

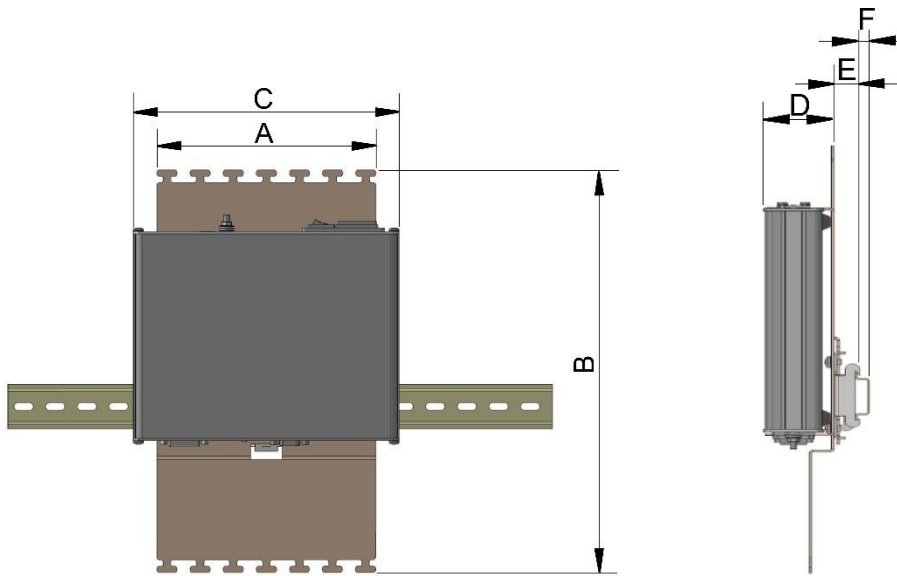

12.3.2 Dimensions

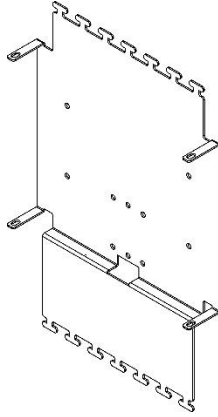

Dimensions (mm)					
A	B	C	D	E	F
173	318	210	52.1	13.7	5.2

12.3.3 Components

Designation	Image	Number
DIN fastening Schneider AX2-DL01		1
Retaining plate for DINRailKit DVI2/DVI3		1
Cross-head combined screw M4 x 6		4

12.3.4 Description of Assembly

- Screw AX2-DL01 fastening to the back of the retaining plate with 4x combination screw

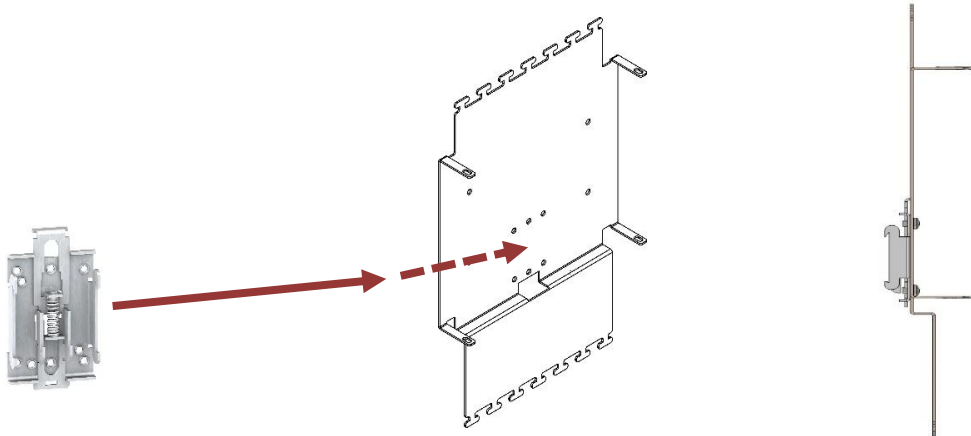

- Clip mounted fastening onto DIN rail

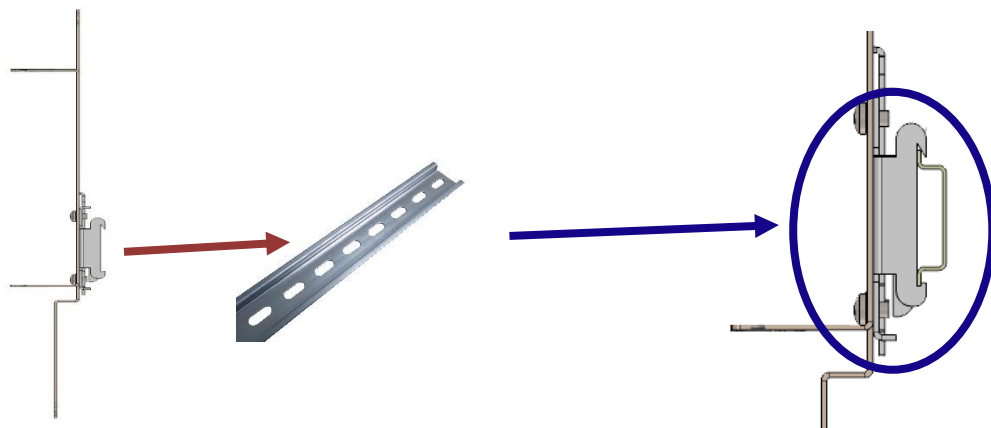

- Remove KVM box screws at front and back

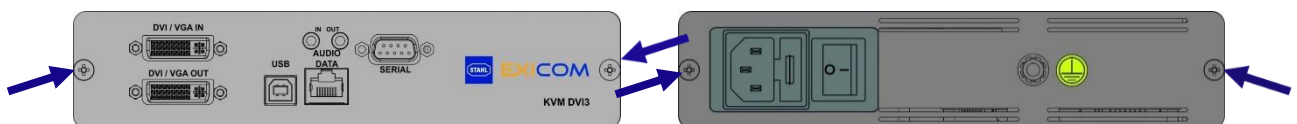

! Once the screws have been removed, the enclosure may become loose.

- Slide KVM box between the attachment brackets of the retaining plate, preferred orientation front down

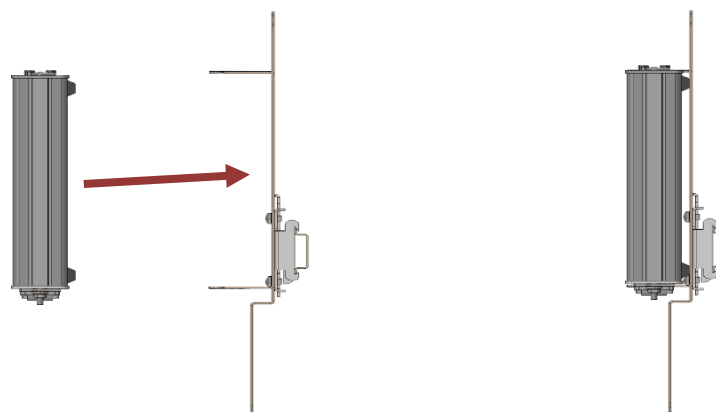

- Fix KVM box with the screws at top and bottom

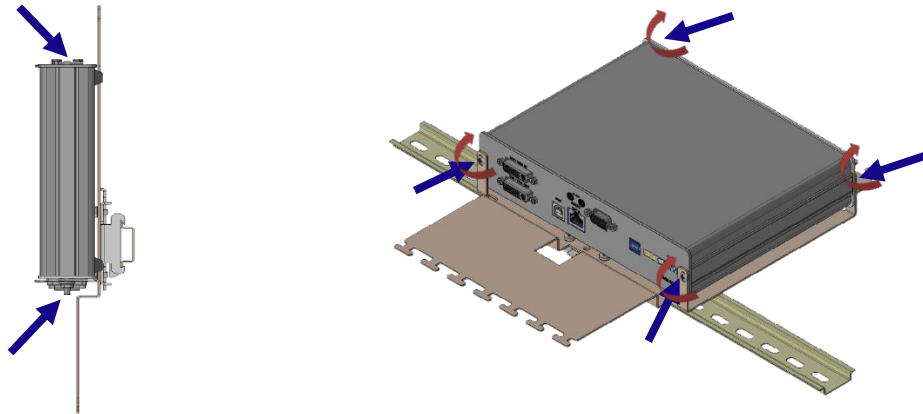

- Connect (1) and possible fix (2) required cables (image shows screen cable as example), lash cables with cable ties to the ears of the retaining plate (3) for strain relief.

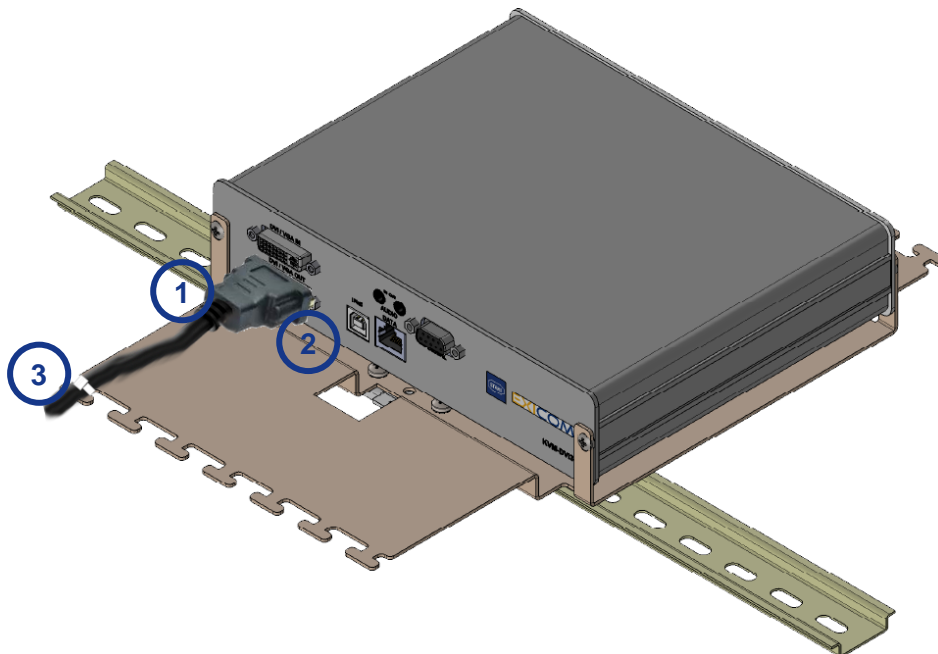

12.4 Mounting in cabinet (19" frame)



Specific mounting kits are available for mounting the device in a cabinet (19" frame) (SAP 221095 - DVI3-RackMountKit-1, SAP 221096 - DVI3-RackMountKit-2)

12.4.1 View

1x KVM-DVI3, 1x cover

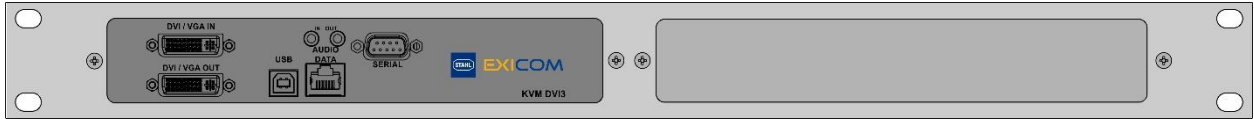

2x KVM-DVI3

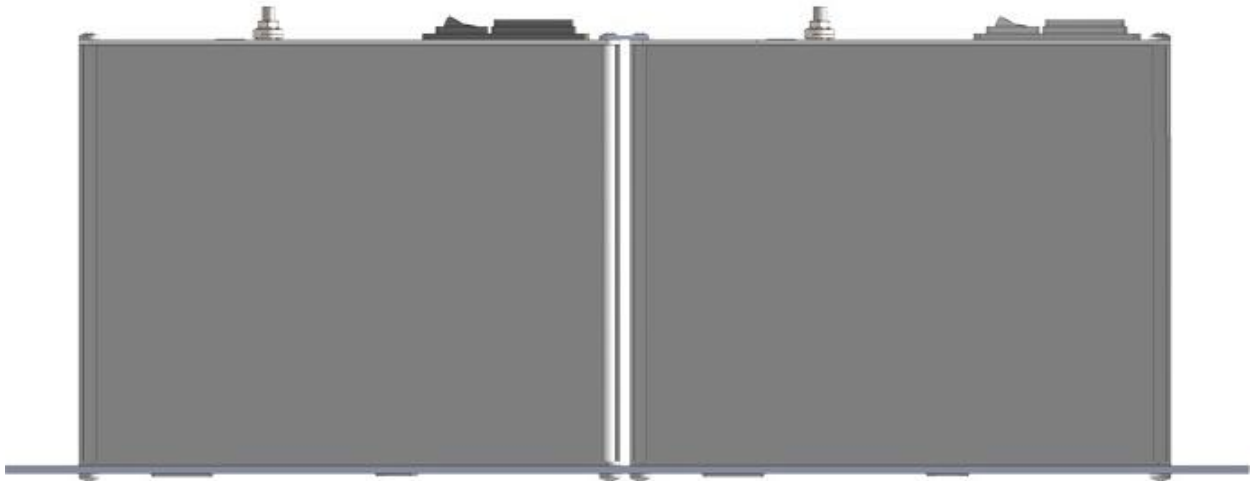
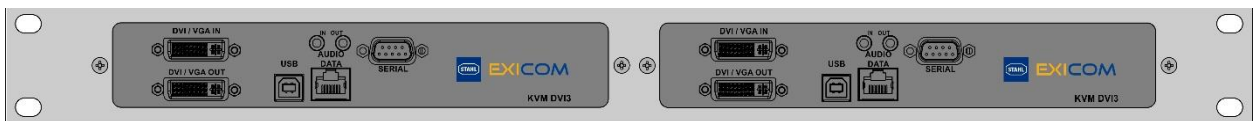

12.4.2 Dimensions

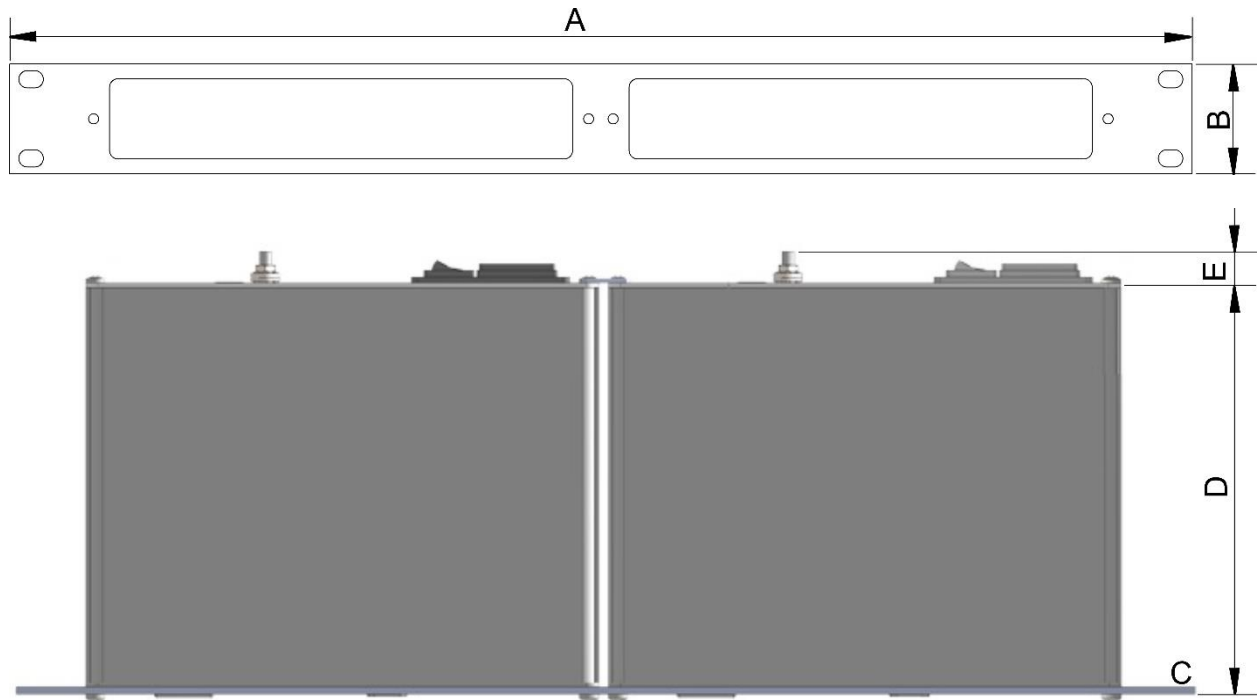

Dimensions (mm)				
A	B	C	D	E
482.6	44.45	3 *	168	13



! * The C fixing frame has a thickness of 3 mm.

12.4.3 Components

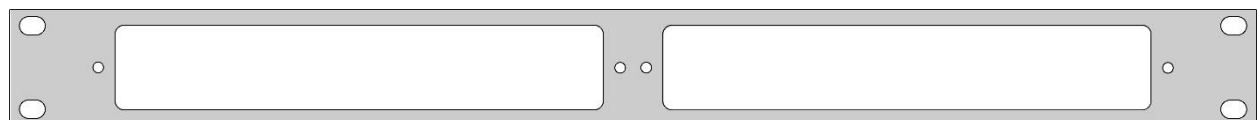

19" fixing frame for 2x KVM-DVI3



M6 cage nut set, consisting of:

4x cage nut	4x plastic washer	4x cross-head screw
		

Cover set, consisting of:

Cover with M4 insert nut	2x Torx lens head screw M4 x 10
	

! Cover set only part of SAP 221095 - DVI3-RackMountKit-1 mounting kit.

12.4.4 Description of assembly

- Place cage nuts at the required position at the back of the rack and arrest. Choose distance according to the hole pattern of the mounting frame.

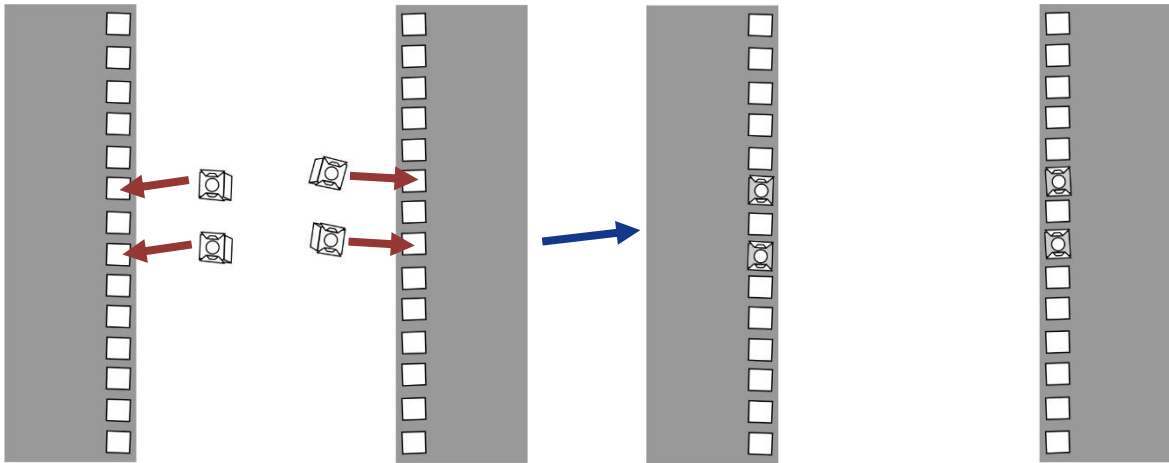

- Fix mounting frame on both sides using cross-head screws and plastic washers (4x)

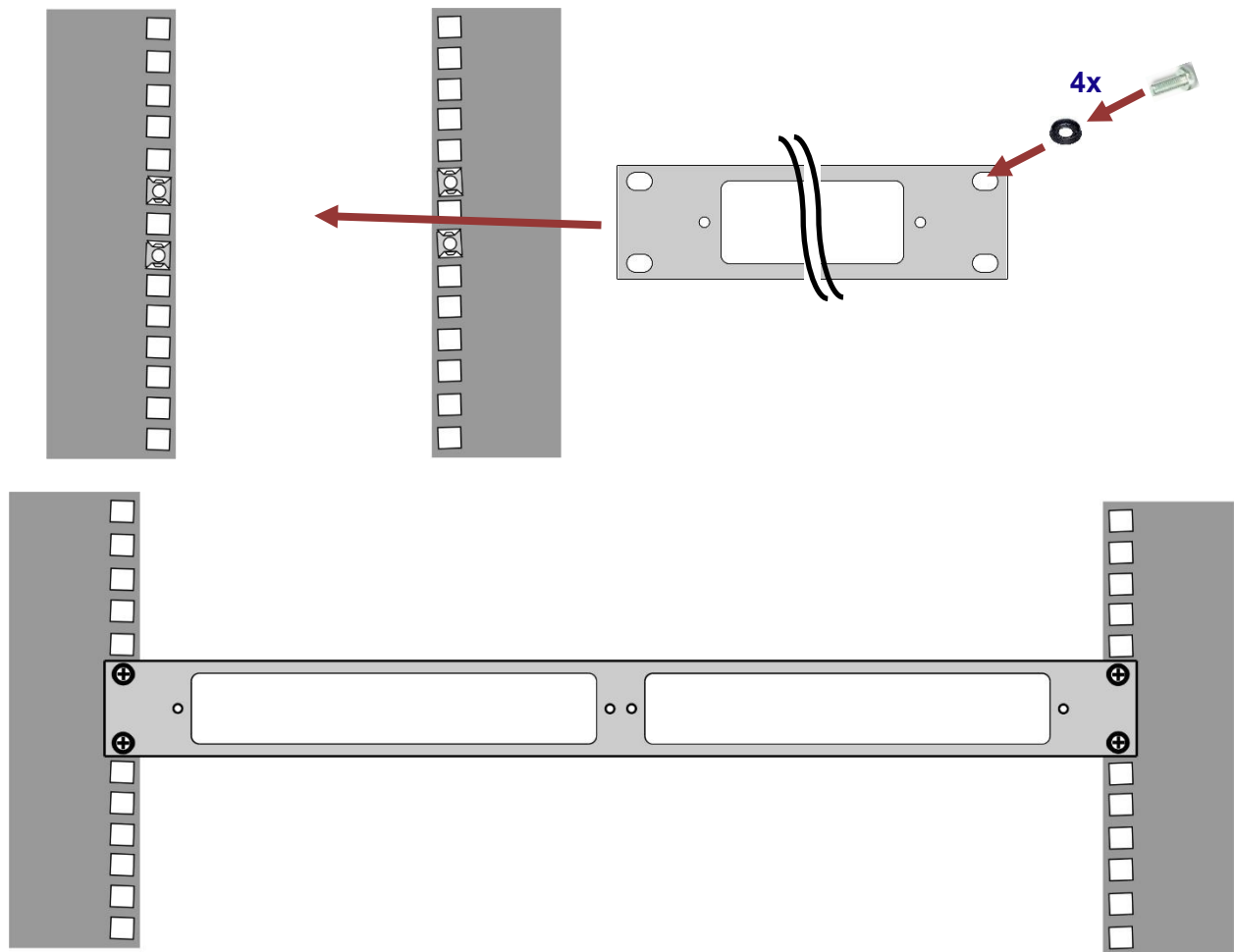

- Remove screws at the front of the KVM box

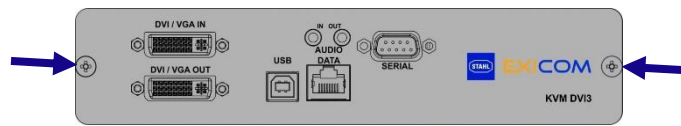

- Place KVM box at the back of the mounting frame and secure with screws

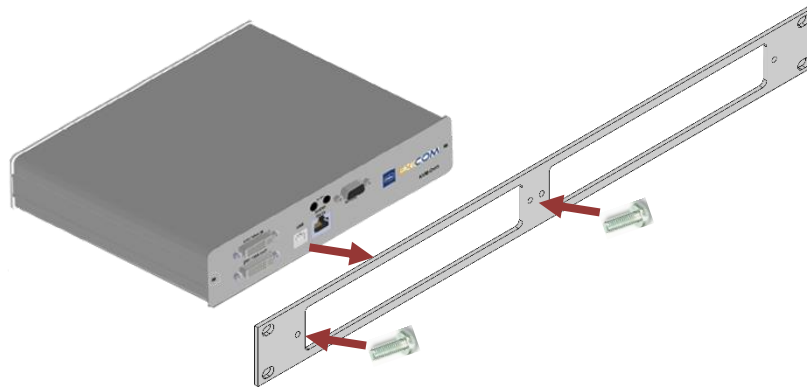



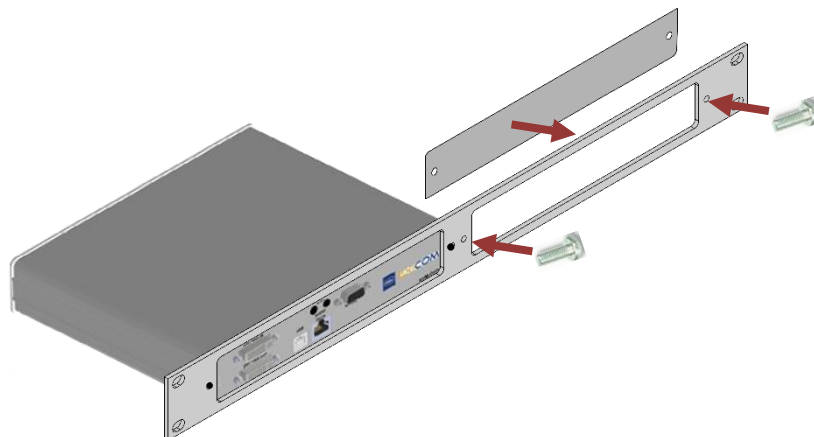





- Close remaining space of frame cut-out with cover and screw tight

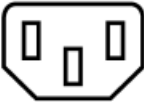

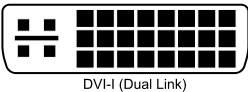
The KVM box can be mounted both on the left (as in illustration) and on the right of the mounting frame.
The mounting process is the same as the one described.
Instead of the cover a second KVM box can be mounted (proceed as described).

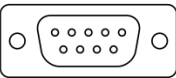
13 Connections

13.1 KVM-DVI1

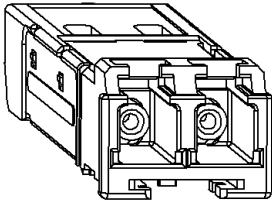
Designation	Plug type	Connection	Meaning
Power		IEC connector	Power supply 100 - 240 VAC of the KVM transmission unit
Red. power		Mini-DIN / Hosiden connector	Redundant 12 VDC supply of the KVM transmission unit
DVI CPU	 DVI-D (Dual Link)	DVI-D connector	DVI screen in, connection to the PC
DVI / VGA out	 DVI-I (Dual Link)	DVI-I connector	DVI / VGA screen out, connection to local screen
USB CPU		USB plug type B	USB in, connection to the PC
Mouse CPU	-	PS/2	not used / not supported
Keyb. CPU	-	PS/2	not used / not supported
mouse	-	PS/2	not used / not supported
Keyb.	-	PS/2	not used / not supported
RS232		Sub-D 9 pin socket	RS-232 interface
Line out		3.5 mm TRS socket	Audio out
Line in		3.5 mm TRS socket	Audio in
Transmission	 1.....8	RJ45 connector	Ethernet copper connection *
	Pin	Signal	Typical colour coding
	1	TRD0+	Orange / white
	2	TRD0-	Orange
	3	TRD1+	Green / white
	4	TRD1-	Blue
	5	TRD2+	White / blue
	6	TRD2-	Green
	7	TRD3+	White / brown
	8	TRD3-	Brown
	9	SHLD	Screen
Transmission	 Tx Rx	Optical fibre connection type LC Duplex connector	Ethernet optical fibre interface * Ex op is

 NOTE

* Please note that the Ethernet connection is designed **either** for an optical fibre connection (FO) or for a copper connection (CAT7), depending on the version ordered !

In the case of an optical fibre connection the following cable is recommended:





Multi-mode: 50 µm core cross section and 125 µm external cross section

Single-mode: 9 µm core cross section and 125 µm external cross section

When using the FO interfaces of the KVM devices, they have to be connected and securely operated with other devices that comply with Class 1 limits according to IEC 60825-1, or classed as "op is" inherently safe according to IEC 60079-28.





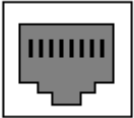

recommended cable length for USB, RS-232 and Audio:
max. 3 m

13.2 KVM-DVI2

Designation	Plug type	Connection	Meaning
Power		IEC connector	Power supply 100 - 240 VAC of the KVM transmission unit
DVI-D in	 DVI-D (Dual Link)	DVI-D connector	DVI screen in, connection to the PC
DVI-D out	 DVI-D (Dual Link)	DVI-D connector	DVI screen out, connection to local screen
USB		USB plug type B	USB in, connection to the PC
Data out	 1.....8	RJ45 connector	Ethernet copper connection
	Pin	Signal	Typical colour coding
	1	TRD0+	Orange / white
	2	TRD0-	Orange
	3	TRD1+	Green / white
	4	TRD1-	Blue
	5	TRD2+	White / blue
	6	TRD2-	Green
	7	TRD3+	White / brown
	8	TRD3-	Brown
	9	SHLD	Screen

! NOTE	Audio and RS-232 only via a corresponding USB converter.
---------------	--

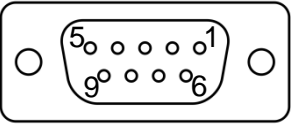
13.3 KVM-DVI3

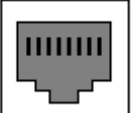
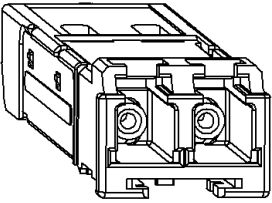
Designation	Plug type	Connection	Meaning	
Power		IEC connector	Power supply 100 - 240 VAC of the KVM transmission unit	
DVI / VGA in	 DVI-I (Dual Link)	DVI-I connector *	DVI / VGA screen in, connection to the PC	
DVI / VGA out	 DVI-I (Dual Link)	DVI-I connector *	DVI/VGA screen out, connection to local screen	
USB		USB plug type B	USB in, connection to the PC	
Serial		Sub-D 9 pin socket**	RS-232 interface	
		Pin	Signal	Designation
		2	RxD	Receive data
		3	TxD	Transmit data
		4	DTR	Data terminal ready
		5	GND	Ground
8	CTS	Clear to send		
Audio out		3.5 mm TRS socket	Audio out	
Audio in		3.5 mm TRS socket	Audio in	
Data	 1.....8	RJ45 connector	Ethernet (OSI Layer 1) copper interface ***	
		Pin	Signal	Typical colour coding *4
		1	TRD0+	Orange / white
		2	TRD0-	Orange
		3	TRD1+	Green / white
		4	TRD1-	Blue
		5	TRD2+	White / blue
		6	TRD2-	Green
		7	TRD3+	White / brown
		8	TRD3-	Brown
9	SHLD	Screen		
Data	 Tx Rx	Optical fibre connection type LC Duplex connector	Ethernet (OSI Layer 1) optical fibre interface *** Ex op is	

 NOTE	<p>It is also possible to use a single link connection for the DVI connection.</p> <p>** The named signals at the Sub-D socket are supported by the systems.</p> <p>*** Please note that the Ethernet connection is designed either for an optical fibre connection (FO) or for a copper connection (CAT7), depending on the version ordered ! In the case of an optical fibre connection the following cable is recommended:</p> <ul style="list-style-type: none">Multi-mode (MM)<ul style="list-style-type: none">50 µm core cross section and 125 µm external cross sectionSingle mode (SM):<ul style="list-style-type: none">9 µm core cross section and 125 µm external cross section <p>Data cable lengths:</p> <ul style="list-style-type: none">Optical fibre MM<ul style="list-style-type: none">up to 500 m via 50 / 125 µm FO cable,up to 300 m via 62.5 / 125 µm FO cableOptical fibre SM<ul style="list-style-type: none">up to 10,000 m via 9 / 125 µm FO cableCopper (TX)<ul style="list-style-type: none">up to 150 m via CAT7 installation cable AWG22 <p>When using the FO interfaces of the KVM devices, they have to be connected and securely operated with other devices that comply with Class 1 limits according to IEC 60825-1, or classed as "op is" inherently safe according to IEC 60079-28.</p> <p>*4 Colour coding acc. to EIA/TIA T568B recommended cable length for USB, RS-232 and Audio: max. 3 m</p>
---	---

13.4 Connection diagram KVM-DVI3

13.4.1 KVM-DVI3 data connection to SERIES 600 devices

The SERIES 600 HMI device is connected to the KVM transmission unit via an Ethernet connection which can consist of copper (Tx) or optical fibre (MM / SM) - depending on the version ordered.

13.4.1.1 Ethernet copper (Tx) connection

Ethernet connection Tx
 ET-/MT-6x7 at X16
 ET-/MT-6x8 at X2

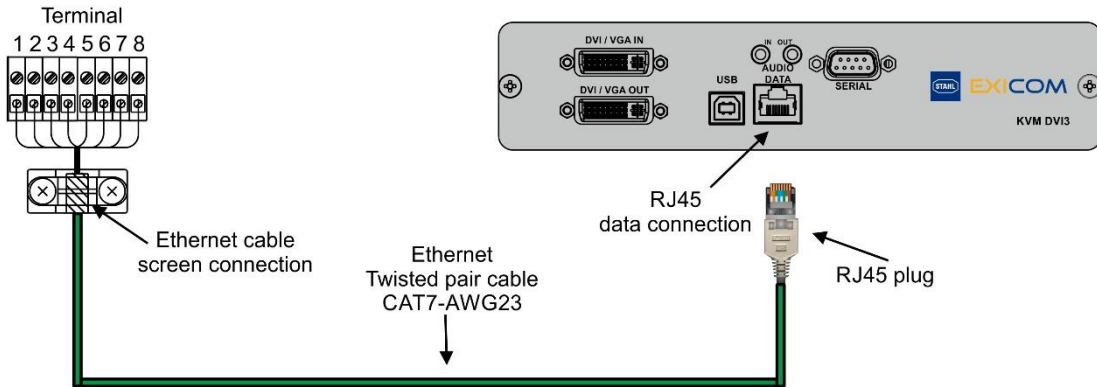

13.4.1.1.1 Terminal assignment copper (Tx) connection

Diagram of cable connection between the HMI device and the KVM transmission unit DVI3; colour coding according to EIA/TIA T568B.

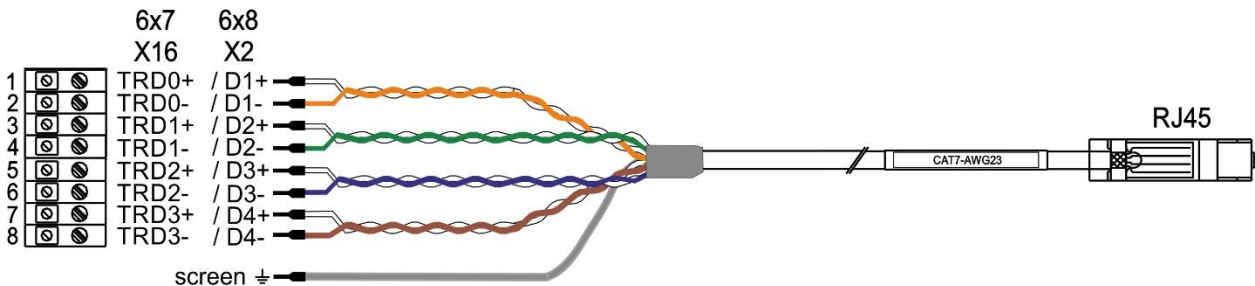

View / assignment of the RJ45 plug:

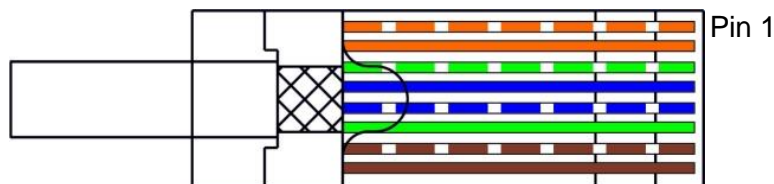

NOTE

Please note:
 The wire pairs must be twisted right up to the terminals of the HMI device !

Keep the cable wires as short as possible.

Ensure that the shielding of the cable covers a wide area.

13.4.1.1.2 LED function copper (Tx) connection

The LEDs for the state of the data connection of the Ethernet copper connection are located at the RJ45 socket.

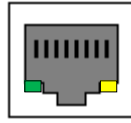

LED (colour)	LED status		
	Off	Blinking	On
Yellow	No voltage at KVM-DVI3	Data connection interrupted	Data connection on
Green	No DVI / VGA signal	Activity at USB connection	DVI / VGA signal exists

13.4.1.2 Ethernet optical fibre (MM / SM) connection:

Flip both optical fibre cables at one end so that the Tx signal is connected to the Rx signal, and the Rx signal to the Tx signal.

ET-/MT-/IT-6x7:

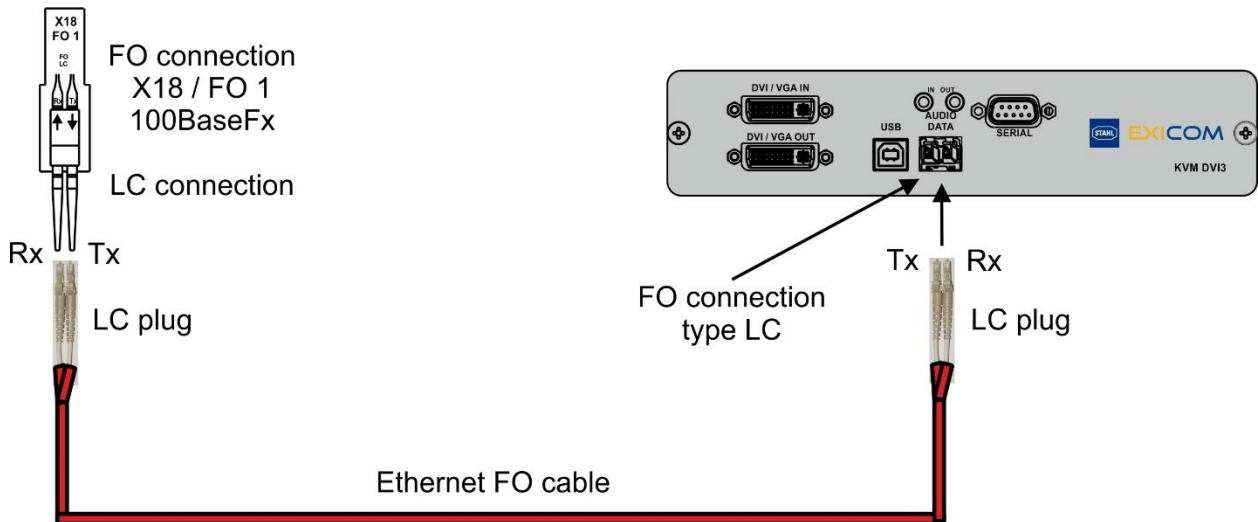

ET-/MT-6x8:

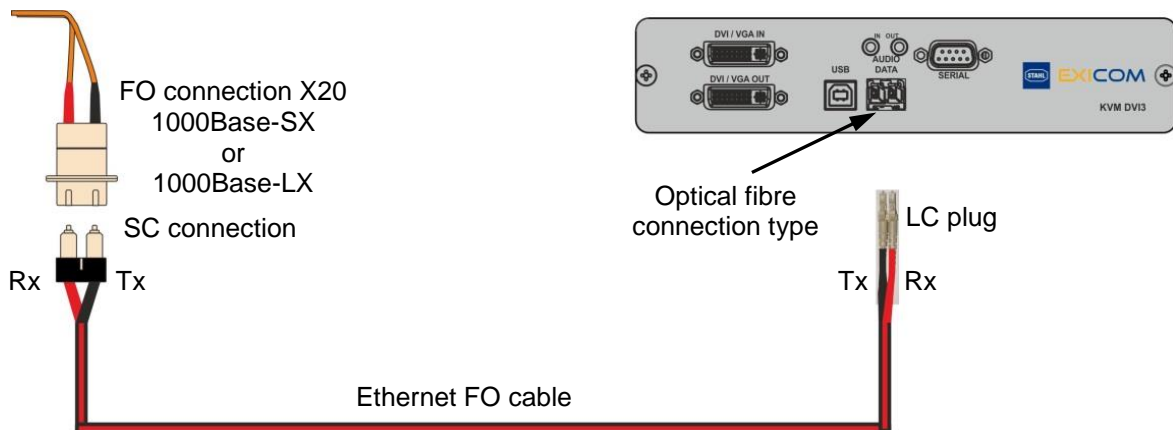

13.4.2 KVM-DVI3 connection to the host PC

Displaying the screen content and to operating the host PC require signal cables for the video, mouse and keyboard signals in addition to the power connection of the KVM transmission unit. Use the DVI / VGA IN socket for the video signal of the host PC.

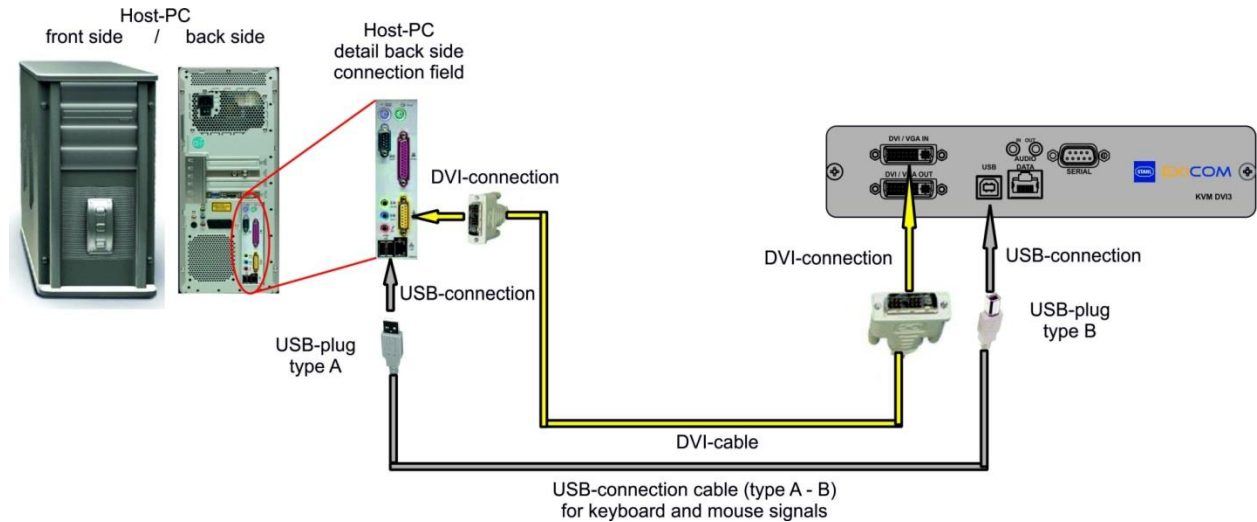

If the host computer has no DVI video signal, the KVM transmission unit can also be connected via a VGA video signal and cable. In this case, however, each host PC resolution used requires a video calibration of the KVM transmission unit.

A VGA-DVI adapter is required because the KVM transmission unit only has a DVI connector.

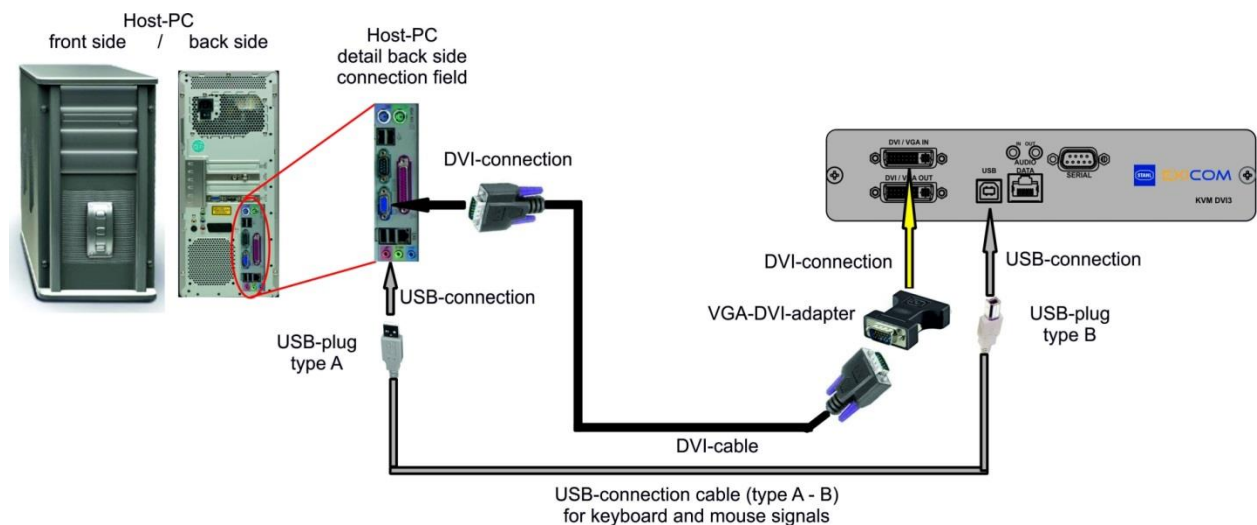

13.4.3 Local display of the host PC at the KVM-DVI3

If a local display of the host PC at the KVM transmission unit is required, a screen needs to be connected to the DVI / VGA OUT socket of the transmission unit.

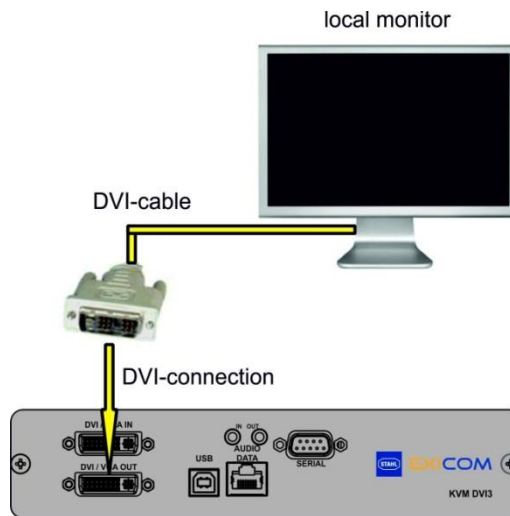

14 Maintenance, service

Because the transmission of the devices remains reliable and stable over long periods of time, regular adjustments are not required.

The following must be checked during maintenance work:

- a. Damage to enclosure
- b. All cables and lines are properly connected and undamaged

⚠ CAUTION

In case of damage or modification to the delivery state, immediately decommission the unit and contact R. STAHL HMI Systems GmbH.

15 Troubleshooting

! NOTE

Devices operated in hazardous areas must not be modified. Repairs may only be carried out by qualified, authorized staff specially trained for this purpose.

Repairs may only be carried out by specially trained staff who are familiar with all basic conditions of the applicable user regulations and – if requested – have been authorized by the manufacturer.

15.1 Repairs / hazardous substances

Devices returned to R. STAHL HMI Systems GmbH for repair must be accompanied by an error description.

Remove any residual substances. Take particular care with seal notches and slits to which residual substances might adhere. We have to ask you to not return any devices for which you cannot be absolutely sure that any hazardous substance residues have been completely removed. We shall bill the owner of the device for any costs arising from insufficiently cleaned devices, such as disposal or damage to persons (chemical burns, etc.).

16 Disposal / restricted substances

Disposal of old electric and electronic devices, packaging and used parts is subject to regulations valid in the country in which the device has been installed.

For countries under the jurisdiction of the EU the corresponding WEEE directive applies.

The devices are classified according to the table below:

Directive	WEEE II Directive 2012/19/EU
Valid	from 2018.08.15
Category	SG5 small devices < 50 cm

R. STAHL HMI Systems GmbH meets the requirements of directive 2012/19/EU (WEEE) and is registered under the number DE 15180083.

We shall take back our devices according to our general terms and conditions.

16.1 Declaration of substances and restricted substances

The present declaration is based on the procedure described in the international standard and directives as listed in the table below:

- IEC 62474 : 2018 (DIN EN IEC 62474 : 2019-09)
- (EG) Nr. 1907/2006 (REACH)
- Directive 2011/65/EU (RoHS)
- Resolution MEPC.269(68) "International Maritime Organization" (IMO); particularly "2015 Guidelines for the Development of the Inventory of the Hazardous Materials" (IHM)

16.1.1 Declarable substance groups

Component	Designation	Mass (g)	Declarable substance groups and substances (IEC 62474 database)	CAS No.	Mass %	Exemption (acc. to directive)
-	-	-	No SVHC present	-	-	-

16.1.2 RoHS directive 2011/65/EC

The devices meet the requirements of RoHS Directive 2011/65/EU dated 2013.01.03.

16.1.3 IMO Resolution MEPC.269(68)

The devices meet the requirements of the MEPC.269(68) Resolution of the "International Maritime Organization" (IMO), in particular the "2015 Guidelines for the Development of the Inventory of the Hazardous Materials" (IHM).

17 Control Drawing CEC / NEC

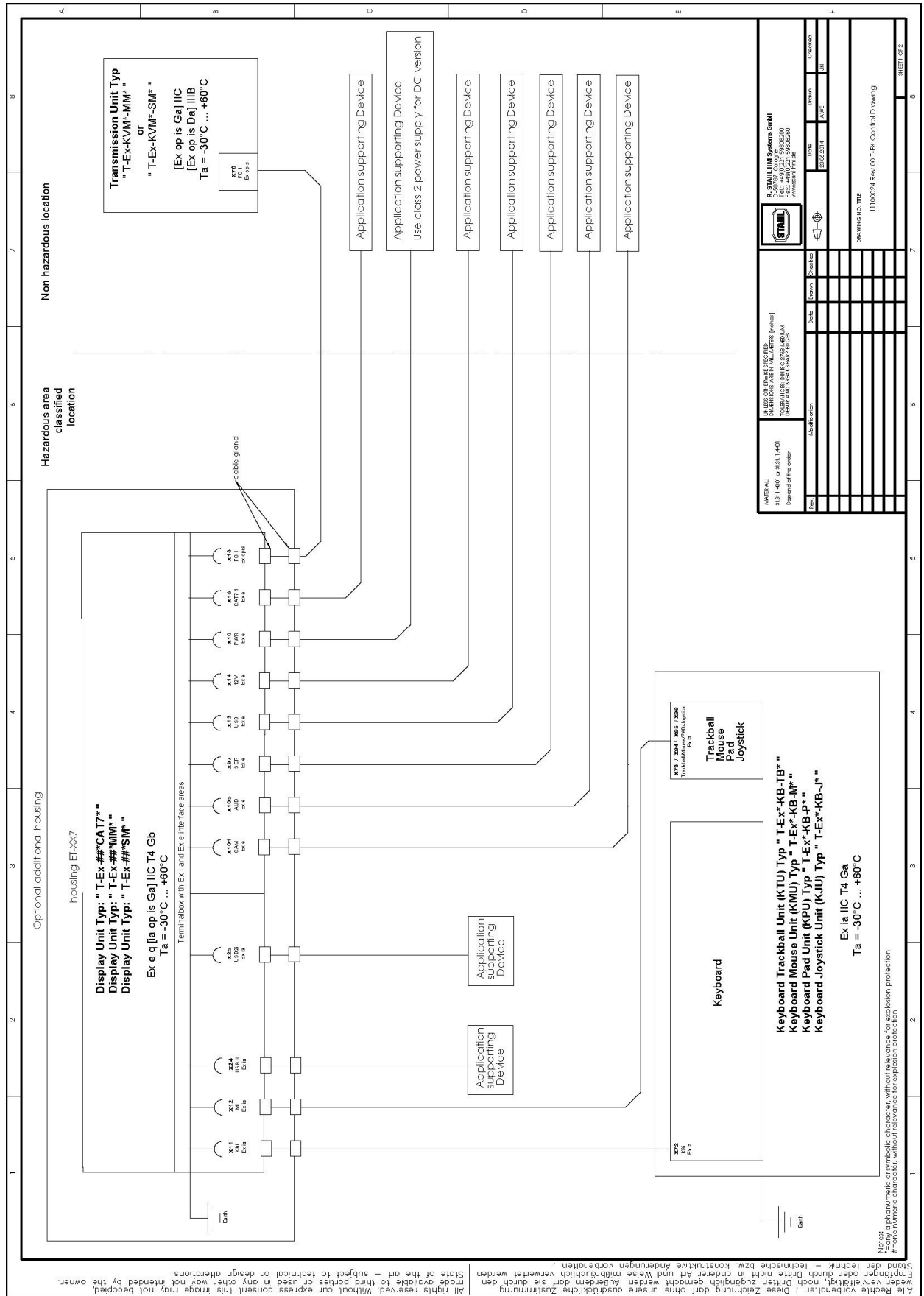

<h2 style="text-align: center;"><u>Security Advices</u></h2> <ol style="list-style-type: none"> 1. No revision to drawing prior to certification body. 2. The Associated Apparatus must be approved by a NRTL. 3. Manufacturer's installation drawing must be followed when installing associated apparatus. 4. Interconnection of equipment apparatus type of protection „I.S.“ with associated apparatus is allowed when the following is true: <div style="margin-left: 20px;"> <p>I.S. Equipment Associated Apparatus</p> <p>$V_{max} > U_0$</p> <p>$I_{max} > I_0$</p> <p>$P_i > P_0$</p> <p>$C_i + C_{cable} < C_0$</p> <p>$L_i + L_{cable} < L_0$</p> </div> 	<h2 style="text-align: center;"><u>Calculation of cable length</u></h2> <ol style="list-style-type: none"> 1.) Determination of maximum possible capacitance of cable: $C_{max} = C_0 - C_i$ (associated Apparatus) Determination of maximum possible inductance of cable: $L_{max} = L_0 - L_i$ (associated Apparatus) 2.) Determination of maximum possible cable length by capacitance and inductance of cable: $length\ C = C_{max}$ $C_{cable} (*1)$ $length\ L = L_{max}$ $L_{cable} (*1)$ 3.) Determination of maximum length of cable: length C or length L, whatever is less. (*1) when cable parameters are unknown, the following values may be used: $Cable = 60\ \mu F/ft.$ (200 pF/m) $L_{cable} = 0.2\ \mu H/ft.$ (0.66 $\mu H/m$) 	<p style="text-align: center;">All circuits must be wired as specified in the Canadian Electric Code for installation within Canada.</p>						
<p style="font-size: small; text-align: right;">Alle Rechte vorbehalten Diese Zeichnung darf ohne unsere ausdrückliche Zustimmung weder vervielfältigt, noch Dritten zugänglich gemacht werden. Außerdem darf sie durch den Empfänger oder durch Dritte nicht in anderer Art und Weise missbräuchlich verwendet werden. Stand der Technik - Technische bzw. konstruktive Änderungen vorbehalten.</p>								
<table border="1" style="width: 100%; border-collapse: collapse;"> <tr> <td style="width: 15%; font-size: x-small;"> MATERIAL: 100111000 (FIB. 1,40T) Requisition of the order </td> <td style="width: 45%; font-size: x-small;"> UNITS CONSUMER REFERRED: DIMENSIONS ARE IN MILLIMETERS (INCHES) TOLERANCES DIM. 0.20/0.10/0.05/0.025 TOLERANCES SURF. 0.05/0.10/0.15/0.20/0.25 </td> <td style="width: 40%; text-align: right;"> STAHL HMI Systems GmbH D-57471 Lennep Tel. +49(0)227 5980200 Fax. +49(0)227 5980201 www.stahl-hmi.de </td> </tr> <tr> <td style="font-size: x-small;"> Date: _____ Drawn: _____ Checked: _____ </td> <td style="font-size: x-small;"> Date: 23.02.2014 Drawn: JAVIE Checked: JH </td> <td style="font-size: x-small;"> DRAWING NO. TITLE 11100024 Rev.001 KEY Control Drawing </td> </tr> </table>			MATERIAL: 100111000 (FIB. 1,40T) Requisition of the order	UNITS CONSUMER REFERRED: DIMENSIONS ARE IN MILLIMETERS (INCHES) TOLERANCES DIM. 0.20/0.10/0.05/0.025 TOLERANCES SURF. 0.05/0.10/0.15/0.20/0.25	STAHL HMI Systems GmbH D-57471 Lennep Tel. +49(0)227 5980200 Fax. +49(0)227 5980201 www.stahl-hmi.de	Date: _____ Drawn: _____ Checked: _____	Date: 23.02.2014 Drawn: JAVIE Checked: JH	DRAWING NO. TITLE 11100024 Rev.001 KEY Control Drawing
MATERIAL: 100111000 (FIB. 1,40T) Requisition of the order	UNITS CONSUMER REFERRED: DIMENSIONS ARE IN MILLIMETERS (INCHES) TOLERANCES DIM. 0.20/0.10/0.05/0.025 TOLERANCES SURF. 0.05/0.10/0.15/0.20/0.25	STAHL HMI Systems GmbH D-57471 Lennep Tel. +49(0)227 5980200 Fax. +49(0)227 5980201 www.stahl-hmi.de						
Date: _____ Drawn: _____ Checked: _____	Date: 23.02.2014 Drawn: JAVIE Checked: JH	DRAWING NO. TITLE 11100024 Rev.001 KEY Control Drawing						

18 Declaration of EC conformity

18.1 EU

EU-Konformitätserklärung
EU Declaration of Conformity
Déclaration de Conformité UE



R. STAHL HMI Systems GmbH • Adolf-Grimme-Allee 8 • 50829 Köln, Germany

erklärt in alleiniger Verantwortung, *declares in its sole responsibility, déclare sous sa seule responsabilité,*

dass das Produkt:

that the product:

que le produit:

Bedien- und Beobachtungsgeräte

Operating and Monitoring Devices

Consoles de commande et de visualisation

Typ(en), *type(s), type(s):*

Display Unit T-EX-##-R2 or ET-##7*

Keyboard Trackb. Unit T-EX*-KB-TB* or KBDi-USB-TB50*

Keyboard Mouse Unit T-EX*-KB-M* or KBDi-USB-M*

Keyboard Pad Unit T-EX*-KB-P* or KBDi-USB-P*

Keyboard Joystick Unit T-EX*-KB-J* or KBDi-USB-J*

Transmission Unit T-EX-KVM*-* or KVM*-*

*=any alphanumeric or symbolic character, without relevance for explosion protection

#=one numeric character, without relevance for explosion protection

mit den Anforderungen der folgenden Richtlinien und Normen übereinstimmt.

is in conformity with the requirements of the following directives and standards.

est conforme aux exigences des directives et des normes suivantes.

Richtlinie(n) / Directive(s) / Directive(s)	Norm(en) / Standard(s) / Norme(s)
2014/34/EU 2014/34/EU 2014/34/UE	ATEX-Richtlinie ATEX Directive Directive ATEX
	EN 60079-0:2009 EN 60079-5:2007 EN 60079-7:2007 EN 60079-11:2007 EN 60079-26:2007 EN 60079-28:2004 EN 60079-31:2009 EN 61241-11:2006
	Das Produkt entspricht Anforderungen aus: Product corresponds to requirements from: Produit correspond aux exigences: EN 60079-0:2012/A1:2013 EN IEC 60079-0:2018 EN 60079-5:2015 EN 60079-7:2015 EN IEC 60079-7:2015 + A1:2018 EN 60079-11:2012 EN 60079-26:2015 EN 60079-28:2015 EN 60079-31:2014

Kennzeichnung, *marking, marquage:*

Display Unit T-EX-##-R2 or ET-##7*:

II 2(1) G Ex eb q [ia op is Ga] IIC T4 Gb

II 2(1) D Ex tb IIIC [ja op is Da] T110°C Db

Keyboard Trackb. Unit T-EX*-KB-TB* or KBDi-USB-TB50*, Keyboard Mouse Unit T-EX*-KB-M* or KBDi-USB-M*, Keyboard Pad Unit T-EX*-KB-P* or KBDi-USB-P*, Keyboard Joystick Unit T-EX*-KB-J* or KBDi-USB-J*:

II 2 G Ex ia IIC T4 Gb

II 2 D Ex ia IIIB T110°C Db

Transmission Unit T-EX-KVM*-* or KVM*-*:

II (1) G [Ex op is Ga] IIC

II (1) D [Ex op is Da] IIIB



CE 0158

EU-Baumusterprüfbescheinigung:

EU Type Examination Certificate:

Attestation d'examen UE de type:

BVS 11 ATEX E 102 X

(DEKRA EXAM GmbH,

Dinnendahlstraße 9, 44809 Bochum, Germany, NB0158)

Produktnormen nach Niederspannungsrichtlinie:
Product standards according to Low Voltage Directive:
Normes des produit pour la Directive Basse Tension:

EN 61010-1:2001 + Corrigendum / Errata

DIN EN 62368-1:2016, IEC 62368-1:2014 (Second Edition)

EU-Konformitätserklärung
EU Declaration of Conformity
Déclaration de Conformité UE



2014/30/EU 2014/30/EU 2014/30/UE	EMV-Richtlinie EMC Directive Directive CEM	EN 61000-6-2:2005 EN 61000-6-4:2007 + A1:2011
2011/65/EU 2011/65/EU 2011/65/UE	RoHS-Richtlinie: RoHS Directive: Directive RoHS:	EN IEC 63000:2018

Für spezifische Merkmale und Bedingungen siehe Betriebsanleitung.
For specific characteristics and conditions see operating instructions.
Pour les caractéristiques et conditions spécifiques, voir le mode d'emploi.

Köln, 2020-12-10

i.V.

Jordan Düren

i.V.

A. Jung

Ort und Datum
Place and date
Lieu et date

J. Düren
 Technical Director

A. Jung
 Ex Representative

18.2 RCM

Supplier's declaration of conformity



As required by the following Notices:

- > *Radiocommunications (Compliance Labelling - Devices) Notice 2014* made under section 182 of the *Radiocommunications Act 1992*;
- > *Radiocommunications Labelling (Electromagnetic Compatibility) Notice 2017* made under section 182 of the *Radiocommunications Act 1992*
- > *Radiocommunications (Compliance Labelling – Electromagnetic Radiation) Notice 2014* made under section 182 of the *Radiocommunications Act 1992* and
- > *Telecommunications (Labelling Notice for Customer Equipment and Customer Cabling) Instrument 2015* made under section 407 of the *Telecommunications Act 1997*.

Instructions for completion

- > *Do not return this form to the ACMA.* This completed form must be retained by the supplier as part of the documentation required for the compliance records and must be made available for inspection by the ACMA when requested.

Supplier's details (manufacturer, importer or authorised agent)

Company Name (OR INDIVIDUAL)

R. STAHL Australia Pty Ltd
TRADING AS R. STAHL HMI Systems GmbH

ACN/ARBN

ABN 81150955838

OR

New Zealand IRDN

--

Street Address (AUSTRALIAN or NEW ZEALAND)

848 Old Princes Highway
Sutherland, NSW
POSTCODE 2232
Phone: +61 2 4254 4777

Product details and date of manufacture

Product description – brand name, type, current model, lot, batch or serial number (if available), software/firmware version (if applicable)

<p>Operating and Monitoring Devices</p> <p>Display Unit T-EX-##*-CAT7*; Display Unit T-EX-##*-MM*; Display Unit T-EX-##*-SM*; * =any alphanumeric or symbolic character; # =one numeric character</p>
<p>Operating and Monitoring Devices</p> <p>Display Unit MT-##7*-CAT7*; Display Unit MT-##7*-MM*; Display Unit MT-##7*-SM*; * =any alphanumeric or symbolic character; # =one numeric character</p>
<p>Keyboard</p> <p>Keyboard Trackball Unit T-EX*-KB-TB*; Keyboard Mouse Unit T-EX*-KB-M*; Keyboard Pad Unit T-EX*-KB-P*; Keyboard Joystick Unit T-EX*-KB-J*; * =any alphanumeric or symbolic character</p>
<p>Transmission Unit</p> <p>Transmission Unit T-EX-KVM*-CAT7*; Transmission Unit T-EX-KVM*-MM*; Transmission Unit T-EX-KVM*-SM*; * =any alphanumeric or</p>

symbolic character

Compliance – applicable standards and other supporting documents

Evidence of compliance with applicable standards may be demonstrated by test reports, endorsed/accredited test reports, certification/competent body statements.

Having had regard to these documents, I am satisfied the above mentioned product complies with the requirements of the relevant ACMA Standards made under the *Radiocommunications Act 1992* and the *Telecommunications Act 1997*.

List the details of the documents the above statement was made, including the standard title, number and, if applicable, number of the test report/endorsed test report or certification/competent body statement

EN 61000-6-4:2007; EN 61000-6-4:2007 + A1:2011

Declaration

I hereby declare that:

1. I am authorised to make this declaration on behalf of the Company mentioned above,
2. the contents of this form are true and correct, and
3. the product mentioned above complies with the applicable above mentioned standards and all products supplied under this declaration will be identical to the product identified above.

Note: Under section 137.1 of the *Criminal Code Act 1995*, it is an offence to knowingly provide false or misleading information to a Commonwealth entity.
Penalty: 12 months imprisonment

	Managing Director
SIGNATURE OF SUPPLIER OR AGENT	POSITION IN ORGANISATION
John Zagame	2018-10-15
PRINT NAME	DATE

The *Privacy Act 1988* (Cth) (the Privacy Act) imposes obligations on the ACMA in relation to the collection, security, quality, access, use and disclosure of personal information. These obligations are detailed in the Australian Privacy Principles.

The ACMA may only collect personal information if it is reasonably necessary for, or directly related to, one or more of the ACMA's functions or activities.

The purpose of collecting the personal information in this form is to ensure the supplier is identified in the 'Declaration of conformity'. If this Declaration of Conformity is not completed and the requested information is not provided, a compliance label cannot be applied.

Further information on the Privacy Act and the ACMA's Privacy Policy is available at www.acma.gov.au/privacypolicy. The Privacy Policy contains details about how you may access personal information about you that is held by the ACMA, and seek the correction of such information. It also explains how you may complain about a breach of the Privacy Act and how we will deal with such a complaint.

Should you have any questions in this regard, please contact the ACMA's privacy contact officer on telephone on 1800 226 667 or by email at privacy@acma.gov.au.

19 Release notes

This chapter lists the changes made in the most recent versions of these Operating Instructions.

Version 01.00.06

- Changes to cover layout
- Changes to publisher's note, new e-mail addresses
- Addition of "ET-/MT-6x8-DVI3 devices in "device allocation" table
- Addition of text for "SERIES 600" and "ET-/MT-xx8 for note on documentation regarding "device allocation"
- Inclusion of chapter "Conformity to Standards"
- Change of chapter "Certificates", now listed in table
- Change of notes on "Certificates"
- Removal of "X" from EAC certificate
- Deletion of "Digits of serial number identify year of manufacture" in "General safety information"
- Change of chapter "Connection diagrams", images and text, for all listed devices
- Restructuring and change of chapters "Disposal" and "Material declaration"
- Inclusion of control drawing
- Renewal of Declaration of EC conformity
- Inclusion of Declaration of EAC conformity
- Change to address field on back
- Addition of CNEx certificate
- Formal changes

Version 01.00.07

- Deletion of old release notes
- Addition of column "valid until" in the certificate table
- Addition of values in the "valid until" column
- Correction of list CE / ATEX in section "Certificates DVI1 and DVI3"
- Deletion of EAC certificate
- Deletion of EAC Ex marking
- Deletion of Declaration of EAC conformity
- Correction of name of Korean certificate from KGS to KCS
- Change of DNV / GL to DNV
- Addition of note on "Customer confirmation letter" in section "Certificates DVI1 and DVI3"
- Renewal of IECEx link
- Addition of "with or without writing" to "Notes" and "Dokumentation" in section "Formatting conventions"
- Addition of note on "FO interfaces" in "Technical Data"
- Addition of note on "FO interfaces" in "Connections"
- Update of section "Industrial Security"
- Addition of chapter "Assembly KVM-DVI3"
- Change: order versions KVM-DVI1 and KVM-DVI2 set to "no longer available" in section "Type code"
- Addition of chapter "Symbols used in these Operating Instructions"
- Inclusion of field function "TC" in "Certificates"
- Correction of telephone and fax numbers
- Formal changes

R. STAHL HMI Systems GmbH
Adolf-Grimme-Allee 8
D 50829 Cologne

T:	(Sales Support)	+49 221 768 06 - 1200
	(Technical Support)	+49 221 768 06 - 5000
F:		+49 221 768 06 - 4200
E:	(Sales Support)	sales.dehm@r-stahl.com
	(Technical Support)	support.dehm@r-stahl.com

r-stahl.com



THE STRONGEST LINK.