



Operating Instructions



Device platform EAGLE

ET-xx6-A

SERIES 300 Operator Interfaces

SERIES 400 Panel PC

SERIES 500 Thin Clients



THE STRONGEST LINK.

HW-Rev. ET-xx6-A-FX:	03.00.13
HW-Rev. ET-xx6-A-TX:	03.00.23
HW-Rev. ET-xx6-A-FX-BT:	03.00.18
HW-Rev. ET-xx6-A-TX-BT:	03.00.28

Operating Instructions version:	03.00.41
Issue date:	29.08.2024

Order number:	297546
---------------	--------

Disclaimer

Publisher and copyright holder:

R. STAHL HMI Systems GmbH
Adolf-Grimme-Allee 8
D 50829 Köln

Telephone:	(Sales Support)	+49 221 768 06	- 1200
	(Technical Support)		- 5000
Fax:			- 4200
E-mail:	(Sales Support)	sales.dehm@r-stahl.com	
	(Technical Support)	support.dehm@r-stahl.com	

- All rights reserved.
- This document may not be reproduced in whole or in part except with the written consent of the publisher.
- This document may be subject to change without notice.

Any warranty claims are limited to the right to demand amendments. Liability for any damage that might result from the content of this description or all other documentation is limited to clear cases of premeditation.

We reserve the right to change our products and their specifications at any time, provided it is in the interest of technical progress. The information in the current manual (in the internet and on CD / DVD / USB stick) or in the operating instructions included with the HMI device applies.

Trademarks

The terms and names used in this document are registered trademarks and / or products of the companies in question.

Copyright © 2024 R. STAHL HMI Systems GmbH. Subject to alterations.

Specific markings

The markings in these operating instructions refer to specific features that must be noted.

In detail, these are:

 DANGER	This sign alerts users to hazards that will result in death or serious injury if ignored !
---	---

 WARNING	This sign alerts users to hazards that may result in death or serious injury if ignored !
--	--

 CAUTION	This sign alerts users to hazards that may damage machinery or equipment or result in injury if ignored !
--	---

 ATTENTION	Information highlighted by this symbol indicates measures for the prevention of damage to machinery or equipment !
--	--

 NOTICE	Information highlighted by this symbol (with and without lettering) indicates important information of which particular note should be taken !
---	--

 DOCUMENTATION	Information highlighted by this symbol (with and without lettering) refers to a different chapter or section in this manual or other documentation or a web-page !
--	--

Warnings

	Caution ! In ambient temperatures exceeding +45 °C the surface of the devices may heat up. Caution when touching !
---	--

	Caution ! The laser diodes installed in our Exicom operator devices, media converters and switches emit invisible laser radiation: 100Base-FX - 1300 nm FO-MM / 1000Base-SX - 770 ... 860 nm FO-SM / 1000Base-LX - 1270 ... 1355 nm Acc. to EN 60825-1 the laser diode is classified as a class 1M laser / Do not view directly with optical instruments. The viewing of the laser beam through certain optical instruments (e.g. magnifying glasses, telescopes and microscopes) from a distance of less than 100 mm may damage eyesight. (beam output at the emitting diode (TD-A, TD-B) or the fibre optic end).
---	---

Table of contents

	Description	Page
	Disclaimer	2
	Specific markings	3
	Warnings	3
	Table of contents	4
1	Preface	7
2	Device function	7
2.1	Image sticking	7
2.2	Processor types	7
2.3	Activation pressure touchscreen	7
2.4	ET-3x6-A-* (SERIES 300 Operator Interfaces)	8
2.5	ET-4x6-A-* (SERIES 400 Panel PC)	8
2.6	ET-5x6-A-* (SERIES 500 Thin Clients)	8
2.7	Overview hardware revision ET-xx6	9
3	Technical Data	10
3.1	Additionally for ET-3x6-A-* (Operator Interfaces)	13
3.1.1	All devices up to hardware revision 03.00.x2	13
3.1.2	All devices starting from hardware revision 03.00.x5	13
3.1.3	All devices starting from hardware revision 03.00.x7	13
3.1.4	All devices starting from hardware revision 03.00.x8	13
3.2	Additionally for ET-4x6-A-* (Panel PC)	14
3.2.1	All devices up to hardware revision 03.00.x2	14
3.2.2	All devices starting from hardware revision 03.00.x4	14
3.2.3	All devices starting from hardware revision 03.00.x6	14
3.3	Additionally for ET-5x6-A-* (Thin Clients)	14
3.3.1	All devices up to hardware revision 03.00.x2	14
3.3.2	All devices starting from hardware revision 03.00.x4	14
3.3.3	All devices starting from hardware revision 03.00.x6	14
4	Conformity to standards	15
5	Certificates	16
	Europe (CE / ATEX)	16
	Global (IECEX)	16
	USA (NEC)	16
	Canada (CE-Code)	16
	India (BIS / PESO / CCE)	16
	Brazil (INMETRO)	16
	China (CCC)	16
	Korea (KCC / KCS)	16
	Australia (RCM)	16
	Marine / ship certification (ABS)	16
	Marine / ship certification (DNV)	16
	Marine / ship certification (LR)	16
6	Marking	17
7	Power supply	18
7.1	HMI devices	18

7.1.1	HMI device terminals	18
7.1.1.1	Tightening torque	18
8	Permitted maximum values	19
8.1	External, non-intrinsically safe circuits	19
8.2	External inherently safe optical interface	19
8.3	External intrinsically safe circuits	20
9	Type code	23
9.1	Certificate	23
9.2	Variants	23
9.2.1	ET-3x6-A-*-BS (Operator Interfaces)	23
9.2.2	ET-3x6-A-*-BT (Operator Interfaces)	24
9.2.3	ET-4x6-A-*-BT (Panel PC)	25
9.2.4	ET-5x6-A-*-BT (Thin Client)	26
10	Safety Advice	27
10.1	Installation and operation	27
10.2	Cautionary notes	28
10.3	Special conditions	28
11	Installation	29
11.1	General information	29
11.2	ET-xx6-A-*	29
11.2.1	HMI device Installation in housings type of protection "e" or "t"	30
11.2.2	Cable glands	30
11.3	Usage of the USB-interfaces	31
11.3.1	Usage of USB Memory-Sticks	31
11.3.2	Usage of external USB devices	31
11.4	USB interfaces	32
11.4.1	I.S. USB interfaces USB0, USB2	32
11.4.2	Ex e USB interfaces USB1, USB3	32
11.4.2.1	Connection variations for Ex e USB interfaces	32
11.4.2.2	Connection terminal with protection type "e" (IEC/EN 60079-7)	33
12	Assembly and disassembly	34
12.1	General information	34
12.2	Cut-out ET-xx6-A-*	34
12.3	Assembly free area	35
13	Operation	36
13.1	General information	36
13.2	Connections	36
13.2.1	Dip switch settings S3 and S4	38
13.2.2	Status LEDs	38
13.2.2.1	LEDs	38
13.3	Connection of Readers	40
13.3.1	Type RSi1 connection version 1	40
13.3.2	Type RSi1 connection version 2	40
14	Maintenance, service	41
14.1	Damaged sealing	41
14.2	Servicing	41
14.3	Saving data with ET-3x6-A-*	41

14.4	Time function	42
15	Troubleshooting	42
16	Disposal / Restricted substances	42
16.1	Declaration of substances and restricted substances	42
16.1.1	Declarable substance groups	43
16.1.2	RoHS directive 2011/65/EC	43
16.1.3	IMO Resolution MEPC.269(68)	43
16.1.4	China RoHS labelling	43
17	General information	44
17.1	Touch driver	44
17.2	Keyboard features	44
17.3	ET-4x6-A-* (Panel PC)	45
17.3.1	Up to Windows 7 operating systems	45
17.3.1.1	Licensing issues	45
17.3.1.2	Note on Windows Embedded operating systems	45
17.3.2	Windows® 10 IoT Enterprise 2019 LTSC operating system	45
17.3.2.1	Recovery	46
17.3.2.2	Company-specific Windows installations	46
17.3.3	Initial start-up	46
17.3.4	Recovery Stick	46
17.3.5	Back-up	46
17.3.6	Switching off / closing down	47
17.3.7	Data loss	47
17.4	Defective pixels	48
17.4.1	Terminology	48
17.4.2	Display specification	49
18	Optical acceptance of surfaces	50
18.1	Optical acceptance glass	50
18.3	Optical acceptance, other surfaces	51
19	Certification Drawing NEC	53
20	Control Drawing	54
20.1	NEC	54
20.2	CE-Code	57
21	Installation Instructions Requirements China	60
22	Declarations of conformity	61
22.1	EU	61
22.2	CCC	63
22.2.1	English version	63
22.2.2	Chinese version	71
22.3	RCM	79
23	Release notes	81

1 Preface

These Operating Instructions contain all aspects relevant to explosion protection for the ET-xx6-A-* HMI devices (SERIES 300 Operator Interfaces – EAGLE, SERIES 400 Open HMI – Panel PC's and SERIES 500 Thin Clients). They also contain information on the connection and installation of these devices.

These Operating Instructions contain a joint description of all three product lines: Operator Interfaces, Panel PC's and Thin Clients. Any differences between the three product lines will be explicitly mentioned and dealt with. As a rule, though, the information contained in these Operating Instructions applies to all models of the ET-xx6-A-* series.

The ET-xx6-A-* HMI devices with display sizes of 26 cm / 10.4", 38 cm / 15" and 48 cm / 19" will be available in Hardware Revision 3.

 NOTICE	All data relevant to explosion protection from the EC-type examination certificate were copied into these operating instructions.
	For the correct operation of all associated components please note, in addition to these operating instructions, all other operating instructions enclosed in this delivery as well as the operating instructions of the additional equipment to be connected !

 DOCUMENTATION	Please note that all certificates of the HMI devices can be found in a separate document (CE_ET-xx6-A).
	You can find this document in the internet at r-stahl.com or request it from R. STAHL HMI Systems GmbH.

2 Device function

The ET-xx6-A-* HMI devices are explosion-proof equipment for installation in hazardous areas and can be installed in zones 1, 2, 21 and 22 according to ATEX directive.

All devices have a modular structure, which makes changes and maintenance easy. They can be integrated into control cabinets or panels, etc.

2.1 Image sticking

Continuous displaying fixed pattern may include image sticking. It's recommended to use screen saver or moving content periodically if fixed pattern is displayed on the screen.

2.2 Processor types

All devices are fitted with modern, powerful processors. Depending on the type of application, different processor types are used for the HMI devices (see Technical Data).

Starting in 2016, a new Intel® Atom™ processor type of the Bay Trail (BT / BS) platform will gradually replace all previous processor types in the HMI devices. This new processor type processes data four times as fast as the previous processors.

2.3 Activation pressure touchscreen

To prevent damage to the touchscreen, activation pressure on the screen must be very low (0.1 to max. 1 N).

2.4 ET-3x6-A-* (SERIES 300 Operator Interfaces)

The ET-3x6-A-* operator interfaces have been designed for the Visualization of medium-sized automation tasks, operation as built-in device and tankfarm application in hazardous areas. The ET-3x6-A-* operating stations have been designed to run with a proprietary operating system, making them highly secure against external manipulation.

Users operate the device via the membrane keyboard integrated into the front plate and via the LCD display with touch screen.

Communication with control and automation systems runs via the serial interfaces (RS-232 RS-422/485, Ethernet) connected in the "e"-area at the back of the devices. Various peripheral devices, such as barcode scanners, card readers, USB sticks and WLAN / Bluetooth modules can be connected via USB interfaces or optional fitted modules.

With a wealth of functions, these HMI devices provide optimum visualization. Their active communication concept in combination with integrated functionality reduce the automation system workload.

2.5 ET-4x6-A-* (SERIES 400 Panel PC)

The ET-4x6-A-* devices are robust Panel PC's for hazardous areas. With their pre-installed Windows operating system they are ready to run straight away.

As a standard, all Panel PC's are equipped with a touch screen and several interfaces and are based on the powerful Atom technology, making them the most powerful devices on the market.

2.6 ET-5x6-A-* (SERIES 500 Thin Clients)

The ET-5x6-A-* devices of the 500 SERIES can be integrated into modern networks as Thin Clients or with a KVM box via KVM-over-IP, thus providing ideal and flexible access options with central data administration.

The ET-5x6-A-* device, which is used for operation and visualization, is located in the hazardous area, whereas the PC that is operated is located in the safe area. Each ERP / MES network can be accessed from each Thin Client via the IP address.

The Thin Client system supports both modern technologies such as DVI and USB and older technologies such as VGA and PS/2.

2.7 Overview hardware revision ET-xx6

HW-Rev.	Device type	Technical changing	Changing date hardware	OI version	OI date
03.00.1x	ET-xx6-A-FX	Approval Rev. 3, FX interface	25.05.2011	03.00.02	09.06.2011
03.00.2x	ET-xx6-A-TX	Approval Rev. 3, TX interface			
03.00.x2	ET-xx6-A-*	5-wire touch	23.06.2014	03.00.15	03.09.2014
03.00.x3	ET-xx6-A-*	Internal changes	29.09.2014	-	-
03.00.x4	ET-xx6-A-*	Bay Trail processor, quad core	10.02.2016	03.00.17	04.01.2016
03.00.x5	ET-3x6-A-*.BS-*	Bay Trail processor, single core	08.05.2017	03.00.25	03.06.2017
03.00.x6	ET-xx6-A-*	M.2 memory	14.06.2018	03.00.29	14.07.2018
03.00.x7	ET-3x6-A-*.BS-*				
03.00.x8	ET-xx6-A-*	BIOS Update BIOS-V1.63r4 no C6	29.06.2021	03.00.37	13.10.2021
03.00.x9	ET-3x6-A-*.BS-*				
03.00.x8	ET-xx6-A-*	SERIES 300 released with Bay Trail quad core prozessor from 01/2024	31.05.2021	03.00.40	12.01.2024
03.02.xx	ET-xx6-A-*.RS2	Approval 2nd supplement with COM2 (X22)	21.11.2012	03.02.00	16.04.2013

3 Technical Data

Function / Equipment	ET-306-A- ET-406-A-*	ET-316-A- ET-416-A- ET-516-A-*	ET-336-A- ET-436-A-*(SR) ET-536-A-*(SR)	ET-456-A- ET-556-A-*
Display type	TFT Color, 16,777,216 Colors			
Display size	26 cm (10.4")		38 cm (15")	48 cm (19")
Resolution in pixels	ET-306-A- VGA 640 x 480 ET-406-A- SVGA 800 x 600	SVGA 800 x 600	XGA 1024 x 768	SXGA 1280 x 1024
Display	Touchscreen on glass			
Touchscreen * Type TFT Type SR (Sunlight readable)	5-wire analogue resistive		5-wire analogue resistive	-
* Comment	Under extreme environmental conditions (high humidity, temperature), bubbles can form on the touch surface in rare cases. This does not represent any functional restriction and affects only the appearance.			
Backlight	LED background lighting			
Service life of backlight at +25 °C [+77 °F] +55 °C [+131 °F]	70,000 h 35,000 h			
Brightness Type TFT Type SR (Sunlight readable)	VGA 450 cd/m ² SVGA 400 cd/m ² -		350 cd/m ² 1000 cd/m ²	350 cd/m ² -
Contrast Type TFT Type SR (Sunlight readable)	700:1		600:1	1000:1 -
Touchscreen activation	Low activation pressure (0.1 up to max. 1 N)			
Touchscreen input method	Finger, gloved finger or stylus			
Touchscreen durability	Polyester foil is easily scratched, with high pressure force the spacer dots could be damaged.			
Touchscreen scratch hardness MoHS	-			
Touchscreen scratch hardness pencil hardness test ISO 15184	3H			
Touchscreen transmissivity / optics	Small milky effect due to the foil			
Touchscreen surface contaminants	Unaffected			
Touchscreen abrasive resistance	36 million times with a silicone rubber of R8 finger, hitting rate 250 g at 2 times per second			
Keyboard	Polyester membrane on aluminium plate (> 1 million actions)			
Functional keys	12	12	8	8
Soft keys	10	no	no	no
Cursor keys	yes	no	no	no
Alphanumeric keys	12	no	no	no
System keys	14	no	no	no
Additional keyboard	Optional 100 mA max. power consumption 105 Keys or 107 keys with integrated trackball / joystick (variant with trackball / joystick not for ET-3x6-A-*)			
Trackball / joystick	Optional for ET-4x6-A-* and ET-5x6-A-*			
Power supply	Directly in the integrated Ex e connection box			
Rated operational voltage DC	24 V			
Voltage range DC	20.4 – 28.8 V			
up from 100 GB data memory	21.6 – 28.8 V			
Current consumption DC	1.2 A			
Connections	via screw terminals, 2.5 mm ² (AWG14) green (Ex e) (connection X1)			
Max. operating voltage U _m	30 VDC			

Function / Equipment	ET-306-A* ET-406-A*	ET-316-A* ET-416-A* ET-516-A*	ET-336-A* ET-436-A*-(SR) ET-536-A*-(SR)	ET-456-A* ET-556-A*
Real-time clock Data buffer Battery Capacitor	yes Lithium battery and capacitor buffered, maintenance-free > 5 years at least 4 days			
Status display LEDs Below the back cover	for activity on - Solid state flash drive or HD - Ethernet link - COM 1 and COM 2			
Interfaces	Description			
Ethernet	Either TX or FX			
Copper (TX)	10/100Base-TX, 10/100 Mbit (Ex e) (connection X11)			
Optical fibre (FX)	100Base-FX, 100 Mbit, inherently safe (Ex op is) (connection X10)			
USB	2x Ex e (connection X5 and X7) / 2x Ex ib (connection X4 and X6) / USB 2.0, 480 Mbit/s			
Note on USB interfaces	The USB interfaces are based on USB 2.0. Due to explosion protection rules, the USB interface properties (such as speed or power supply) may be restricted.			
PS/2 (Ex ia)	For external keyboard, mouse*, trackball*, joystick* (connection X9) * not available for ET-3x6-A*			
Serial COM1	RS-232 / RS-422 / RS-485 (Ex e) (connection X2)			
Readers COM2	Barcode scanner, Proximity reader interface (Ex ib) (connection X8)			
Audio	Line out output (Ex e) (connection X3)			
Fieldbus	not for Thin Client			
Operator Interface	MPI with MPI Box SSW7-RK512-RS-422			
Panel PC	MPI with MPI Box SSW7-HMI-RS-422			
	Design			
Ethernet copper (TX)	Screw terminals, 2.5 mm ² (AWG14) green			
USB (Ex e)				
PS/2 (Ex ia)				
Serial COM1				
Readers COM2				
Audio				
USB (Ex ib)	1x USB female connector type A / 1x screw terminals, 2.5 mm ² (AWG14) green			
Ethernet optical fibre (FX)	SC duplex female connector			
Data cable / -length				
Copper (TX)	up to 100 m (330 ft) via CAT5 installation cable AWG22			
Optical fibre (FX)	up to 2000 m (6562 ft) via 62.5 / 125 µm (core- / external cross section) multi-mode optical fibre cable			

 When using the fibre optic interfaces of EAGLE devices, they must be connected and safely operated with other devices that comply with the limit values of Class 1 according to IEC 60825-1 or are classified as inherently safe optical radiation "op is" according to IEC 60079-28.

Front plate	Polyester on seawater-proof aluminium with touch technology and safety glass (standard) or Stainless steel on seawater-proof aluminium with touch-technology and safety glass, F-keys polyester			
	-	-	yes (not ET-336-A*)	yes

Function / Equipment	ET-306-A* ET-406-A*	ET-316-A* ET-416-A* ET-516-A*	ET-336-A* ET-436-A*-(SR) ET-536-A*-(SR)	ET-456-A* ET-556-A*
Housing	Stainless steel			
Housing protection type	IP66			
HMI Types	PM = PanelMount = panel mount device OS = Operator Station			
HMI Types comment	Panel mount device (PM): devices without additional enclosure (HSG) and without additional accessories Operator Station (OS): devices mounted inside additional enclosure (HSG)			
Cable glands				
Type *	8161 (Ex e)		HSK-M-Ex (Ex e)	
Number	6 x M16		3 x M20	
Thread size	M16 x 1.5 and M20 x 1.5			
Cable diameter range	M16 = 5 ... 9 mm		M20 = 6 ... 12 mm	
Width across flats	M16 = SW20		M20 = SW22	
* Comment	Similar certified cable glands may be used.			
* Comment a	Not used cable glands must be closed by certified screw plugs or stopping plugs !			
Breathing gland	The breathing gland is part of the enclosure and is included in the device certification.			
Operating temperature range				
Operation	-20 °C ... +55 °C * / [-4 °F ... +131 °F] *			
Operation with heater **	-30 °C ... +55 °C * / [-22 °F ... +131 °F] *			
Storage temperature range	-30 °C ... +60 °C / [-22 °F ... +140 °F]			
* Comment	for ET-4x6-A* and ET-5x6-A*: Operation at +55 °C / [+131 °F] for a maximum of 5 hours, at +50 °C / [+122 °F] for continuous operation (24/7)			
** Comment	The heater used must be of such a design that the temperature inside the HMI device's housing does not fall below -20 °C / [-4 °F] (-30 °C / [-22 °F] only at the front) ! Operators must ensure that the components integrated in the enclosure are only be operated when the temperatures inside the enclosure are within the permitted (certified) temperature range for these components. Further measures may be necessary.			
Heat dissipation	approx. 50 % via front plate, approx. 50 % via housing			
HMI Types comment OS	If the HMI device is installed in an additional enclosure (HSG), the upper temperature limit is reduced by 5 °C / [41 °F], due to the device's own heating and lower temperature dissipation in the additional enclosure ! Thus, the operator stations offers "only" an operation temperature range of -20 °C ... +50 °C / [-4 °F ... +122 °F] !			
Environmental conditions	valid for all devices			
	Level	Test specification		
Relative humidity	90 % at +40 °C [+104 °F], without condensation	-		
Damp heat	+55 °C [+131 °F] / 95 %	IEC 60068-2-30 : 2005		
	+55 °C [+131 °F] (±2 °C [+35.6 °F]) ≥95 %	DNV		
(cyclic 2x 24 h)	+55 °C [+131 °F] / 90-100 % +20 °C [+68 °F] / 80-100 %	LR Type Approval TA 02 (2002)		
Corrosion resistant	ISA-S71.04-1985, severity level G3	EN 60068-2-60		
Vibration				
Vibration (sinus)	5 up to 13.2 Hz: ±1 mm 13,2 up to 100 Hz: ±0.7 g axis X, Y, Z	IEC 60068-2-6 : 2008 and DNV Certification No. 2.4 (2006)		
	10 Hz, 1 g 450 Hz, 1 g Sweep cycle 1 oct/min Operating mode 1.2 Axis X, Y, Z	IEC 60068-2-6 : 2008		
Vibration / broadband random	10 Hz, 0,0100 PSD[(m/s²)²/Hz] 450 Hz, 0,0100 PSD[(m/s²)²/Hz] G _{rms} 2.11 Axis X, Y, Z	IEC 60068-2-64 : 2009		
Shock	20 impacts 20 g/11 ms	IEC 60068-2-27 : 1995		
Location classes	according to DNV guideline CG-0339			
	Temperature	A		
	Humidity	B		
	Vibration	A		
	EMC	B		
Enclosure	B			

Electromagnetic compatibility				
Immunity	According to IEC 61000-6-2 (01/2005) and DIN EN 61323-1 (10/2006) for industrial areas			
Emission	According to IEC 61000-6-4 (02/2011), DIN EN 55011 / CISPR 11 (03/2008) for industrial environments and DIN EN 55022 / CISPR 22 (05/2008) for Class A			
Positive pressure operation	< = 20 mbar (not SR devices)			
Dimensions [mm] / [ft]				
Front (w x h)	400 x 270 / [1.31] x [0.89]	372 x 270 / [1.22] x [0.89]	440 x 340 / [1.44] x [1.12]	535 x 425 / [1.76] x [1.39]
Cut-out w x h (+/- 0.5) / [0.0016]	385.5 x 257.5 / [1.26] x [0.84]	359.5 x 257.5 / [1.18] x [0.84]	427.5 x 327.5 / [1.40] x [1.07]	522.5 x 412.5 / [1.71] x [1.35]
Depth of cut-out	150 / [0.49]		165 / [0.54]	
Wall thickness	≤ 8 / [0.0087]			
Mounting position	Vertical or horizontal			
Weight [kg] / [lbs]				
Device	13.00 / [28.66]	12.60 / [27.78]	17.30 / [38.14]	23.50 / [51.81]
Fixing frame	0.6 / [1.32]	0.6 / [1.32]	0.7 / [1.54]	0.9 / [1.98]

 The ET-xx6-A-* devices from the EAGLE device platform are tested for installation in enclosures with type of protection Ex p with a maximum pressure of 20 mbar.

3.1 Additionally for ET-3x6-A-* (Operator Interfaces)

3.1.1 All devices up to hardware revision 03.00.x2

Processor	AMD Geode LX 800; 266 MHz
RAM	512 MB
Data memory	1 GB
Operating system	RT Target
Image	SPSPlus Runtime
Languages	Global, multilingual language support
Number of protocol drivers	a maximum of 4 simultaneously
Number of process images	> 1000 dynamic
Number of texts / messages	Dynamically limited by main memory
Number of variables per page	255
Number of messages	4096 fault messages, 4096 operation messages
Font sets	4 independent Windows uncondensed fonts
Configuration memory type	Flash memory

3.1.2 All devices starting from hardware revision 03.00.x5

Processor	Intel Bay Trail (BS) Atom E3815 Single Core; 1.46 GHz
RAM	2 GB
Data memory	16 GB
Type of data memory	Flash memory (Solid State Drive - SSD) (internal via CF slot)
Graphics controller	Integrated Intel Gen. 7 HD Graphics
Operating system	Windows Embedded Compact 7 (WEC7)
Image	SPSPlus Runtime (requires SPSPlusWIN V 6)
	Movicon CE 4096 I/O

3.1.3 All devices starting from hardware revision 03.00.x7

Type of data memory	Flash memory M.2 (Solid State Drive - SSD) (internal via SATA)
Storage capacity of data memory	Note: The indication of the available data storage capacity may vary slightly, since the manufacturers reserve a certain area (spare bytes) to ensure long-term stability.

3.1.4 All devices starting from hardware revision 03.00.x8

Processor	Intel Bay Trail (BT) Atom E3845 quad core; 1.91 GHz		
RAM	4 GB		
Data memory	Size	TBW	Test profile
	64 GB	18.75	JESD218 Client profile
Type of data memory	Flash memory M.2 (Solid State Drive - SSD) (internal via SATA)		
Storage capacity of data memory	Note: The indication of the available data storage capacity may vary slightly, since the manufacturers reserve a certain area (spare bytes) to ensure long-term stability.		
Graphics controller	Integrated Intel Gen. 7 HD Graphics		

3.2 Additionally for ET-4x6-A-* (Panel PC)

3.2.1 All devices up to hardware revision 03.00.x2

Processor	Intel Atom N270; 1.6 GHz
RAM	1 or 2 GB
Data memory	4 or 16 GB
	128 GB MLC
	128 GB SLC
Type of data memory	Flash memory (SATA)
Operating system	Windows XP Embedded / Windows XP Professional / Windows 7 Ultimate
Global language support	Via Multi-Language interface of Windows XP Embedded (25 languages)

3.2.2 All devices starting from hardware revision 03.00.x4

Processor	Intel Bay Trail (BT) Atom E3845 Quad Core; 1.91 GHz		
RAM	4 GB		
Data memory	Size	TBW	Test profile
	64 GB MLC	18.75	JESD218 Client profile
	128 GB MLC	37.5	
Type of data memory	Flash memory (Solid state drive - SSD) (internal via CF slot)		
Graphics controller	Integrated Intel Gen. 7 HD Graphics		
Operating system	Windows Embedded Standard 7 / Windows 7 Ultimate		
	Windows 10 IoT Enterprise (64 bit) (included in standard delivery)		
	Windows 10 IoT Enterprise (32 bit) (optional on USB stick)		
Global language support	Via Windows operating system		

3.2.3 All devices starting from hardware revision 03.00.x6

Type of data memory	Flash memory M.2 (Solid State Drive - SSD) (internal via SATA)
Storage capacity of data memory	Note: The indication of the available data storage capacity may vary slightly, since the manufacturers reserve a certain area (spare bytes) to ensure long-term stability.

3.3 Additionally for ET-5x6-A-* (Thin Clients)

3.3.1 All devices up to hardware revision 03.00.x2

Processor	AMD Geode LX 800; 266 MHz
RAM	512 MB
	2 GB *
Data memory	1 GB
	16 GB *
Operating system	Windows Embedded Standard 2009 and Remote Firmware
	Windows Embedded Standard 7, Remote Firmware and Delta V *

NOTICE	* The combination of 2 GB RAM with 16 GB data memory is only available for the operating system with Delta V !
---------------	--

3.3.2 All devices starting from hardware revision 03.00.x4

Processor	Intel Bay Trail (BT) Atom E3845 Quad Core; 1.91 GHz
RAM	4 GB
Data memory	64 GB
Type of data memory	Flash memory (Solid state drive - SSD) (internal via CF slot)
Graphics controller	Integrated Intel Gen. 7 HD Graphics
Operating system	Windows 10 IoT Enterprise and Remote Firmware

3.3.3 All devices starting from hardware revision 03.00.x6

Data memory	Size	TBW	Test profile
	64 GB MLC	18.75	JESD218 Client profile
	128 GB MLC	37.5	
Type of data memory	Flash memory M.2 (Solid State Drive - SSD) (internal via SATA)		
Storage capacity of data memory	Note: The indication of the available data storage capacity may vary slightly, since the manufacturers reserve a certain area (spare bytes) to ensure long-term stability.		

4 Conformity to standards

The ET-xx6-A-* HMI devices comply with the following standards and directives:

Standard	Classification
1st supplement	
ATEX directive 2014/34/EU	
IEC 60079-0 : 2017	General requirements
IEC 60079-1 : 2014	Flameproof enclosure "d"
IEC 60079-7 : 2017	Increased safety "e"
IEC 60079-11 : 2011	Intrinsic safety "i"
IEC 60079-18 : 2018	Encapsulation "m"
IEC 60079-28 : 2015	Optical radiation "op is"
IEC 60079-31 : 2013	Protected by enclosures "t" (dust)
The product corresponds to requirements from:	
EN IEC 60079-0 : 2018	General requirements
EN 60079-1 : 2014	Flameproof enclosure "d"
EN IEC 60079-7 : 2015 + A1 : 2018	Increased safety "e"
EN 60079-11 : 2012	Intrinsic safety "i"
EN 60079-18 : 2015 + A1 : 2017	Encapsulation "m"
EN 60079-28 : 2015	Optical radiation "op is"
EN 60079-31 : 2014	Protected by enclosures "t" (dust)

Electromagnetic compatibility	
EMC directive	
2014/30/EU	Classification
EN 61326-1 : 2013	General requirements
EN 61000-6-2 : 2005	Immunity
EN 61000-6-4 : 2007 + A1 2011	Emission
RoHS directive	
2011/65/EU	Classification
EN IEC 63000 : 2018	Technical documentation for the assessment of electrical and electronic products with respect to the restriction of hazardous substances

5 Certificates

The ET-xx6-A-* HMI devices are certified for installation in the following areas:



Synonym	Scope	Certificate number	Valid until	Comment
CE	Europe			According directive 2014/30/EU 2014/34/EU 2011/65/EU
ATEX	Europe	TÜV 11 ATEX 7041 X	unlimited	Issue: 01
IECEX	Global	IECEX TUR 11.0006X	unlimited	Issue: 3
NEC	USA	UL 20130611-E202379	unlimited	
CE-Code	Canada	CSA 2512677	unlimited	
BIS	India	R-41228087	26.06.2026	Device restriction see notice
PESO		A/P/HQ/TN/104/6108 (P528111)	31.12.2026	Identification numbers
CCE		P528111/1 P528111/2		
INMETRO	Brazil	UL-BR 12.0265X	04.06.2027	Revision: 06
KCC	Korea		unlimited	Device restriction see notice
KCS		12-GA4BO-0215X 12-GA4BO-0317X	unlimited	
CCC	China	2020312309000285	01.09.2025	
RCM	Australia		unlimited	According to declaration of conformity
ABS	Marine- / ship certification	19-HG1895092-PDA	08.10.2024	
DNV		TAA00000WA	05.12.2026	
LR		LR21402888TA	28.09.2026	

 DOCUMENTATION	You can access all IECEx certificates on the official website of the IEC under their certificate number. https://www.iecex-certs.com/#/home
--	---

 NOTICE	BIS: The following devices have the BIS certification: ET-316-A-FX, ET-316-A-TX, ET-416-A-FX, ET-416-A-TX, ET-516-A-FX, ET-516-A-TX ET-336-A-FX, ET-336-A-TX, ET-436-A-FX, ET-436-A-TX, ET-536-A-FX, ET-536-A-TX
---	--

 NOTICE	<p>In order to be able to operate these HMI devices in Korea, each device type additionally requires a KCC certificate. Actually the following devices has such a certificate: ET-316-A-*, MT-316-A-*, ET-416-A-*, MT-416-A-*, ET-436-A-*, MT-436-A-*, ET-456-A-TX</p>
	<p>The importer have to use exception documents which are applied in Korea rule for Korea. A corresponding example document, the so-called "Customer confirmation letter", is included in the CE_ET-xx6-A certificate compilation of the devices.</p>

6 Marking

Manufacturer	R. STAHL HMI Systems GmbH	
Type code	ET-3x6-A-* / ET-4x6-A-* / ET-5x6-A-*	
CE classification:	CE 0158	
Testing authority and certificate number:	TÜV 11 ATEX 7041 X IECEX TUR 11.0006X	
Ex classification:		
ATEX ET-xx6-A-TX		II 2 (2) G Ex db eb ia ib mb [ia ib] IIC T4 Gb II 2 (2) D Ex ia tb [ia ib] IIIC T80°C IP66 Db
ET-xx6-A-FX		II 2 (2) G Ex db eb ia ib mb [ia ib op is] IIC T4 Gb II 2 (2) D Ex ia tb [ia ib op is] IIIC T80°C IP66 Db
IECEX ET-xx6-A-TX		Ex db eb ia ib mb [ia ib] IIC T4 Gb Ex ia tb [ia ib] IIIC T80°C IP66 Db
ET-xx6-A-FX		Ex db eb ia ib mb [ia ib op is] IIC T4 Gb Ex ia tb [ia ib op is] IIIC T80°C IP66 Db
NEC		Class I, Division 2, Groups A, B, C, D Class II, Division 2, Groups F, G Class III Class I, Zone 2, Group IIC
CE-Code		Ex d e ia ib mb [ia ib] IIC T4 Gb, Type 4X, IP66 Ex ia tb [ia ib] IIIC T80°C Db, IP66 Class II, Division 1, Groups E, F, G, T80°C
PESO ET-xx6-A-TX		Ex db eb ia ib mb [ia ib] IIC T4 Gb
ET-xx6-A-FX		Ex db eb ia ib mb [ia ib op is] IIC T4 Gb
INMETRO ET-xx6-A-TX		Ex db eb ia ib mb [ia ib] IIC T4 Gb Ex ia tb [ia ib] IIIC T80°C IP66 Db
ET-xx6-A-FX		Ex db eb ia ib mb [ia ib op is] IIC T4 Gb Ex ia tb [ia ib op is] IIIC T80°C IP66 Db

CCC ET-xx6-A-TX		Ex db eb ia ib mb [ia ib Gb] IIC T4 Gb Ex ia tb [ia ib Db] IIIC T80°C Db
ET-xx6-A-FX		Ex db eb ia ib mb [ia ib op is Gb] IIC T4 Gb Ex ia tb [ia ib op is Db] IIIC T80°C Db
KCC / KCS		Ex d e ia ib mb [ia ib] IIC T4 Ex ia tb [ia ib] IIIC T80°C Db IP66

7 Power supply

7.1 HMI devices

Power supply: 24.0 VDC
 (min. 20.4 VDC , max. 28.8 VDC / (-15 % / +20 %))
 Up from 100 GB data memory (min. 21.6 VDC , max. 28.8 VDC / (-10 % / +20 %))

Power consumption: 1.2 A

7.1.1 HMI device terminals

Copper wires with cross sections of between 0.2 mm² (AWG24) and 2.5 mm² (AWG14) may be connected to any of the terminals of the HMI devices.

 NOTICE	When connecting cables to the terminals please make sure that the insulation of the cables goes right up to the terminal contacts.
---	--

7.1.1.1 Tightening torque

For the terminals X1 and X11 a tightening torque of:
 0.4 Nm up to 0.5 Nm is valid
 and for the terminals X2, X3, X4, X5, X6, X7, X8 and X9 a tightening torque of:
 0.5 Nm bis 0.6 Nm is valid.

 NOTICE	The stipulated tightening torques of the connection terminals must be observed and applied. Again, they must be checked and possibly adjusted before commissioning !
---	--

8 Permitted maximum values

8.1 External, non-intrinsically safe circuits

Input voltage (X1):

Rated voltage	24 VDC (+20 % / -15 %)
Power consumption at U_{rated}	1.5 A max
max. working voltage U_m	30 VDC

RS-422/-232 COM 1 (X2):

Rated voltage	RS-422: 5 VDC	RS-232: ± 12 VDC
Max. operating voltage U_m	253 VAC	

USB-1 (X5):

Rated voltage	5 VDC
Max. operating voltage U_m	253 VAC

USB-3 (X7):

Rated voltage	5 VDC
Max. operating voltage U_m	253 VAC

Copper Ethernet (X11):

Rated voltage	5 VDC
Rated power	100 mW
Max. operating voltage U_m	30 VDC

Audio (X3):

Rated voltage	5 VDC
Max. operating voltage U_m	253 VAC

8.2 External inherently safe optical interface

Ethernet optical fiber (X10):

Wavelength	1350 nm
Radiant power	≤ 35 mW

8.3 External intrinsically safe circuits

USB0 (X4):

The maximum values for group IIC are:

U _i	=	-	V		U _o	=	5.9	V											
I _i	=	-	mA		I _o	=	2.18	A											
P _i	=	-	mW		P _o	=	1.24	W											
C _i	=	0	μF		C _o	=	5.1	11	28	43	μF								
L _i	=	0	mH		L _o	=	10	5	2	1	μH								

C_o and L_o pairs directly above/underneath each other may be used.

The maximum values for group IIB are:

U _i	=	-	V		U _o	=	5.9	V											
I _i	=	-	mA		I _o	=	2.18	A											
P _i	=	-	mW		P _o	=	1.24	W											
C _i	=	0	μF		C _o	=	14	40	79	200	μF								
L _i	=	0	mH		L _o	=	50	20	10	5	μH								

C_o and L_o pairs directly above/underneath each other may be used.

USB-2 (X6):

The maximum values for group IIC are:

U _i	=	-	V		U _o	=	5.9	V											
I _i	=	-	mA		I _o	=	2.18	A											
P _i	=	-	mW		P _o	=	1.24	W											
C _i	=	0	μF		C _o	=	5.1	11	28	43	μF								
L _i	=	0	mH		L _o	=	10	5	2	1	μH								

C_o and L_o pairs directly above/underneath each other may be used.

The maximum values for group IIB are:

U _i	=	-	V		U _o	=	5.9	V											
I _i	=	-	mA		I _o	=	2.18	A											
P _i	=	-	mW		P _o	=	1.24	W											
C _i	=	0	μF		C _o	=	14	40	79	200	μF								
L _i	=	0	mH		L _o	=	50	20	10	5	μH								

C_o and L_o pairs directly above/underneath each other may be used.

Reader RSi1 (X8) +U_{int} 1 (power supply circuit, X8.0, bridge to X8.2):

U _o	=	10.4	V
I _o	=	220	mA
P _o	=	2.29	W
C _o	=	0.08	μF
L _o	=	0.01	mH

Reader RSi1 (X8) +U_{ex}1 (power supply circuit, X8.2, bridge from X8.0):

U _i	=	12.4	V
I _i	=	220	mA
P _i	=	2.29	mW
C _i	=	25	nF
L _i	=	0	mH

Reader RSi1 (power supply reader, X8.3-4):

The maximum values for group IIC are:

U_i	=	-	V		U_o	=	5.36	V				
I_i	=	-	mA		I_o	=	220	mA				
P_i	=	-	W		P_o	=	1.18	W				
C_i	=	5.3	μ F		C_o	=	40.7	59.7	μ F			
L_i	=	0	mH		L_o	=	2	1	μ H			

C_o and L_o pairs directly above/underneath each other may be used.

The maximum values for group IIB are:

U_i	=	-	V		U_o	=	5.36	V				
I_i	=	-	mA		I_o	=	220	mA				
P_i	=	-	W		P_o	=	1.18	W				
C_i	=	5.3	μ F		C_o	=	70.7	124.7	μ F			
L_i	=	0	mH		L_o	=	20	10	μ H			

C_o and L_o pairs directly above/underneath each other may be used.

Reader RSi1 and RSi2 (signal input / output, X8.5-8):

The maximum values for group IIC are:

U_i	=	15	V		U_o	=	5.36	V				
I_i	=	500	mA		I_o	=	46	mA				
P_i	=	2.5	W		P_o	=	62	mW				
C_i	=	0	μ F		C_o	=	46	μ F				
L_i	=	0	mH		L_o	=	2	μ H				

The maximum values for group IIB are:

U_i	=	15	V		U_o	=	5.36	V				
I_i	=	500	mA		I_o	=	46	mA				
P_i	=	2.5	W		P_o	=	62	mW				
C_i	=	0	μ F		C_o	=	79	μ F				
L_i	=	0	mH		L_o	=	20	mH				

Reader WCR1 (X8) (connection voltage supply, X8.1-2):

U_i	=	11.4	V									
I_i	=	200	mA									
P_i	=	2.28	W									
C_i	=	25	nF									
L_i	=	0	mH									

Reader WCR1 (power supply reader, X8.3-4):

The maximum values for group IIC are:

U_i	=	-	V		U_o	=	5.88	V				
I_i	=	-	mA		I_o	=	200	mA				
P_i	=	-	mW		P_o	=	1.18	W				
C_i	=	5.3	μ F		C_o	=	27.7	37.7	μ F			
L_i	=	0	mH		L_o	=	2	1	μ H			

C_o and L_o pairs directly above/underneath each other may be used.

The maximum values for group IIB are:

U_i	=	-	V		U_o	=	5.88	V	
I_i	=	-	mA		I_o	=	200	mA	
P_i	=	-	mW		P_o	=	1.18	W	
C_i	=	5.3	μ F		C_o	=	55.7	94.7	μ F
L_i	=	0	mH		L_o	=	20	10	μ H

C_o and L_o pairs directly above/underneath each other may be used.

Reader WCR1 and WCR2 (signal input / output, X8.5-8):

The maximum values for group IIC are:

U_i	=	15	V		U_o	=	5.88	V	
I_i	=	500	mA		I_o	=	51	mA	
P_i	=	2.5	W		P_o	=	75	mW	
C_i	=	0	μ F		C_o	=	34	μ F	
L_i	=	0	mH		L_o	=	2	μ H	

The maximum values for group IIB are:

U_i	=	15	V		U_o	=	5.88	V	
I_i	=	500	mA		I_o	=	51	mA	
P_i	=	2.5	W		P_o	=	75	mW	
C_i	=	0	μ F		C_o	=	63	μ F	
L_i	=	0	mH		L_o	=	20	μ H	

PS2 interface (X9):

Connection for keyboard, mouse, trackball, joystick

The maximum values for group IIC are:

U_i	=	-	V		U_o	=	5.88	V	
I_i	=	-	mA		I_o	=	200	mA	
P_i	=	-	mW		P_o	=	1.18	W	
C_i	=	17.6	μ F		C_o	=	15.4	25.4	μ F
L_i	=	0	mH		L_o	=	2	1	μ H

C_o and L_o pairs directly above/underneath each other may be used.

The maximum values for group IIB are:

U_i	=	-	V		U_o	=	5.88	V			
I_i	=	-	mA		I_o	=	200	mA			
P_i	=	-	mW		P_o	=	1.18	W			
C_i	=	17.6	μ F		C_o	=	10.4	20.4	43.4	82.4	μ F
L_i	=	0	mH		L_o	=	100	50	20	10	μ H

C_o and L_o pairs directly above/underneath each other may be used.



ATTENTION

Do **NOT** connect the optional external keyboard to live equipment !

9 Type code

9.1 Certificate

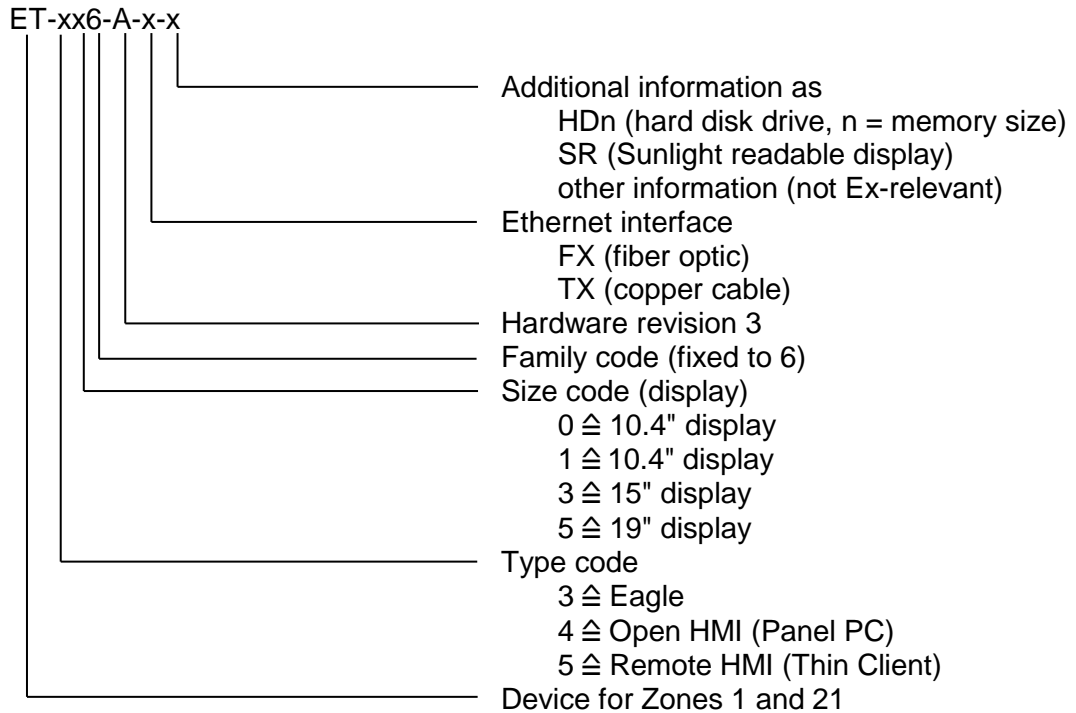

9.2 Variants

9.2.1 ET-3x6-A-*-BS (Operator Interfaces)

NOTICE

These versions apply to all Operator Interfaces starting from hardware revision 03.00.x5, with Bay Trail Atom E3815 single core processor.

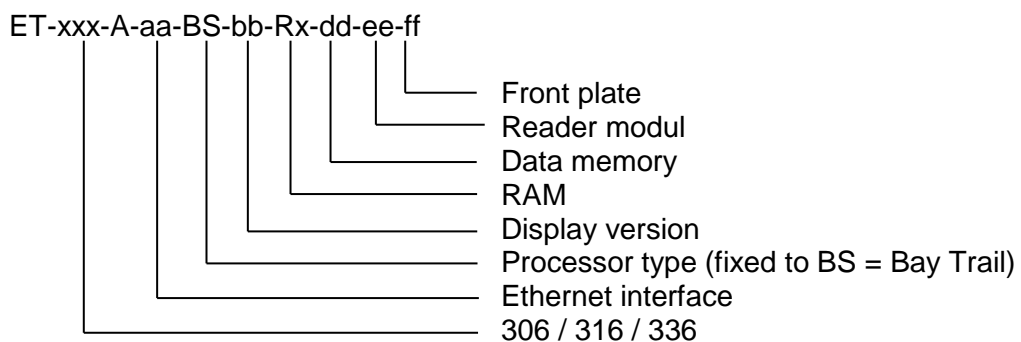

Device variant:

Classification product key	Description
	Type with
ET-3x6-A- FX -BS-bb-Rx-dd-ee-ff	Optical fiber Ethernet interface 100Base-FX (Ex op is)
ET-3x6-A- TX -BS-bb-Rx-dd-ee-ff	Copper Ethernet interface 10/100Base-TX (Ex e)
ET-3x6-A-aa-BS- TFT -Rx-dd-ee-ff	TFT Display (Standard)
ET-3x6-A-aa-BS- SR -Rx-dd-ee-ff	Sunlight readable Display 1000 cd/m ² (only ET-336-A-*-BS) (no longer available)
ET-3x6-A-aa-BS-bb- R2 -dd-ee-ff	2 GB RAM
ET-3x6-A-aa-BS-bb-Rx- 16GB -ee-ff	16 GB Solid State Drive
ET-3x6-A-aa-BS-bb-Rx-dd- RSi1 -ff	Plug-in module for reader with RS-232 interface, power supply via HMI device
ET-3x6-A-aa-BS-bb-Rx-dd-ee- PES	Polyester front plate

9.2.2 ET-3x6-A-*-BT (Operator Interfaces)

 NOTICE	These versions apply to all Operator Interfaces starting from hardware revision 03.00.x8, with Bay Trail Atom E3845 quad core processor.
---	--

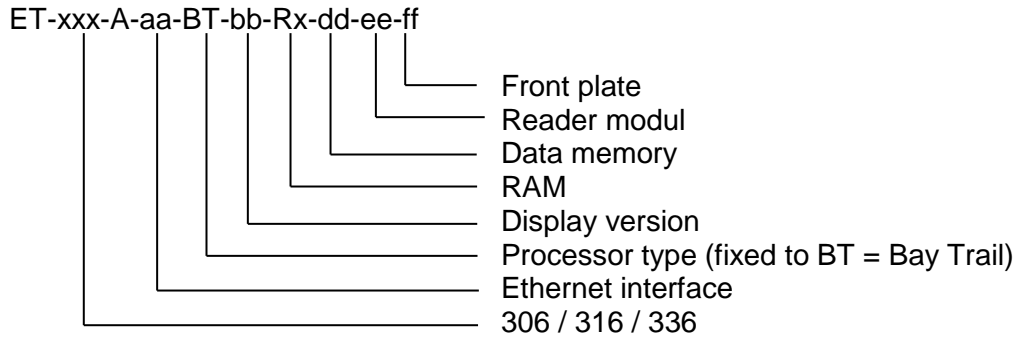

Device variant:

Classification product key	Description
	Type with
ET-3x6-A- FX -BT-bb-Rx-dd-ee-ff	Optical fiber Ethernet interface 100Base-FX (Ex op is)
ET-3x6-A- TX -BT-bb-Rx-dd-ee-ff	Copper Ethernet interface 10/100Base-TX (Ex e)
ET-3x6-A-aa-BT- TFT -Rx-dd-ee-ff	TFT Display (Standard)
ET-3x6-A-aa-BT-bb- R3 -dd-ee-ff	4 GB RAM
ET-3x6-A-aa-BT-bb-Rx- 64GB -ee-ff	64 GB Solid State Drive
ET-3x6-A-aa-BT-bb-Rx-dd- RSi1 -ff	Plug-in module for reader with RS-232 interface, power supply via HMI device
ET-3x6-A-aa-BT-bb-Rx-dd-ee- PES	Polyester front plate

9.2.3 ET-4x6-A-*-BT (Panel PC)

**NOTICE**

These versions apply to all Panel PC's starting from hardware revision 03.00.x4, with Bay Trail Atom E3845 quad core processor.

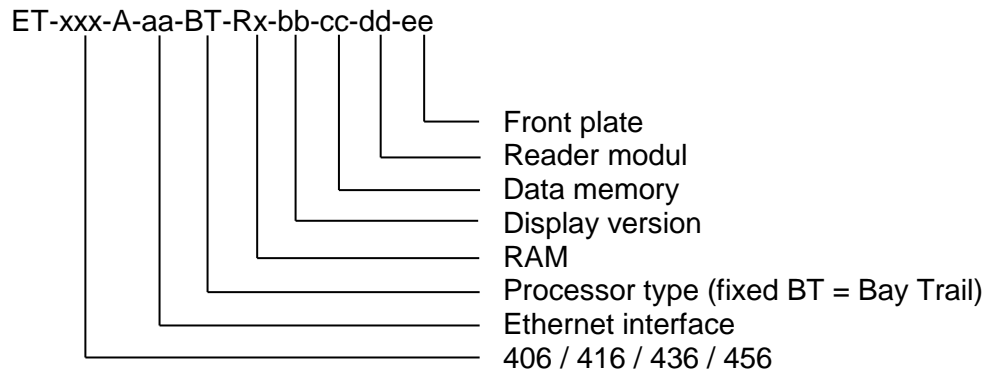

Device variant:

Classification product key	Description
	Type with
ET-4x6-A- FX -BT-Rx-bb-cc-dd-ee	Optical fiber Ethernet interface 100Base-FX (Ex op is)
ET-4x6-A- TX -BT-Rx-bb-cc-dd-ee	Copper Ethernet interface 10/100Base-TX (Ex e)
ET-4x6-A-aa-BT- R3 -bb-cc-dd-ee	RAM 4 GB
ET-4x6-A-aa-BT-Rx- TFT -bb-cc-dd-ee	TFT display (standard)
ET-4x6-A-aa-BT-Rx- SR -bb-cc-dd-ee	Sunlight readable display 1000 cd/m ² (ET-436-A-*-BT only) (no longer available)
ET-4x6-A-aa-BT-Rx-bb- 64GB -dd-ee	64 GB Solid State Drive MLC
ET-4x6-A-aa-BT-Rx-bb- 128GBM -dd-ee	128 GB Solid State Drive MLC
ET-4x6-A-aa-BT-Rx-bb-cc- RSi1 -ee	Plug-in module for reader with RS-232 interface, power supply via HMI device
ET-4x6-A-aa-BT-Rx-bb-cc-dd- PES	Polyester front plate
ET-4x6-A-aa-BT-Rx-bb-cc-dd- VA	Stainless steel front plate (436 and 456 only), NOT SR type

9.2.4 ET-5x6-A-*-BT (Thin Client)

 NOTICE	These versions apply to all Thin Client's starting from hardware revision 03.00.x4, with Bay Trail Atom E3845 quad core processor.
---	--

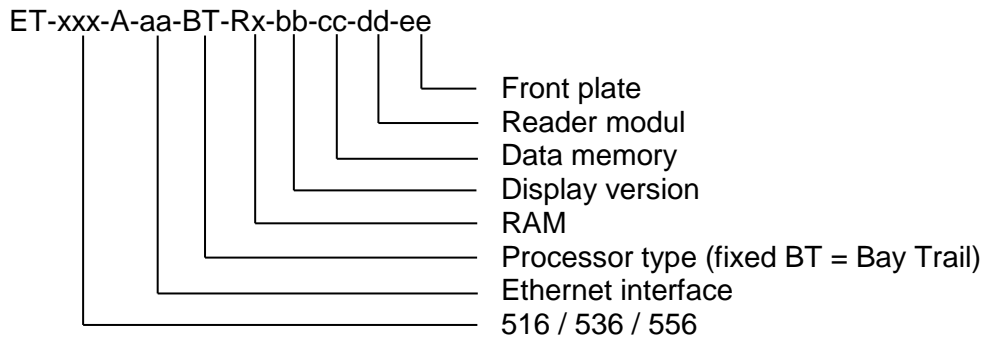

Device variant:

Classification product key	Description
	Type with
ET-5x6-A- FX -BT-Rx-bb-cc-dd-ee	Optical fiber Ethernet interface 100Base-FX (Ex op is)
ET-5x6-A- TX -BT-Rx-bb-cc-dd-ee	Copper Ethernet interface 10/100Base-TX (Ex e)
ET-5x6-A-aa-BT- R3 -bb-cc-dd-ee	RAM 4 GB
ET-5x6-A-aa-BT-Rx- TFT -bb-cc-dd-ee	TFT display (standard)
ET-5x6-A-aa-BT-Rx- SR -bb-cc-dd-ee	Sunlight readable display 1000 cd/m ² (ET-536-A-*-BT only) (no longer available)
ET-5x6-A-aa-BT-Rx-bb- 64GB -dd-ee	64 GB Solid State Drive (SSD)
ET-5x6-A-aa-BT-Rx-bb- 128GB -dd-ee	128 GB Solid State Drive (SSD)
ET-5x6-A-aa-BT-Rx-bb-cc- RSi1 -ee	Plug-in module for reader with RS-232 interface, power supply via HMI device
ET-5x6-A-aa-BT-Rx-bb-cc-dd- PES	Polyester front plate
ET-5x6-A-aa-BT-Rx-bb-cc-dd- VA	Stainless steel front plate, NOT SR type

10 Safety Advice

 NOTICE	This chapter is a summary of the key safety measures. The summary is supplementary to existing rules which staff also have to study.
	The safety of persons and equipment in hazardous areas depends on compliance with all relevant safety regulations. Thus, the installation and maintenance staff carry a particular responsibility, requiring precise knowledge of the applicable regulations and conditions.

 CAUTION	The notes listed below in section 10.1 must be heeded to avoid injury and damage to equipment !
--	---

10.1 Installation and operation

Please note the following when installing and operating the device:

- The in each case valid national regulations for installation and assembly apply (e.g. IEC/EN 60079-14).
- The HMI device has been certified as a fixed installed device. It must be fixed with a bracket or be secured in another way at a specified position.
- The HMI device must be disconnected from the mains for a change of position. The EPL must be adhered to.
- The HMI device must only be switched on when it is closed.
- The HMI devices may be installed in zones 1, 2, 21 or 22.
- For use according to NEC, please refer to drawings 201717540 and 201133510. Any pre-installations made ex-factory may have to be complemented accordingly.
- The intrinsically safe circuits must be installed according to applicable regulations.
- When installed in zones 1, 2, 21 and 22, intrinsically safe devices suitable for categories 2G, 3G, 2D and 3D may be connected to the intrinsically safe power supply circuits.
- If the HMI devices are installed in areas exposed to the risk of dust explosions, the maximum values of Group IIB apply to the intrinsically safe circuits.
- Interconnecting several active devices in an intrinsically safe circuit may result in different safe maximum values. This could compromise intrinsic safety !
- The safe maximum values of the connected field device(s) must correspond to the values listed on the data sheet or the EC type examination certificate.
- During assembly and operation of the HMI device electrostatic surface charging must not exceed that caused by manual rubbing.
- After switching the HMI device off, wait for at least 1 minute before opening it.
- Before opening the housing lid users must ensure that all non-intrinsically safe circuits have been switched off. Circuits supplied from different sources may be connected ! Please note that all associated equipment (such as the SK-KJ1710, for example) must also be switched off !
- The HMI device and any connected equipment must be incorporated into the same potential equalization system (see installation example in the Hardware Manual). An alternative would be to connect only devices that are safely isolated from earth potential.
- National safety and accident prevention rules.

- Generally accepted technical rules.
- Safety instructions contained in these operating instructions.
- Any damage may compromise the explosion protection !

Use the device for its intended purpose only (see "[Device Function](#)").

Incorrect or unauthorized use and non-compliance with the instructions in this manual will void any warranty on our part.

No changes to the device that compromise its explosion protection are permitted !

The device may only be installed and operated in an undamaged, dry and clean condition !

10.2 Cautionary notes

 ATTENTION	This is an EN 55022 Class A product. In a domestic environment this product may cause radio interference in which case the user may be required to take adequate measures.
--	---

 WARNING	Explosion Hazard ! Substitution of any components may impair suitability for Class I, Division 2 !
	Explosion Hazard ! Do not disconnect Equipment while the circuits is life or unless the area is know to be free of ignitable concentrations !

10.3 Special conditions

 CAUTION	The fronts of the HMI devices with a sunlight readable display (type code includes "SR") may be cleaned with a damp cloth only.
--	---

10.4 Industrial Security

Our products with Industrial Security functions support the secure operation of plants, systems and equipment. Protection against cyber threats requires an all-encompassing Industrial Security concept. The key to a successful concept is integrated implementation, continuous maintenance and state-of-the-art technology. This is the responsibility of the plant operator.

The following are key issues for an effective Industrial Security concept:

- Prevention of unauthorised access to plants, systems, equipment and networks
- Systems, equipment and components should only be connected to the company intranet or the internet if and when required
- Employ protective measures such as firewalls and network segmentation
- Only use the latest software product versions
- Carry out software updates as soon as new versions are available
- Use standard user accounts for regular operation
- Use secure passwords
- Appropriate safeguarding of administrator accounts
- Application of security guidelines
- Other measures to be taken as required

R. STAHL uses Windows 10 for its products. It does not develop any cryptographic functions. R. STAHL does not configure / harden the operating system, nor does it provide or refer to security guidelines for doing so. Furthermore, R. STAHL is constantly working on enhancing its products, thereby contributing to plant security and to minimizing the risk of cyber threats.

11 Installation

11.1 General information

 NOTICE	<p>Electrical plants are subject to certain regulations concerning installation and operation (e.g. RL 1999/92/EC, RL 2014/34/EU and IEC/EN 60079-14).</p> <p>It is the responsibility of the operators of electrical installations in hazardous environments to ensure that the equipment is kept in proper condition, is operated according to instructions and that maintenance and repairs are carried out.</p>
---	---

11.2 ET-xx6-A-*

- Operators must ensure compliance with the examination certificates before installation. Users must adhere to any “special conditions” therein. Also of importance are the maximum electrical operating values specified therein.
- The earth / ground (PE) connector at the back of the HMI device housing must be connected to the equipotential bonding conductor of the hazardous area. The earthing cable's cross section must be at least 4 mm² (AWG12) and it must be fitted with a suitable cable lug. To prevent equalizing currents flowing to the earth / ground (PE) system of the HMI device it is necessary to safely isolate any connected devices from earth or to integrate them into the earth / ground (PE) system of the HMI device.
- The PE connection part of the HMI device located at the back of the housing is internally connected with the GND supply cable (X1 pins 3 and 4).
- The HMI devices can be mounted and operated in any position. Sufficient air circulation must be ensured, however, so that the maximum operating temperature is not exceeded.
- Intrinsically safe and non intrinsically safe conducting connection parts must be installed with a minimum distance of 50 mm [0.16 ft].
- When connecting the HMI devices to the intrinsically safe circuits of the associated equipment the respective maximum values of the field unit and the associated equipment must be observed to ensure explosion protection (proof of intrinsic safety).
- The HMI device's front should be protected by a canopy against permanent exposure to UV light. This increases the front membrane's lifespan. The canopy **MUST NOT** be too close to the front plate and sufficient air circulation must be ensured.
- The ET-4x6-A-* and ET-5x6-A-* devices may be operated at +55 °C [+131 °F] **ONLY FOR SHORT PERIODS** at a time.

11.2.1 HMI device Installation in housings type of protection "e" or "t"

If the HMI devices ET-xx6-A-* are mounted inside a cut out of a suitable housing of protection type Ex e or Ex t, its mechanical protection regarding impact and IP code protection up to IP65 is maintained even after the device has been installed. The internal separation requirements and the temperature assessment of the Ex e housing must be in accordance with the applicable standards. The clearance of HMI device terminals to other bare conducting parts (excepting ground) inside the Ex e housing shall be at least 50 mm [0.16 ft].

11.2.2 Cable glands

The HMI devices of the EAGLE device platform (ET-xx6-A) are factory-fitted with cable glands of the type STAHL 8161/* (Ex i - connections) and of the type HSK-M-Ex (Ex e connections). These are selected so that they comply with all relevant approvals for the device. The Ex-relevant markings on the device also contain the bushings and are not necessarily specially marked when the device is shipped from the factory. The following must be observed:

- Unused cable glands must be closed with certified screw plugs or stopping plugs.
- The tightening torques for the cable glands may vary depending on the cables and wires used. The users have to determine and apply the required torques themselves.
- In the case of ex-factory systems, all components are installed correctly and in accordance with applicable standards. Since storage or temperature etc. can have an impact on the cables and cable glands, the pre-installed screw connections must be checked and possibly tightened before commissioning.
- If they are too loose or too tight, the type of protection, sealing or strain relief might be negatively impacted.
- Cable glands with cap nut and without strain relief clamp should only be used for permanently installed cables and electrical lines. Installation of the required strain relief is the responsibility of the system set-up engineer.

Alternative, similar and certified cable glands may be used provided they have an equal or higher area of certification (zone) and permitted temperature range, and the same country approval (e.g. ATEX for Europe) as the HMI device.

Open enclosure holes without cable glands are not permitted and must be closed with a certified screw plug. This certified screw plug must have an equal or higher area of certification (zone) and permitted temperature range, and the same country approval (e.g. ATEX for Europe) as the HMI device.

11.3 Usage of the USB-interfaces

Hardware and connection				
connection to	intrinsic safety USB devices		intrinsically safe equipment	
	safe area	hazardous areas	safe area	hazardous areas
X4 (I.S.)	x	-	-	-
X6 (I.S.)	-	via VB-USB-Plug	-	-
X5 (Ex e)	-		via VB-USB-INST1	explosion-proof, but not intrinsically safe devices
X7 (Ex e)				
Functionality and application				
ET-3x6-A-*	Project transfer (SPSPlusWIN project)		-	corresponding device function *
	Device back-up		-	
ET-4x6-A-*	Restore factory state		Software installations	
	Creation of User / OEM back-up		-	
	Software installations		-	
ET-5x6-A-*	Restore factory state		-	
	Import / Export parameters		-	

DOCUMENTATION

* See also [Connection variations for Ex e USB interfaces](#)

11.3.1 Usage of USB Memory-Sticks

ATTENTION

Only USB memory sticks that are certified according to IEC/EN 60079-11 may be used !

NOTICE

In an industrial area, a permitted, explosion proof memory stick may be connected to the I.S. USB interface of the HMI device after having been connected to any PC.

If devices are connected to the I.S. USB interface that have not been approved by R. STAHL HMI Systems GmbH, protective elements may become damaged, thus compromising the intrinsic safety of the interfaces.

In this case R. STAHL HMI Systems can no longer guarantee the intrinsic safety of the device !

11.3.2 Usage of external USB devices

NOTICE

Not applicable to ET-5x6-A-*

Software may be installed with the aid of any external USB devices subject to the following conditions:

- The software is installed in the safe area.
- The USB devices are connected to the Ex e USB interfaces USB1 or USB3 (X5 or X7) with the VB-USB-INST1 connection cable.

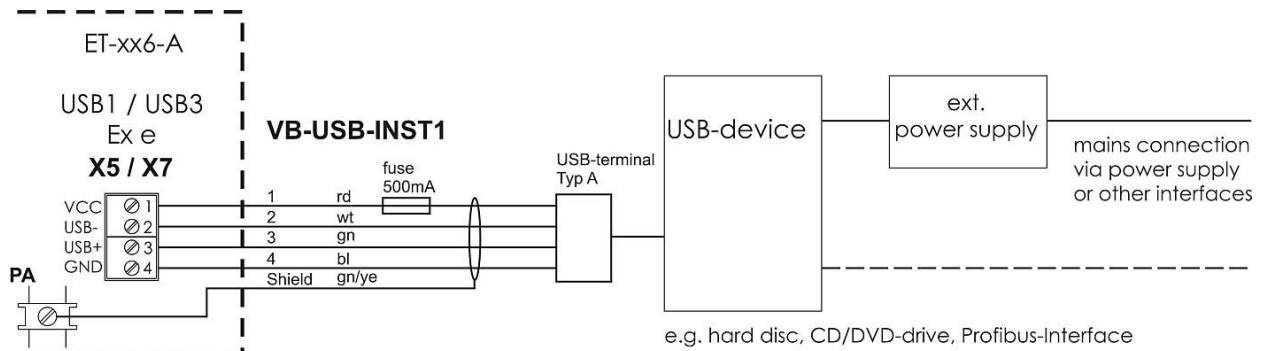

Connection diagram with VB-USB-INST1 (hard disk, CD / DVD with power supply)

 ATTENTION	Direct connections to the HMI devices must be via VB-USB-INST1 ! Otherwise, the internal circuits may become damaged and the explosion-protection of the HMI device may become compromised !
--	---

11.4 USB interfaces

The ET-xx6-A-* device series have 4 USB interface channels.

- USB0 at X4 for the internal connection of a USB Drive.
- USB1 at X5 for the connection of external USB devices.
- USB2 at X6 for the connection of an external USB Drive.
- USB3 at X7 for the connection of external USB devices.

 DOCUMENTATION	The connection diagram for the ET-xx6-A-* interfaces can be found in chapter connections .
--	--

11.4.1 I.S. USB interfaces USB0, USB2

The USB0 and USB2 I.S. interfaces (X4 and X6) are intended for the internal or external connection of USBi Drives.

The maximum value for the joint power supply of USB0 and USB2 is 500 mA.

11.4.2 Ex e USB interfaces USB1, USB3

The USB1 and USB3 Ex e USB interfaces (X5 and X7) are intended for the connection of external USB devices.

The maximum value for the joint power supply of USB1 and USB3 is 500 mA.

11.4.2.1 Connection variations for Ex e USB interfaces

The two Ex e USB interfaces have an identical structure. The X5 (USB 1) and X7 (USB 3) terminals are for the connection of devices that can be both intrinsically safe or not intrinsically safe.

 ATTENTION	If intrinsically safe devices are connected to the Ex e USB interfaces of the ET-xx6-A-* HMI devices, R. STAHL Systems GmbH cannot guarantee that the intrinsic safety of these devices will continue to apply !
--	--

The following versions are possible:

1. If a USB device that is not connected to the mains is connected, voltage can be supplied from the internal power supply (terminal 1).
2. If a USB device that is connected to the mains is connected, the internal power supply (terminal 1) must not be connected. The power must be supplied from an external device.

11.4.2.2 Connection terminal with protection type "e" (IEC/EN 60079-7)

The X5 and X7 connection terminals have protection type "e".

Flexible cables with a cross section of 0.2 – 2.5 mm² (AWG24 - AWG14) can be used.

The maximum cable length for the connection with the Ex e USB interfaces (X5 and X7) is 2.5 m [8.2 ft].

The insulation of the wire must reach right up to the terminal body.

11.4.2.2.1 Type 1 connection version

- The USB device does not require an external power supply as it uses less than 500 mA.
- No connection to the mains via other interfaces, e.g. WLAN stick.

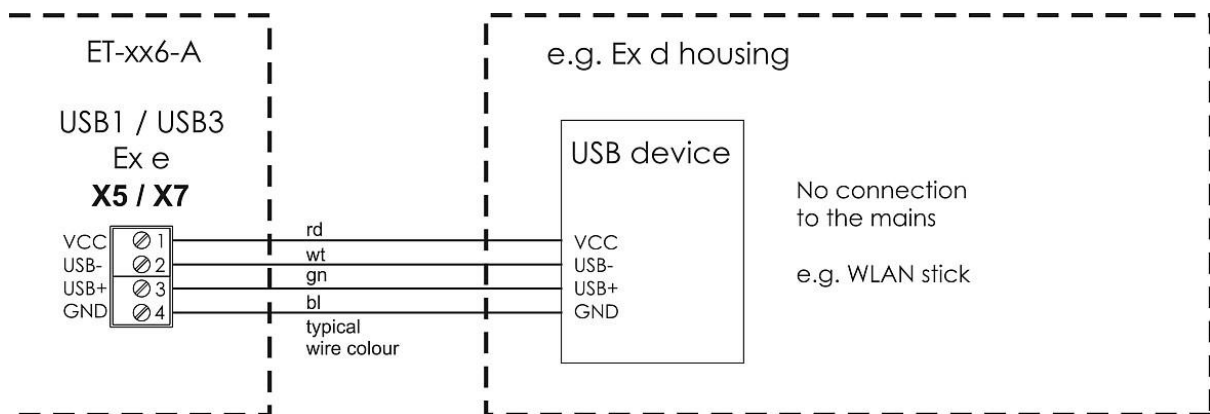

Type 1 connection diagram (e.g. WLAN stick)

11.4.2.2.2 Type 2 connection version

- The USB device does require an external power supply to function because it uses over 500 mA (e.g. hard disks, CD / DVD drives).
- The USB device is connected to the mains via other interfaces (e.g. USB / serial converter).

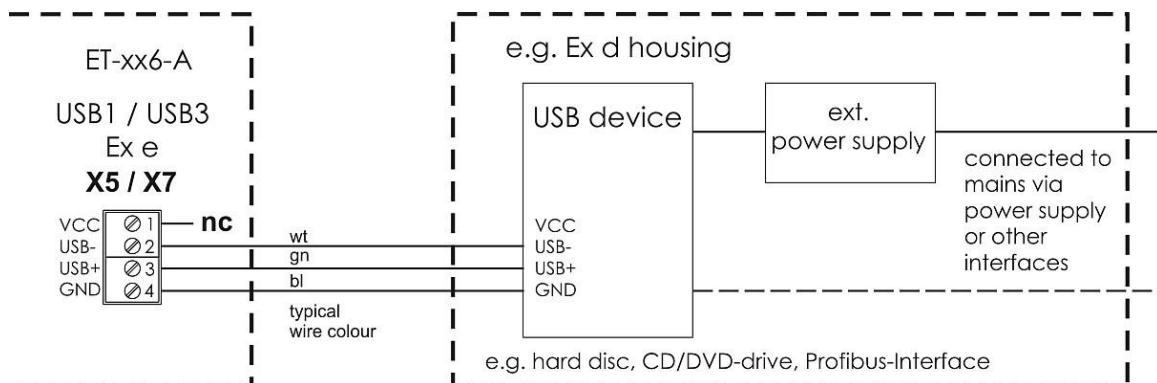

Type 2 connection diagram (e.g. hard disk, CD / DVD with power supply)

11.4.2.2.3 Type 3 connection version

- The USB device does require an external power supply to function because it uses over 500 mA (e.g. hard disks, CD / DVD drives).
- The USB device is connected to the mains via other interfaces (e.g. USB / serial converter).
- The USB device needs the VCC connection of the HMI device (internal supply – terminal 1) to function.

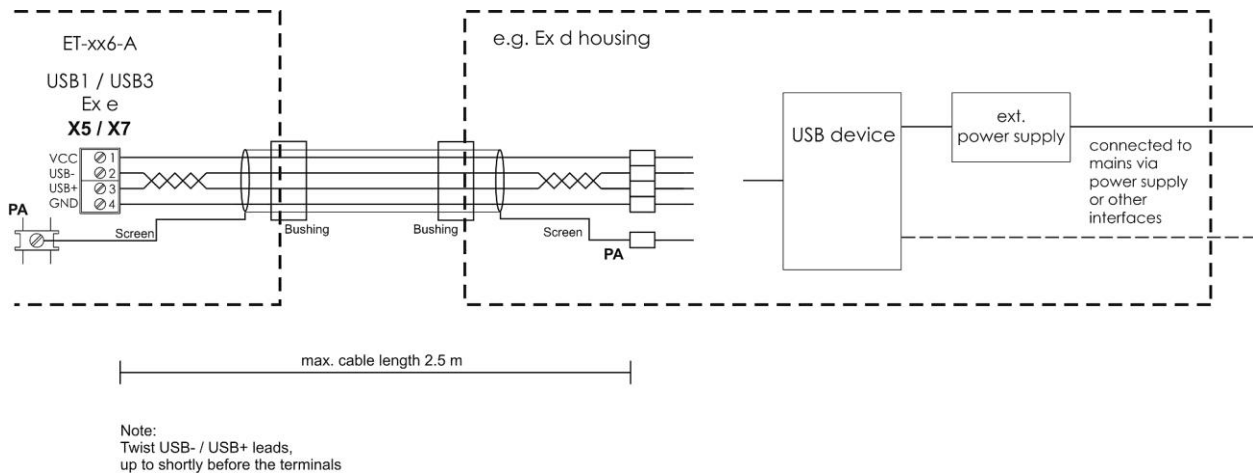

Type 3 connection diagram (any USB device with power supply)

12 Assembly and disassembly

12.1 General information

NOTICE	Assembly and disassembly are subject to general technical rules. Additional, specific safety regulations apply to electronic and pneumatic installations.
---------------	---

12.2 Cut-out ET-xx6-A-*

Make a cut-out with the following dimensions:

HMI device	Width	Height	Depth of cut-out	Material thickness
ET-x06-A-*	385.5 ± 0.5 mm [1.26 ± 0.0016 ft]	257.5 ± 0.5 mm [0.84 ± 0.0016 ft]	150 mm [0.49 ft]	up to 8 mm [0.0087 ft]
ET-x16-A-*	359.5 ± 0.5 mm [1.18 ± 0.0016 ft]	257.5 ± 0.5 mm [0.84 ± 0.0016 ft]	150 mm [0.49 ft]	up to 8 mm [0.0087 ft]
ET-x36-A-*	427.5 ± 0.5 mm [1.40 ± 0.0016 ft]	327.5 ± 0.5 mm [1.07 ± 0.0016 ft]	165 mm [0.54 ft]	up to 8 mm [0.0087 ft]
ET-x56-A-*	522.5 ± 0.5 mm [1.71 ± 0.0016 ft]	412.5 ± 0.5 mm [1.35 ± 0.0016 ft]	165 mm [0.54 ft]	up to 8 mm [0.0087 ft]

12.3 Assembly free area

! NOTICE

The area shown in the sketch must be kept free of all other components or installations !
 When the HMI devices are installed in enclosures supplied by R. STAHL, these requirements are met.

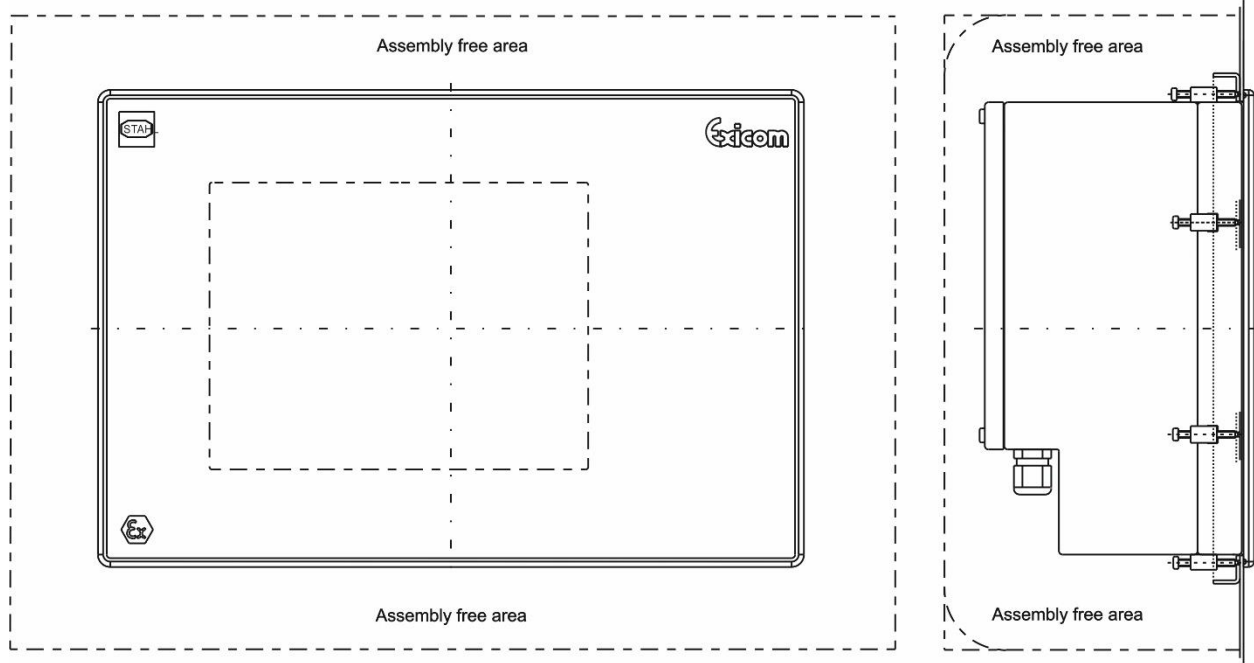

HMI device	Width	Height	Depth
ET-x06-A-*	484 mm [1.59 ft]	356 mm [1.17 ft]	200 mm [0.66 ft]
ET-x16-A-*	458 mm [1.50 ft]	356 mm [1.17 ft]	200 mm [0.66 ft]
ET-x36-A-*	526 mm [1.73 ft]	426 mm [1.40 ft]	200 mm [0.66 ft]
ET-x56-A-*	621 mm [2.04 ft]	511 mm [1.68 ft]	215 mm [0.71 ft]

13 Operation

13.1 General information

	<p>When operating the devices, particular care shall be taken that:</p> <ul style="list-style-type: none"> • the HMI device has been properly installed according to instructions, • the device is undamaged, • the terminal compartment is clean, • all screws are tightened fast, • before switching the HMI device on, its external PE terminal is properly connected to the equipotential bonding system at its place of use, • the cover of the terminal compartment is completely closed.
---	---

13.2 Connections

Terminal	Pin	Definition	Connection
X1	1	Power supply HMI device +24 VDC	Power supply of the HMI device
	2	Power supply HMI device +24 VDC	
	3	Power supply HMI device GND	
	4	Power supply HMI device GND	
X2	1	TxD-b	Serial COM1 interface RS-422/485
	2	TxD-a	
	3	RxD-b	
	4	RxD-a	
	5	TxD-b'	
	6	TxD-a'	
	7	RxD-b'	
	8	RxD-a'	
	9	TxD	Serial COM1 interface RS-232
	10	RxD	
	11	RTS/	
	12	CTS/	
	13	GND	
X3	1	Line out right	Audio Ex e
	2	GND	
	3	Line out left	
X4		USB interface, connection type A - female	USB0 I.S.
X5	1	VCC	USB1 Ex e
	2	USB -	
	3	USB +	
	4	GND	
X6	1	VCC	USB2 I.S.
	2	USB -	
	3	USB +	
	4	GND	
	5	GND	
X7	1	VCC	USB3 Ex e
	2	USB -	
	3	USB +	
	4	GND	

X8	0	+U_INT1	Reader interface I.S.
	1	0V	
	2	+U_EX1	
	3	GND	
	4	+U_RD	
	5	Signal 1	
	6	Signal 2	
	7	Signal 3	
	8	Signal 4	
	9	+U_EX1 (out)	
X9	1	VCC	PS2 interface * I.S. for external keyboard / mouse
	2	KBDAT	
	3	KBCLK	
	4	MSDAT	
	5	MSCLK	
	6	GND	
X10	1	Optical fiber connection type duplex SC - female	Ethernet optical fiber interface **
X11	1	TxD (+)	Ethernet copper connection **
	2	TxD (-)	
	3	RxD (+)	
	4	RxD (-)	

 NOTICE	<p>The COM interface may only be wired as a RS-232 or as a RS-422/485 connection ! Simultaneous wiring of the RS-232 and RS-422/485 interface is not allowed !</p> <p>* Do NOT connect the optional external keyboard to live equipment !</p> <p>** Please note that the Ethernet connection is either for an optical fibre connection (X10) or for a copper connection (X11), depending on the version ordered ! The optical fiber connection requires a multimode optical fiber cable with 62.5 µm core diameter and 125 µm external diameter. When using the fibre optic interfaces of the devices, they must be connected and safely operated with other devices that comply with the limit values of Class 1 according to IEC 60825-1 or are classified as inherently safe optical radiation "op is" according to IEC 60079-28. Copper wires with cross sections of between 0.2 mm² (AWG24) and 2.5 mm² (AWG14) may be connected to any of the terminals of the HMI devices. Which cable cross sections are chosen should be decided on the basis of relevant regulations, such as DIN VDE 0298. Factors that might require a larger cross section, such as current, increased temperatures, cable bundling, etc. must also be taken into account !</p>
---	---

13.2.1 Dip switch settings S3 and S4

Switch	Position	Interface	Function
S3-1	OFF	COM1 RS-422/485	No bus terminator resistor set
	ON		Bus terminator resistor TxD line
S3-2	OFF		No bus terminator resistor set
	ON		Bus terminator resistor RxD line

S4-1	S4-2	S4-3	Interface	Keying
0	0	0	RS-422	Automatic keying
0	1	0		Keying always on
0	0	1		Keying enabled by SW
0	1	1		Driver in idle mode
1	0	0	RS-485	Automatic keying
1	1	0		Status not permitted !!!
1	0	1		Keying enabled by SW
1	1	1		Driver in idle mode
S4-4	OFF		Touch	Without function
	ON			

13.2.2 Status LEDs

The status of the respective LEDs at the HMI devices indicates the activity of the corresponding data lines.

These LEDs are located underneath the additional back lid that covers the interface circuit board. This additional back lid needs to be removed in order to see these LEDs.

	<p>In hazardous areas the HMI device must not be operated without the housing lid !</p> <p>The status LEDs can therefore only be observed at the first start-up or in safe areas.</p>
---	---

13.2.2.1 LEDs

Definition	Colour	Name	Description
LD5	green	COM1 TxD	Activity on COM1: sending, LED flashing
LD8	yellow	COM1 RxD	Activity on COM1: receiving, LED flashing
LD7	green	COM2 TxD	Activity on COM2: sending, LED flashing
LD6	yellow	COM2 RxD	Activity on COM2: receiving, LED flashing
LD14	yellow	LINK ACT	Ethernet link established, LED always on Activity on Ethernet link, LED flashing
LD15	green	HD	Access to system disk (Solid State, HDD), LED flashing (only for ET-4x6-A-* devices)

Back view of ET-xx6-A-* device:

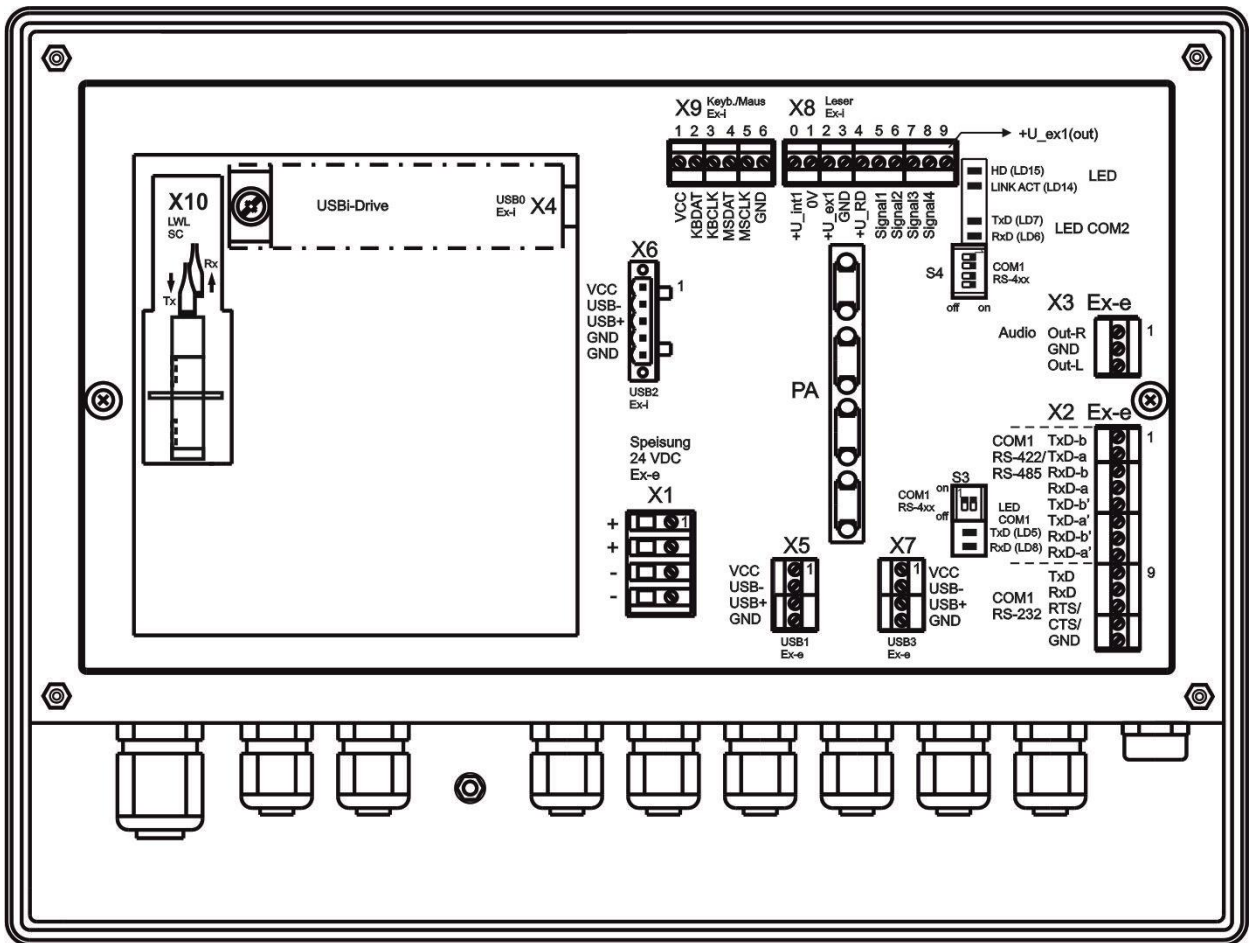

LED section at ET-xx6-A-* device:

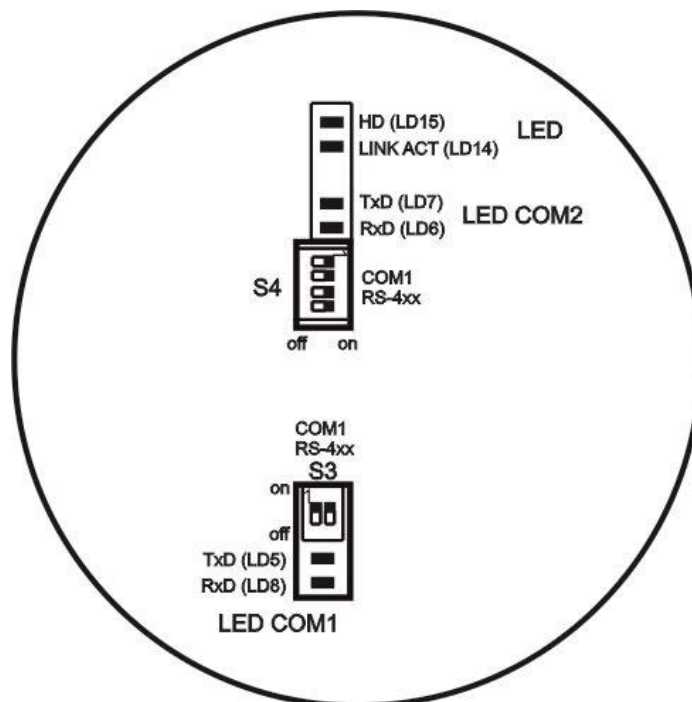

13.3 Connection of Readers

Readers with a serial RS-232 interface can be connected to the HMI devices. For this, the HMI device had to be fitted with a corresponding module for reader devices (see type code) or the power supply VM125-ex must be used.

! ATTENTION	Please note that the Ex-connection values of the reader must match the safety-relevant values of the interface !
--------------------	--

DOCUMENTATION	For the exact wiring diagram of each individual reader type, please refer to the actual reader documentation.
----------------------	---

HMI devices of the Panel PC and Thin Client series require an additional software (keyboard wedge) to transfer the data from the reader into the required application. This software is **NOT** part of the delivery !

13.3.1 Type RSi1 connection version 1

With the RSi1 connection version, the reader is supplied with power via the HMI device. In version 1, a maximum of 5.36 V and 220 mA are available for the reader.

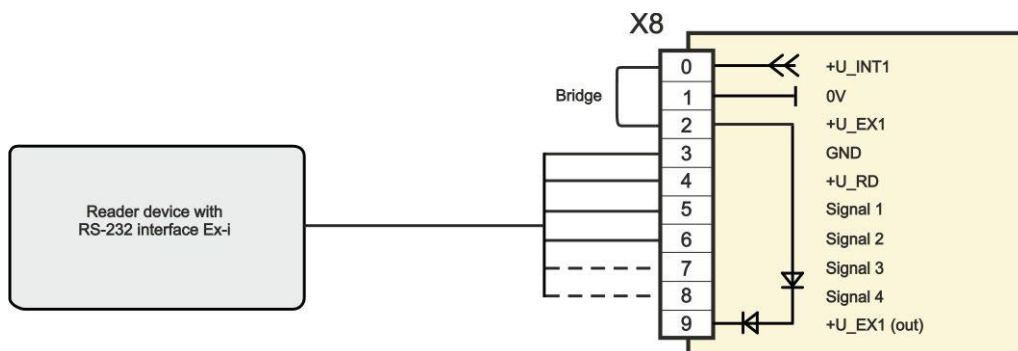

13.3.2 Type RSi1 connection version 2

In version 2, a maximum of 10.4 V and 220 mA are available for the reader.

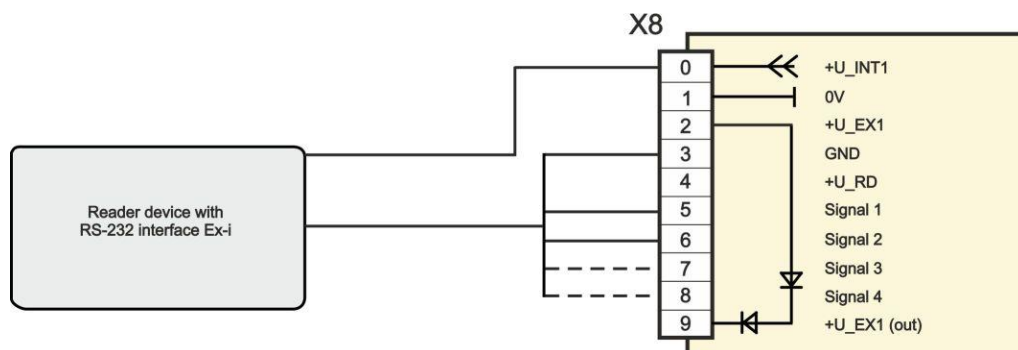

14 Maintenance, service

! NOTICE

Associated equipment is subject to maintenance, service and testing according to guidelines 1999/92/EC, IEC/EN 60079-14, -17, -19 and BetrSichVer (Betriebssicherheitsverordnung - Occupational Safety and Health) !

Because the transmission of the devices remains reliable and stable over long periods of time, regular adjustments are not required.

The following principles apply to repairs *, spare parts purchase* or exchange of parts * (where this can be done by the user !):

- Only original parts provided by the manufacturer must be used.
- Fuses may only be replaced by equivalent fuse types.

DOCUMENTATION

* Please also note [section Troubleshooting](#) !

The ET-xx6-A-* series HMI devices are maintenance-free across their entire lifespan.

System maintenance should focus on the following:

- a. Seal wear
- b. Display damage
- c. All screws are tightened fast
- d. All cables and lines are properly connected and undamaged

! CAUTION

If the device in its factory state is damaged or altered in any way, decommission it immediately and contact the manufacturer !

14.1 Damaged sealing

! NOTICE

If a defective seal is found on a device that has been returned to the manufacturer, an agreement is made with the customer as to whether it should be repaired (replaced).

If this exchange is not necessary, the option "No hazloc approved panel mount" is marked on the device by the manufacturer.

The device is only approved for installation inside an Ex e or Ex tb enclosure if no "No hazloc approved panel mount" option is indicated on the device. If the "No hazloc approved panel mount" option is indicated on the device, certification according to NEC / CEC is no longer possible or becomes void !

14.2 Servicing

In accordance with IEC/EN 60079-19 and IEC/EN 60079-17, operators of electric plants in hazardous areas are obliged to have them serviced by qualified electricians.

14.3 Saving data with ET-3x6-A-*

All online data is stored on the internal flash card and are therefore also available after the device has been switched off for a long time.

According to the current state-of-the-art the flash cards retain stored data for about 10 years.

14.4 Time function

Does not apply to ET-5x6-A-*:

When the ET-3x6-A-* and ET-4x6-A-* HMI devices are switched off, their clock function is maintained by a battery and a capacitor. As long as the battery is intact, the clock function is maintained. Once the battery fails, the capacitor takes over and maintains the clock function for about four days. If the HMI device is switched on after a longer interval than that, the time and date have to be re-set manually or via a connected system.

15 Troubleshooting

 NOTICE	Devices operated in hazardous areas must not be modified. Repairs may only be carried out by qualified, authorized staff specially trained for this purpose.
	Repairs may only be carried out by specially trained staff who are familiar with all basic conditions of the applicable user regulations and – if requested – have been authorized by the manufacturer.

16 Disposal / Restricted substances

Disposal of old electric and electronic devices, packaging and used parts is subject to regulations valid in whichever country the device has been installed.

For countries under the jurisdiction of the EU the corresponding WEEE directive applies.

The devices are classified according to the table below:

Directive	WEEE II directive 2012/19/EU
Valid	from 2018-08-15
Category	SG2 screens, monitors, devices with monitors >100 cm ²

R. STAHL HMI Systems GmbH meets the requirements of directive 2012/19/EU (WEEE) and is registered under the number DE 15180083.

We shall take back our devices according to our General Terms and Conditions.

16.1 Declaration of substances and restricted substances

The present declaration is based on the procedure described in the international standard and directives as listed in the table below:

- IEC 62474 : 2018 (DIN EN IEC 62474 : 2019-09)
- (EG) Nr. 1907/2006 (REACH)
- Directive 2011/65/EU (RoHS)
- Resolution MEPC.269(68) "International Maritime Organization" (IMO); particularly "2015 Guidelines for the Development of the Inventory of the Hazardous Materials" (IHM)

16.1.1 Declarable substance groups

ECHA Legal Entity UUID of the R. STAHL HMI Systems GmbH:
ECHA-a4dd94d5-bcd2-405d-8fdd-010a535d7e87

SCIP number: fa5bf564-360c-465f-973e-1c33b9e27517

Component	Name	Mass (g)	Declarable Substance Groups and Substances (IEC 62474 database)	CAS No.	Mass %	Exemption (acc. to directive)
BR2330	Lithium coin cell ATOM boards	3.2	Ethylene glycol dimethyl ether (1,2-Dimethoxyethan / EGDME)	110-71-4	3.8100	-

16.1.2 RoHS directive 2011/65/EC

The devices meet the requirements of RoHS Directive 2011/65/EU.

16.1.3 IMO Resolution MEPC.269(68)

The devices meet the requirements of the MEPC.269(68) Resolution of the "International Maritime Organization" (IMO), in particular the "2015 Guidelines for the Development of the Inventory of the Hazardous Materials" (IHM).

16.1.4 China RoHS labelling

The part of all toxic or hazardous substance contained in the homogeneous materials of the HMI devices is below the limit requirements in SJ/T11363-2006.

17 General information

17.1 Touch driver

 NOTICE	<p>The UPDD touch driver is copyrighted licensed software supplied strictly for use with original R. STAHL HMI Systems GmbH touch systems and under no circumstances should this driver be downloaded or used on any other equipment !</p>
--	--

17.2 Keyboard features

 NOTICE	<p>The information according the keyboard features applies ONLY to the 300 and 400 SERIES of HMI devices, and NOT to the 500 SERIES.</p> <p>Pressing two keys at once (e.g. F1 + F7) is not supported by the HMI devices ! In such a case, the system considers the key that was pressed first as "active" and implements the associated functions and / or key bit functions ! The key pressed second is ignored.</p> <p>The key kombination of Ctrl + Alt + Del can NOT be realized via the virtual keyboard ! For this you must use an external connected keyboard !</p> <p>If you like to have a simulation from the key kombination of Ctrl + Alt + Del via the F-keys of the HMI device, it must be stated when ordering, as it can only be done by the manufacturer before delivery.</p> <p>Pressing the keys F1, F2 and F8 at the same time, if the F-key simulation is activated, it has the same effect as pressing Ctrl + Alt + Del !</p> <p>ET-306-A-* only: Pressing the S1 – S10 softkeys on the ET-306-A-* has the same effect as pressing the numerical keys (num lock) 0 – 9.</p> <p>At the image Movicon CE only the S1 – S10 softkeys are allocated as the combination of Shift + F1 – Shift + F10 keys function.</p> <p>ET-406-A-* only: Pressing the S1 – S10 softkeys on the ET-406-A-* has the same effect as pressing the combination of Shift + F1 – Shift + F10 keys function.</p>
--	--

17.3 ET-4x6-A-* (Panel PC)

17.3.1 Up to Windows 7 operating systems

17.3.1.1 Licensing issues

The Panel PC devices SERIES 400 which are pre-installed with a Windows operating system are equipped with a license sticker.

The license sticker is affixed on the back of the HMI device, next to the type plate.

Please note that according to the license issued for Windows the application of this system as an Office PC is not permitted.

 DOCUMENTATION	Please also note the information on the licensing stipulations for Windows operating systems contained in the "TechNote Windows Operating Systems" file located on the CD / DVD / USB stick, which is part of the delivery.
---	---

17.3.1.2 Note on Windows Embedded operating systems

When using the Windows Embedded operating systems (XP or Windows Standard 2009 / 7) on the Panel PC devices SERIES 400, the C:\ system drive can be protected from unauthorised writing (EWF).

 NOTICE	This is NOT the case with other Windows operating systems !
--	--

 ATTENTION	R. STAHL HMI Systems GmbH recommends you leave the write protection filter on at all times !
---	--

 DOCUMENTATION	For further information regarding this Write Protection (EWF), please refer to the OpenHMI_help_en.chm help file in the "STAHL" folder on the device or on the CD / DVD / USB stick that is included in the delivery.
---	---

17.3.2 Windows® 10 IoT Enterprise 2019 LTSC operating system

The operating system is based on Windows 10 for PC platforms with 64 bit x86 processors. For the LTSC (Long Term Servicing Channel) versions, Microsoft guarantees 10 years of security updates and new builds with feature updates only every 2-3 years, with these being optional. The LTSC versions are ideal for industrial applications and feature additional security components such as write filters (UWF) and HORM (start of a system snapshot from the RAM plus write protection).

From 2016 LTSB onwards, Microsoft has tied its licensing model to the processor performance:

ENTRY	for AMD® GX and ATOM™
VALUE	for Intel® Core i5™
HIGH	for Intel® Core i7™

The Panel PC SERIES 400 HMI devices with Windows 10 IoT Enterprise 2019 LTSC operating systems have the license provided as part of the image, with the corresponding label affixed to the back of the device. When delivered, the devices have already been registered and activated.

The EOL (End of Life) date for Windows 10 IoT Enterprise 2019 LTSC for support and updates has been set by Microsoft to 09.01.2029.

17.3.2.1 Recovery

 NOTICE	<p>If a Panel PC is reset to the factory state (recovered) it will remain registered but will have to be reactivated ! This requires an active internet connection to a Microsoft server !</p>
---	--

17.3.2.2 Company-specific Windows installations

 NOTICE	<p>The Windows 10 IoT license key is tied to STAHL images ! The installation of own Windows 10 IoT operating systems requires a separate license key !</p> <p>All necessary drivers are provided by R.STAHL HMI Systems GmbH. Please contact our Support department.</p>
---	--

17.3.3 Initial start-up

When the device is started for the first time, the Windows installation assistant starts where users have to select certain settings.
Please follow the instructions of the installation assistant.

17.3.4 Recovery Stick

 NOTICE	<p>To restore your Panel PC device to its original state you will need a Recovery Stick, which is available as an optional extra. This recovery stick (USB-drive, also available intrinsically safe) contains the factory image, with which the system can be restored to delivery status within a very short time.</p> <p>Please note that you can restore the HMI devices to their original state only with the aid of the Recovery Stick</p> <p>As an option, the recovery stick can also contain a backup software, with which you can back up your own device configuration.</p>
---	---

17.3.5 Back-up

 NOTICE	<p>Please note that it is the sole responsibility of the operator to generate a back-up of the HMI devices and their overall function.</p> <p>We strongly recommend such a back-up to be stored on an external storage medium or on the company network.</p>
---	--

17.3.6 Switching off / closing down

! NOTICE

The Microsoft Windows operating system stores key data in the main memory, regardless of the application, and has to store this data on the hard disk before the HMI device is switched off.

! ATTENTION

It is therefore important for the safe and correct operation that the HMI device is closed down properly (see illustration below) and **NOT** simply switched off. Otherwise the existing image of the device may be damaged, rendering the HMI device non-functioning.

After the data has been stored, Windows informs the user that the HMI device can now be switched off.

! ATTENTION

Only switch off the HMI device once you have received this message !

17.3.7 Data loss

! NOTICE

In the case of applications that require constant writing into memory, R. STAHL HMI systems recommends you use external storage media (USB sticks, network servers) for these write processes.

! ATTENTION

Try and avoid cyclical writes (log files, databases, etc.) to the SSD ! The endurance of an SSD depends on the number of write cycles (TBW / terabytes written). Writing to the SSD with a simultaneous drop in voltage is most likely going to result in data loss !

17.4 Defective pixels

As a result of the manufacturing process (production tolerances and errors) for the displays they may be delivered with defective pixels. Provided they are within the range of the specification below these potential defective pixels are not a display or HMI error or defect.

17.4.1 Terminology

Defective pixels Pixels or sub-pixels that do not perform as expected and are either always on or always off

Pixel Image point on the display consisting of 3 sub-pixels in the basic colours red, green and blue



Dot Sub-pixel in the basic colour red, green or blue



Bright Sub-pixel (dot) to which light is passing through, creating a bright dot that is on

Dark Sub-pixel (dot) to which no light is passing through, creating a dark dot that is off

adjacent dots dots positioned next to one another, horizontally, vertically or diagonally, bright or dark (e.g. the following pattern and sub-pixels)

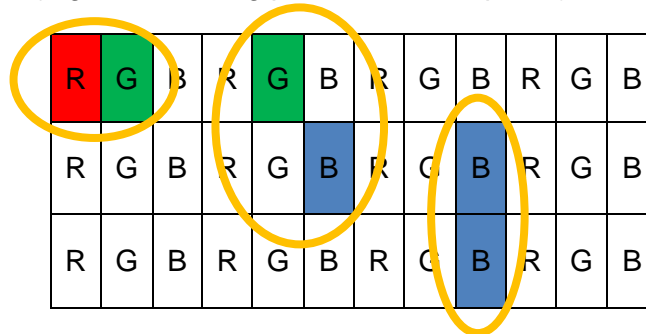

Distance between Dots Definition of distance between two defective dots horizontal, vertical or diagonal, bright or dark (e.g. the following pattern and sub-pixels)

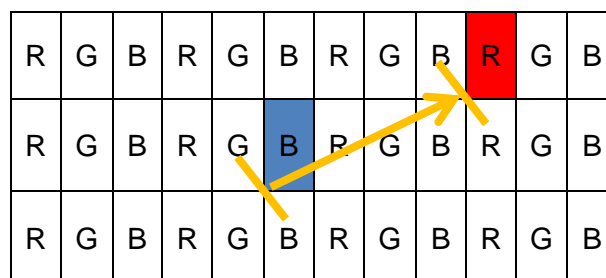

17.4.2 Display specification

Type of defect / description	max. number of permitted defects		
	10.4" display	15" display	19" display
Linear defect (horizontal, vertical)	not permitted		
Defective pixels			
bright dots	≤ 3	≤ 2	≤ 2
dark dots	≤ 4	≤ 3	≤ 5
total number of dots	≤ 5	≤ 5	≤ 5
adjacent dots			
2 bright dots	not permitted	≤ 1 pair	≤ 1 pair
more than 3 bright dots	not permitted		
2 dark dots	≤ 1 pair	≤ 1 pair	≤ 2 pairs
more than 3 dark dots	not permitted		
Distance between the dots			
between 2 bright dots	not permitted	≥ 15 mm	≥ 15 mm
between 2 dark dots	≤ 5 mm	≥ 15 mm	≥ 15 mm
between 1 bright and 1 dark dot	≤ 15 mm	≥ 15 mm	≥ 15 mm
ND filter for mura effects, bright and dark dots	view with 6% filter	view with 5% filter	view with 5% filter

18 Optical acceptance of surfaces

This section covers the acceptance criteria applicable to the minimum requirements for surfaces of devices and components.

The values for imperfection types listed under "tolerance limits" do not constitute a defect or an imperfection of the device or component and must therefore be tolerated.

18.1 Optical acceptance glass

Imperfection type	Criterion	Tolerance limits
Total imperfections	Number	Max. 3
Cleanness of glass surface	Clearly visible dirt	not permitted
Edge crack / incipient crack	visible	not permitted
Scratches	Width	up to 0.16 mm
	Length	up to 40 mm
	Cumulative length of all scratches	max. 40 mm
	Long side of glass < 300 mm, distance > 70 mm	
	Number	2
	Long side of glass 300 - 600 mm, distance > 70 mm	
Number		3
Hairline scratches / scraper damage	Width	max. 0.05 mm
	Length	max. 40 mm
Large point defects	Size	max. 0.4 mm ²
	Number	2
Small point defects	Size	max. 0.16 - 0.4 mm ²
	Number	5
Permitted point defects	Size	< 0.16 mm ² , provided there is no cluster ***
Interference points	Ø < 0.2 mm	permitted
	0.2 mm < Ø ≤ 0.6 mm	permitted provided there is no cluster ***
	0.6 mm < Ø ≤ 1.3 mm	5
	1.3 mm < Ø ≤ 2.0 mm	2
	Ø > 2.0 mm	not permitted
Inhomogeneity *	minor colour variations	permitted
White haze **	only visible in reflection	permitted
	not visible when device is in operating position.	permitted

	* in the case of coated float glass, inhomogeneity in the form of minor colour variations can occur and cannot be prevented by any technical means
	** large, cloudy blemish, can be more pronounced towards the centre of the glass, but can also affect larger parts of the glass.
	*** a cluster is an accumulation of more than 7 disregarded, permitted imperfections that occur within an inspected area of a diameter of 40 mm.

18.2 Optical acceptance printing

Description	Tolerance limits
Labelling	Clearly legible, minimum stroke weight 0.3 mm
Characters	clearly legible
Lines and symbols	Gaps not permitted
Ink coverage	sufficient if underlying layers and structures not visible
Acutance	+/- 0.15 mm
Edge blurring	+/- 0.15 mm
Print overlap	possible colour variations in the overlap area are permitted
Variations of stroke weight	10 %
Within a shaping print	"Fine" as specified in DIN ISO 2768-1 General tolerance class
Between shaping prints	< 400 mm +/- 0.3 mm ≥ 400 mm +/- 0.5 mm

Imperfection type	Criterion	Tolerance limits
Dirt and dust particle inclusions, stains, fluff,	Size	max. 0.16 mm ²
	Size for weak colour contrast	max. 0.25 mm ²
	Number / 100 cm ²	1
	Minimum distance	80 mm
	Lower limit	0.063 mm ²





18.3 Optical acceptance, other surfaces

Definitions

Scratch	straight or curved / wavy surface damage
Dents / dings	plastic deformation inwards or outwards
Scuff mark without dent	"punch mark"-type depression

Surface categories

If not specified otherwise in the drawing, the following applies:

A surface	Surface is frequently viewed, typically the front plate. Surface is in customer's field of vision	
	Colour code	
B surface	Surface is occasionally viewed, typically the sides of the device	
	Colour code	
C surface	Surface is rarely viewed, typically the back or bottom of device	
	Colour code	
D surface	Surface is never viewed, typically the inside of the device	
	Colour code	

Accessories such as stand, wall bracket etc. are termed C surfaces



Imperfection type	A surface	B surface	C surface	D surface
Scratches	max. 1 per side	max. 2 per side	1x up to 100 mm with the grain	permitted
	0.05 – 0.1 mm wide and max. 10 mm long	0.05 – 0.1 mm wide and max. 10 mm long		
	or	or	and	
	0.01 – 0.05 mm wide and max. 40 mm long	0.01 – 0.05 mm wide and max. 40 mm long	3x up to 15 mm against the grain	
	only with the grain	only with the grain	1x up to 30 mm against the grain	
Gouges, depressions (punch-mark-type depression)	not permitted	not permitted	max. 2 per side max. 0.3 mm wide max. 3 mm long	permitted
Dents / cavities	not permitted	not permitted	not permitted	not permitted
welding flaws	not permitted	not permitted	not permitted	not permitted
Chatter marks	not permitted	not permitted	not permitted	not permitted
Material flaws	not permitted	not permitted	not permitted	not permitted
Orange peel: surface not homogeneous	not permitted	not permitted	not permitted	permitted

19 Certification Drawing NEC

Installation with enclosure

Hazardous (Classified) Location:

Class I, Div. 2, Groups A, B, C and D;
 Class II, Div. 2, Groups F and G;
 Class III Hazardous Locations;
 Class I, Zone 2, Group IIC
 Temperature Code T4

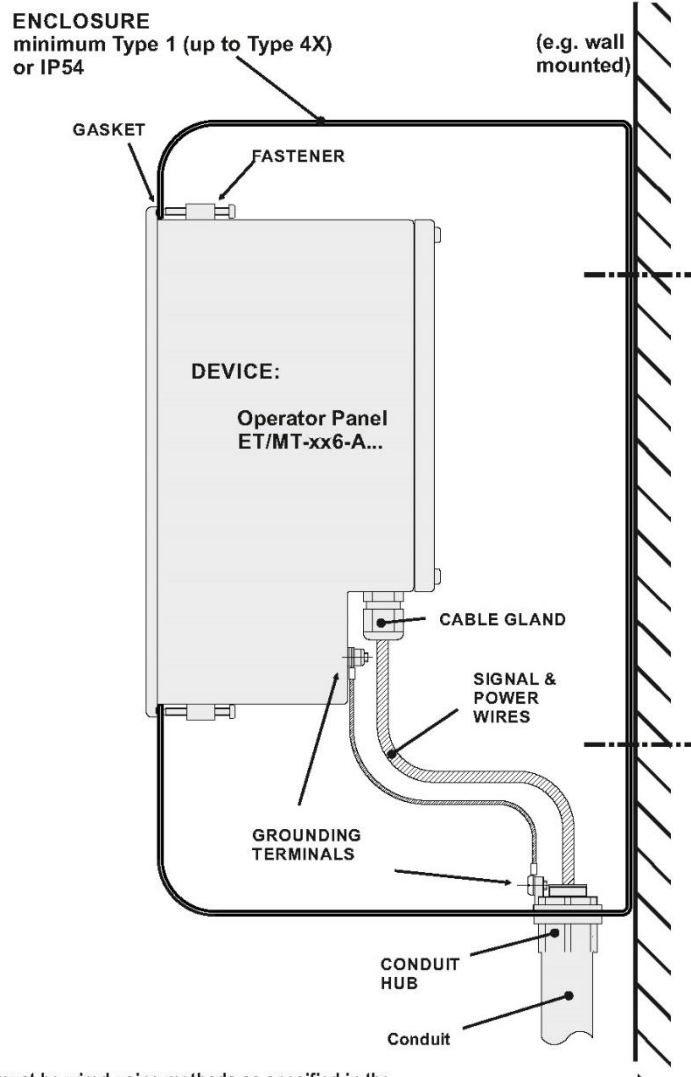

All circuits must be wired using methods as specified in the appropriate articles of the National Electric Code NFPA 70 for installation within the United States!

			2017	Date	Name	Control drawing		Scale	
			Drawn by	April 28	Bertges	Operator Panels Type: ET- / MT-xx6-A Installation with Enclosure		not to scale	
			Checked	May 3	Jung			Sheet	
			 R. STAHL HMI Systems GmbH Cologne / Germany www.stahl-hmi.de			Drawing number		1 of 1	
						File name		2017 17 54 0	Agency
Index	Date	Name					ET-MT-xx6-A_Installation_201717540-20170428.cdr	UL	A4

20 Control Drawing

20.1 NEC

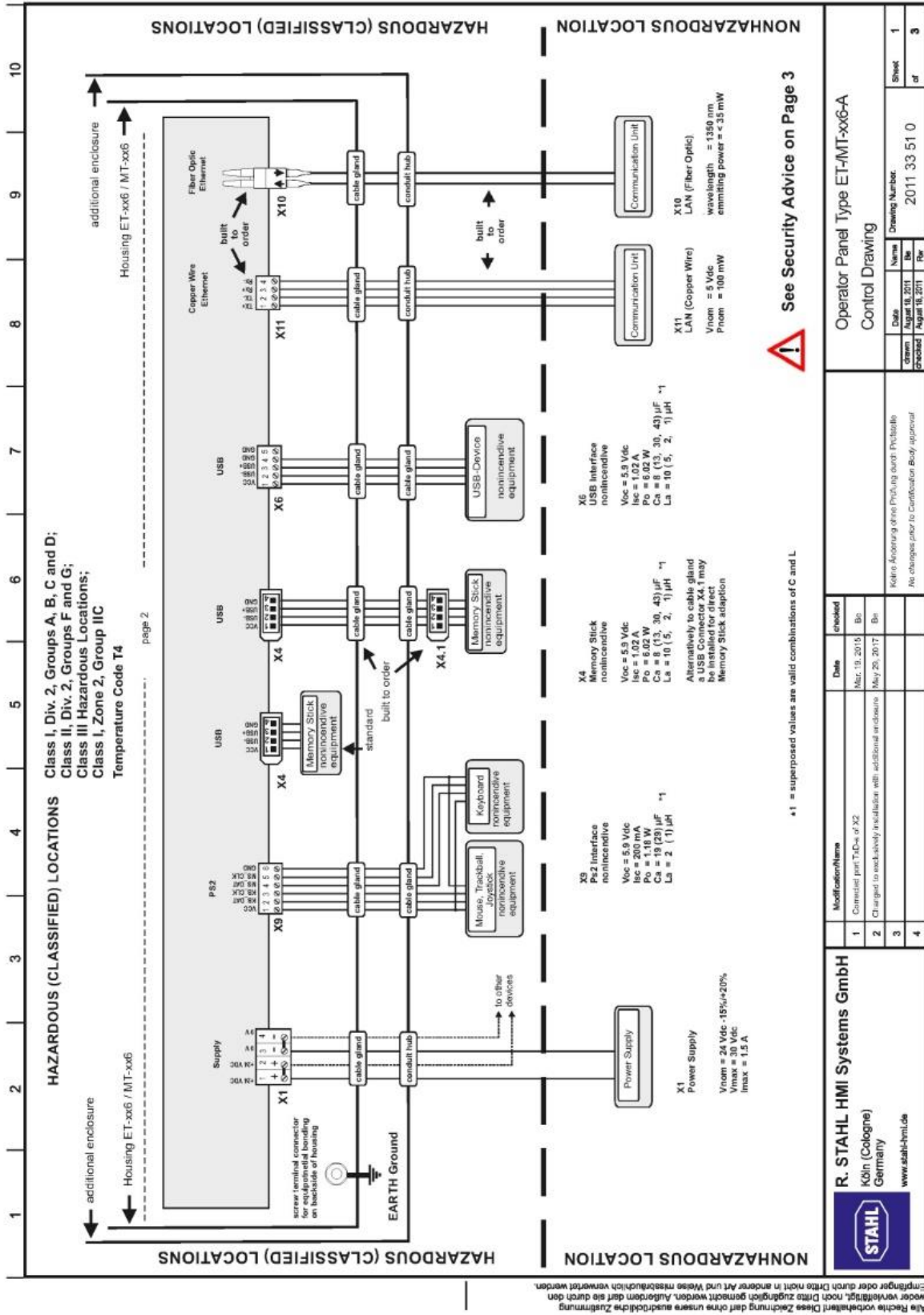

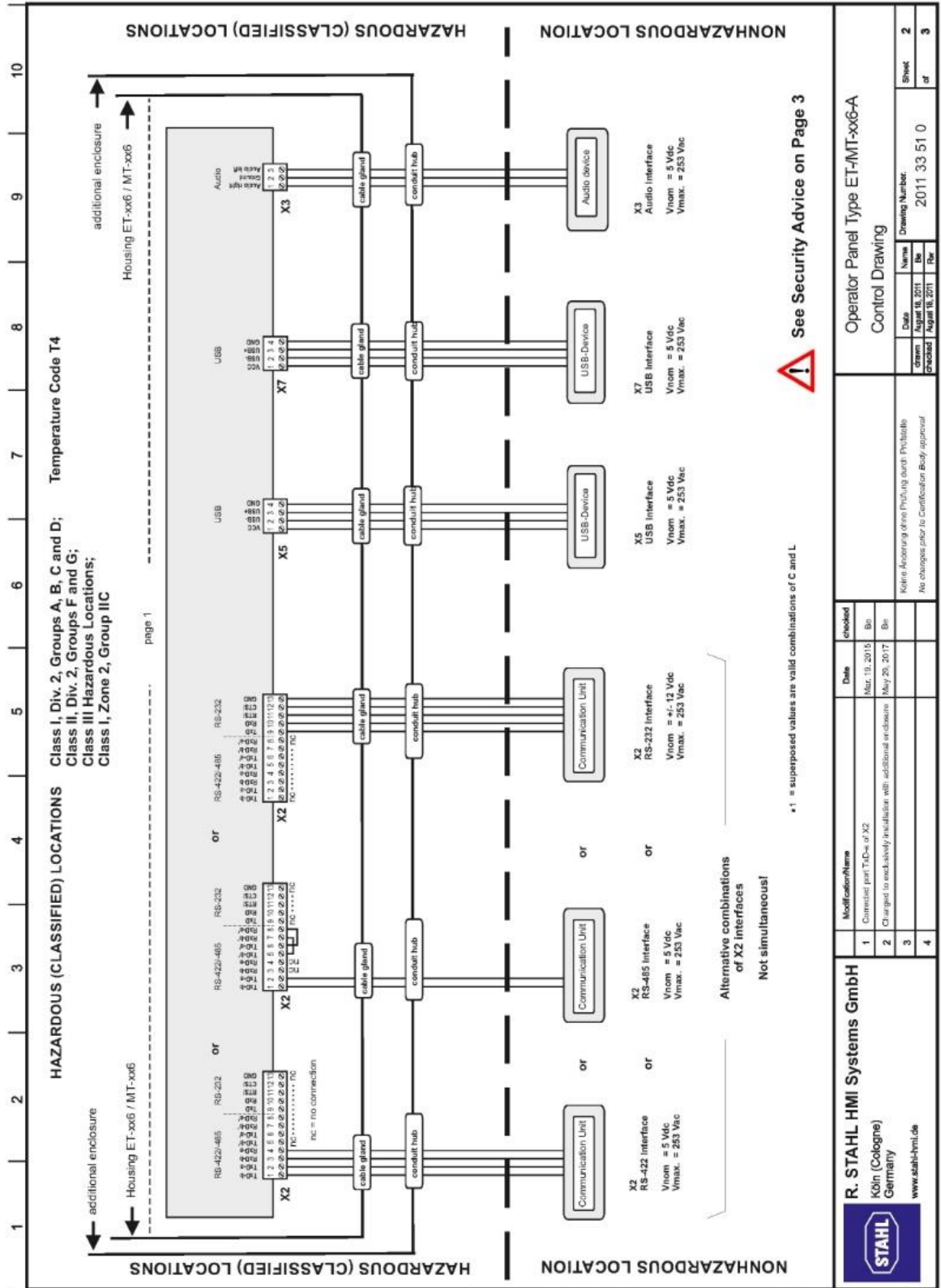

See Security Advice on Page 3

		R. STAHL HMI Systems GmbH Köln (Cologne) Germany www.stahl-hmi.de		Operator Panel Type ET-MT-xx6-A Control Drawing		Drawing Number: 2011 33 51 0		Sheet 2 of 3	
Modification Name 1 Corrected part Table of X2		Date Mar. 19, 2015 Bn		Status Drawn August 18, 2011 Checked August 18, 2011 Rvw		Date August 18, 2011 Bn		Sheet 2 of 3	
2 Changed to rock-savely insulation with additional enclosure		May 29, 2017 Bn		Kein Anbringen eines Prüfling durch Prüfböde No changes prior to Certification Body approval					
3									
4									

12345678910

Security Advice

1. No revision to drawing prior to certification body.
2. The Associated Apparatus must be NRTL approved.
3. Manufacturer's installation drawing must be followed when installing associated apparatus.
4. Interconnection of nonincendive equipment apparatus with associated apparatus is allowed when the following is true:

nonincendive Equipment Associated Apparatus

$V_{max} \geq V_{oc}$ or U_o

$I_{max} \geq I_{sc}$ or I_o

$P_i \geq P_o$

$C_i + C_{cable} \leq C_a$ (or C_o)

$L_i + L_{cable} \leq L_a$ (or L_o)

WARNING:

- Substitution of components may impair Safety.
- To prevent ignition of flammable or combustible atmospheres disconnect power and wait a minimum of 60s before servicing.

The ET-/MT-xx6 operator interfaces and connected devices must be integrated in the same system of potential equalization.
As an alternative to this, only devices hat are isolated from earth potential may be connected.

All circuits must be wired using

- Class I, Div. 2 methods as specified in Article 501.10(B);
- Class II, Div. 2 methods as specified in Article 502.10(B);
- Class III, Div. 1 methods as specified in Article 503.10(A);
- Class III, Div. 2 methods as specified in Article 503.10(B) with ref. to Article 503.10(A);

of the National Electric Code NFPA 70 for installation within the United States

Calculation of cable length

- 1.) Determination of maximum possible capacitance of cable:
 $C_{max} = C_a - C_i$ (associated Apparatus)
 Determination of maximum possible inductance of cable:
 $L_{max} = L_a - L_i$ (associated Apparatus)
- 2.) Determination of maximum possible cable length by capacitance and inductance of cable:
 $length\ C = C_{max} / C_{cable}$ (*)
 $length\ L = L_{max} / L_{cable}$ (*)
- 3.) Determination of maximum length of cable:
 $length\ C$ or $length\ L$, whatever is less.

(*) when cable parameters are unknown, the following values may be used:
 $C_{cable} = 60\ pF/ft.$ (200 pF/m)
 $L_{cable} = 0.2\ \mu H/ft.$ (0.66 $\mu H/m$)

Alle Rechte vorbehalten! Diese Zeichnung darf ohne unsere ausdrückliche Zustimmung
Empfänger oder durch Dritte nicht in anderer Art und Weise massstäblich verwendet werden.
wieder veröffentlicht, noch Dritten zugänglich gemacht werden, ausserdem darf sie durch den

No.	Modification Name	Date	Checked	Name
1	Completed part T, D, e of X2	Mar. 19, 2015	Bis	
2	Changed to rock-silvery insulator with additional enclosure	May 29, 2017	Bis	
3				
4				

R. STAHL HMI Systems GmbH
Köln (Cologne)
Germany
www.stahl-hmi.de

Operator Panel Type ET-/MT-xx6-A
Control Drawing

Drawn	August 18, 2011	Name	Bis	Drawing Number	2011 33 51 0
Checked	August 18, 2011				

Köln-Anerkennung der Prüf- und Zeichnung durch: P. Hitzelsch
No changes prior to Certification Body approval

Sheet	3
of	3

20.2 CE-Code

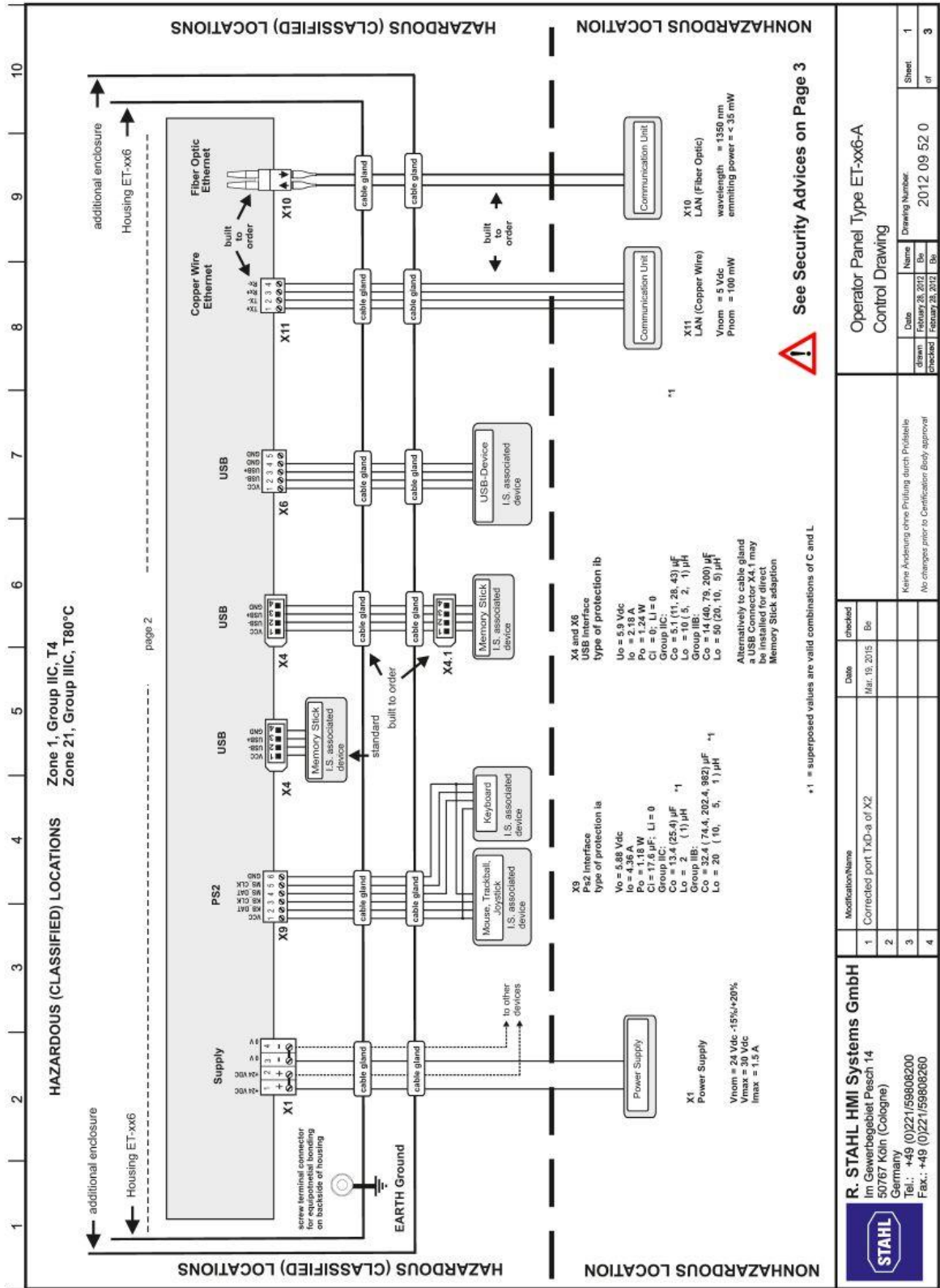

Ale Rechte vorbehalten! Diese Zeichnung darf ohne unsere ausdrückliche Zustimmung weiterverbreitet, noch Dritten zugänglich gemacht werden. Außerdem darf sie durch den Empfänger oder durch Dritte nicht in anderer Art und Weise missbräuchlich verwendet werden.

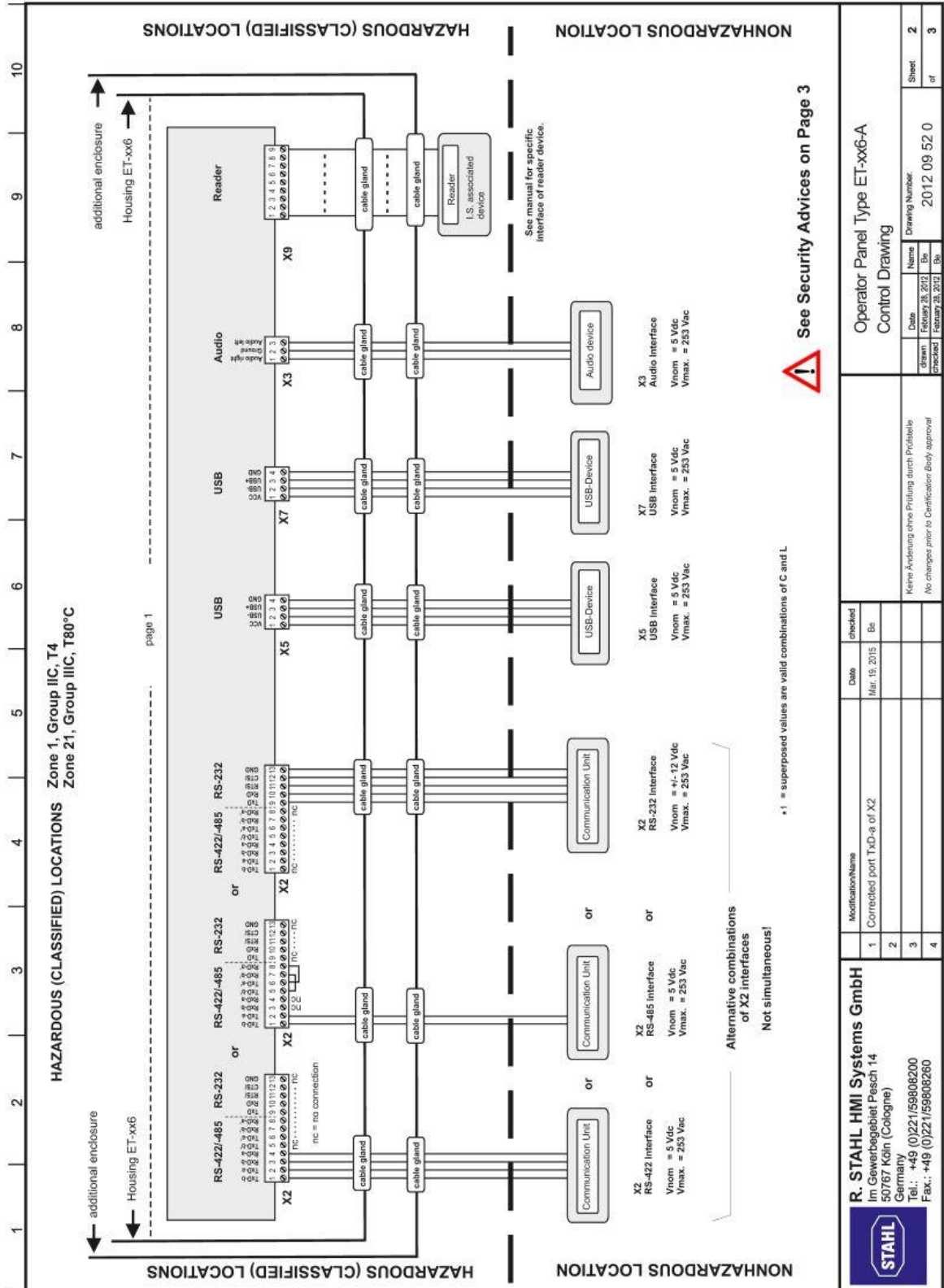

Alle Rechte vorbehalten! Diese Zeichnung darf ohne unsere ausdrückliche Zustimmung
 wiederverbreitet, kopiert, nachgedruckt, verändert, vervielfältigt oder in sonstiger Weise
 missbräuchlich verwendet werden.

		R. STAHL HMI Systems GmbH Im Gewerbegebiet Pesch 14 50767 Köln (Cologne) Germany Tel.: +49 (0)221/59808200 Fax.: +49 (0)221/59808260		Modification/Name 1 Corrected port TXD-a of X2 2 3 4		Date Mar. 19, 2015 By		checked By		Operator Panel Type ET-xx6-A Control Drawing	
Keine Änderung ohne Prüfung durch ProSieble No changes prior to Certification Body approval						Name February 28, 2012 February 28, 2012 By		Drawing Number: 2012.09.52.0		Sheet 2 of 3	

12345678910

Security Advices

1. No revision to drawing prior to certification body.
2. The Associated Apparatus must be approved by a NRTL.
3. Manufacturer's installation drawing must be followed when installing associated apparatus.
4. Interconnection of equipment apparatus type of protection „I.S.“ with associated apparatus is allowed when the following is true:

I.S. Equipment	Associated Apparatus
Vmax	Uo
Imax	Io
Pi	Po
Ci + Ccable	Co
Li + Lcable	Lo

WARNING:

- Substitution of components may impair Safety.
- To prevent ignition of flammable or combustible atmospheres disconnect power and wait a minimum of 60s before servicing.

The ET-/MT-xx6 operator interfaces and connected devices must be integrated in the same system of potential equalization.
As an alternative to this, only devices hat are isolated from earth potential may be connected.

All circuits must be wired as specified in the Canadian Electric Code for installation within Canada.

Calculation of cable length

- 1.) Determination of maximum possible capacitance of cable:
 $C_{max} = C_o - C_i$ (associated Apparatus)
 Determination of maximum possible inductance of cable:
 $L_{max} = L_o - L_i$ (associated Apparatus)
- 2.) Determination of maximum possible cable length by capacitance and inductance of cable:
 $length\ C = C_{max}$
 C_{cable} (*1)
 $length\ L = L_{max}$
 L_{cable} (*1)
- 3.) Determination of maximum length of cable:
 $length\ C$ or $length\ L$, whatever is less.

(*1) when cable parameters are unknown, the following values may be used:
 $C_{cable} = 60\ pF/ft.$ (200 pF/m)
 $L_{cable} = 0.2\ \mu H/ft.$ (0.66 $\mu H/m$)

checked	Date	Modification/Name
1	Mar. 18, 2015	Corrected port TXD-a of X2
2		
3		
4		

R. STAHL HMI Systems GmbH		Operator Panel Type ET-xx6-A	
Im Gewerbegebiet Presch 14 50767 Köln (Cologne) Germany		Control Drawing	
Tel.: +49 (0)221/59808200		Date	Name
Fax.: +49 (0)221/59808260		checked	checked
		Date	Drawing Number
		February 23, 2012	2012.09.52.0
		By	3
		By	of
		By	3

Alle Rechte vorbehalten! Diese Zeichnung darf ohne unsere ausdrückliche Zustimmung Engländer oder durch Dritte nicht in anderer Art und Weise missbräuchlich verwendet werden.

21 Installation Instructions Requirements China

安装使用要求

Installation Instructions Requirements



认证编号

CN2020C2309-003906-1

Certification No.

本产品经认证符合 CNCA-C23-01: 2019《强制性产品认证实施规则 防爆电气》的要求。

The product(s) is verified and certified according to CNCA-C23-01: 2019 China Compulsory Certification Implementation Rule on Explosion Protected Electrical Product.

#	产品名称 Product 型号 Type	防爆标志 Ex Marking
1	防爆人机界面 ET-**6-A-* -***	Ex db eb ia ib mb [ia ib Gb] IIC T4 Gb Ex ia tb [ia ib Db] IIIC T80°C Db Ex db eb ia ib mb [ia ib op is Gb] IIC T4 Gb Ex ia tb [ia ib op is Db] IIIC T80°C Db

系列标准 Series standards	GB/T3836.1-2021, GB/T3836.3-2021, GB/T3836.4-2021, GB/T3836.7-2017, GB/T3836.31-2021
安全使用条件 Specific conditions of safety use:	<ul style="list-style-type: none"> - 人机操作界面设备前部安装的防眩光显示屏（类型代码含“SR”）以及其他型号的显示屏表面涂装了一层附加膜，只能用湿布清洁。 - 本产品认证不包括对光辐射“op is”标准的评价和试验。 - For ET - ** 6 - A - * - *SR* : The front of the operator interface equipped with a sunlight readable display(type code includes “SR”) may be cleaned with a damp cloth only. - The evaluation and test of the optical radiation "op is" standard are not included in the scope of this product certification.

R. STAHL HMI Systems GmbH

产品上的符合性标志:

Compliance marks on product:



中国强制性认证
China Compulsory Certification
CCC: 2020312309000285

德国制造 Made in Germany

Doc No.: OI_ET-xx6-A

Approved:

Date : 2023.03.20

22 Declarations of conformity

22.1 EU

EU-Konformitätserklärung
EU Declaration of Conformity
Déclaration de Conformité UE



R. STAHL HMI Systems GmbH • Adolf-Grimme-Allee 8 • 50829 Köln, Germany

erklärt in alleiniger Verantwortung, *declares in its sole responsibility, déclare sous sa seule responsabilité,*

dass das Produkt:

that the product:

que le produit:

Bedien- und Beobachtungsgeräte

Operating and Monitoring Devices

Consoles de commande et de visualisation

Typ(en), *type(s)*, *type(s)*:

EXICOM

ET-306-A-*.;** **ET-406-A-*.**;** **ET-506-A-*.**;**

ET-316-A-*.;** **ET-416-A-*.**;** **ET-516-A-*.**;**

ET-336-A-*.;** **ET-436-A-*.**;** **ET-536-A-*.****

ET-356-A-*.;** **ET-456-A-*.**;** **ET-556-A-*.****

* = Fx or Tx

** = HDn and/or SR and/or additional information (not ex-relevant)

mit den Anforderungen der folgenden Richtlinien und Normen übereinstimmt.

is in conformity with the requirements of the following directives and standards.

est conforme aux exigences des directives et des normes suivantes.

Richtlinie(n) / Directive(s) / Directive(s)		Norm(en) / Standard(s) / Norme(s)	
2014/34/EU	ATEX-Richtlinie	IEC 60079-0:2017	Das Produkt entspricht Anforderungen aus: <i>Product corresponds to requirements from:</i> <i>Produit correspond aux exigences:</i>
2014/34/EU	ATEX Directive	IEC 60079-1:2014	
2014/34/UE	Directive ATEX	IEC 60079-7:2017	
		IEC 60079-11:2011	
		IEC 60079-18:2018	
		IEC 60079-28:2015	
		IEC 60079-31:2013	
			EN IEC 60079-0:2018
			EN 60079-1:2014
			EN IEC 60079-7:2015 + A1:2018
			EN 60079-11:2012
			EN 60079-18:2015/A1:2017
			EN 60079-28:2015
			EN 60079-31:2014

Kennzeichnung, *marking, marquage:*

TypeTX:

II 2 (2) G Ex db eb ia ib mb [ja ib] IIC T4 Gb

II 2 (2) D Ex ia tb [ja ib] IIIC T80°C Db IP66



Type FX:

II 2 (2) G Ex db eb ia ib mb [ja ib op is] IIC T4 Gb

II 2 (2) D Ex ia tb [ja ib op is] IIIC T80°C Db IP66

CE 0158

EU-Baumusterprüfbescheinigung:

EU Type Examination Certificate:

Attestation d'examen UE de type:

TÜV 11 ATEX 7041 X

TÜV Rheinland Industrie Service GmbH (NB 0035)

Am grauen Stein, 51105 Köln (Cologne), Germany

2014/30/EU

EMV-Richtlinie

2014/30/EU

EMC Directive

2014/30/UE

Directive CEM

EN 61000-6-2:2005

EN 61000-6-4:2007 + A1:2011

EN 61326-1:2013

Produktnormen nach RoHS-Richtlinie (2011/65/EU):

Product standards according to RoHS Directive:

Normes des produit pour la Directive RoHS:

EN IEC 63000:2018

EU-Konformitätserklärung
EU Declaration of Conformity
Déclaration de Conformité UE



Für spezifische Merkmale und Bedingungen siehe Betriebsanleitung.
For specific characteristics and conditions see operating instructions.
Pour les caractéristiques et conditions spécifiques, voir le mode d'emploi.

Köln, 2020-04-26

Ort und Datum
Place and date
Lieu et date

i.V.





A. Jung
Director R&D

i.V.

N. Benighil
Head of Certification

22.2 CCC

22.2.1 English version

		CERTIFICATE FOR CHINA COMPULSORY PRODUCT CERTIFICATION	
No.: 2020312309000285			
Applicant	R. STAHL HMI Systems GmbH		
Address	Adolf-Grimme-Allee 8, 50829 Köln, Germany		
Manufacturer	R. STAHL HMI Systems GmbH		
Address	Adolf-Grimme-Allee 8, 50829 Köln, Germany		
Production Factory	R. STAHL HMI Systems GmbH		
Production Address	Adolf-Grimme-Allee 8, 50829 Köln, Germany		
Product	Operator Interface		
Model/Type	ET-**6-A-*.***		
Ex marking	See annex		
Reference Standards	GB/T 3836.1-2021, GB/T 3836.2-2021, GB/T 3836.3-2021, GB/T 3836.4-2021, GB/T 3836.9-2021, GB/T 3836.31-2021		
Certification mode	Type Test + Initial Factory Inspection + Post-Certification Surveillance		
The product(s) is verified and certified according to CNCA-C23-01: 2019 <i>China Compulsory Certification Implementation Rule on Explosion Protected Electrical Product</i> and CNEX-C2301-2019 <i>Guideline of China Compulsory Certification Implementation Rule on Explosion Protected Electrical Product</i> .			
See Annex for the detailed product information(7 pages)			
Initial issue date: 2020-09-02		Valid to: 2025-09-01	
Issued date: 2023-04-28			
The validity of this certificate is maintained through the regular supervision of the issuing authority during the validity period.			
Where any discrepancy arises between the English translation and the original Chinese version, the Chinese version shall prevail.			
			Director: 
Nanyang Explosion Protected Electrical Apparatus Research Institute Co.,Ltd.		 中国认可 产品 PRODUCT CNAS C208-P	
http://www.ccc-cnex.com ccc.china-ex.com		Add: No. 20, North Zhongjing Road, Nanyang, Henan, P. R. China P.C.: 473008 Tel: 0377-63239734 Email: ccc@cn-ex.com	

CN 0001894



CERTIFICATE FOR CHINA COMPULSORY PRODUCT CERTIFICATION (Annex)

No.: 2020312309000285

Page 1 of 7

Product information:

1. This certificate covers the following models:

- ET-**6-A-*.***

Type code:

ET	-	*	*	6	-	A	-	*	-	***
1		2	3	4		5		6		7
1	Device for zone 1 and 21									
2	Type	3=EAGLE(STAHL Operating System)								
	Code:	4=OPEN HMI(Windows, Linux OS)								
		5=REMOTE HMI(Windows remote operating system)								
3	Size Code:	0=10" VGA display								
		1=10" SVGA display								
		3=15" display								
		5=19" display								
4	Family code fixed to 6									
5	Revision 3									
6	FX=Fiber optic LAN									
	TX=Copper wire LAN									
7	*HDn*=equipped with hard disk drive(memory size n)									
	and or									
	SR=Sunlight Readable display									
	and or additional information(not relevant to Ex)									

Issued date: 2023-04-28

Director:



Nanyang Explosion Protected Electrical
Apparatus Research Institute Co.,Ltd.



http://www.ccc-cnex.com
ccc.china-ex.com

Add: No. 20, North Zhongjing Road, Nanyang, Henan, P. R. China P.C.: 473008
Tel: 0377-63239734 Email: ccc@cn-ex.com



CERTIFICATE FOR CHINA COMPULSORY PRODUCT CERTIFICATION (Annex)

No.: 2020312309000285

Page 2 of 7

Technical data:

Operating temperature $-30^{\circ}\text{C} \leq T_a \leq +55^{\circ}\text{C}$ at front of unit
range: $-20^{\circ}\text{C} \leq T_a \leq +55^{\circ}\text{C}$ at rear of unit

IP code pf enclosure IP66

Electrical data:

1) External, non-intrinsically safe circuit

Input voltage (X1):
Rated voltage 24 VDC (+20% /-15%)
max. voltage Um 30 VAC
Rated current 1.5 A

RS-422/-232 COM 1 (X2):
Rated voltage RS232: ± 12 VDC
RS422: 5 VDC
max. voltage Um 253 VAC

Audio out (X3):
Rated voltage 5 VDC
max. voltage Um 253 VAC

USB-1 (X5):
Rated voltage 5 VDC
max. voltage Um 253 VAC

USB-3 (X7):
Rated voltage 5 VDC
max. voltage Um 253 VAC

LAN (X11):
Rated voltage 5 VDC
max. voltage Um 30 VAC

Issued date: 2023-04-28

Director:



Nanyang Explosion Protected Electrical
Apparatus Research Institute Co.,Ltd.



<http://www.ccc-cnex.com>
ccc.china-ex.com

Add: No. 20, North Zhongjing Road, Nanyang, Henan, P. R. China
Tel: 0377-63239734

P.C.: 473008
Email: ccc@cn-ex.com



CERTIFICATE FOR CHINA COMPULSORY PRODUCT CERTIFICATION (Annex)

No.: 2020312309000285

Page 3 of 7

RS-422/-232 COM 2-3 (X22):
 Rated voltage RS232: ±12 VDC
 RS422: 5 VDC
 max. voltage Um 253 VAC

2) External intrinsically safe circuits

Superposed L and C values are allowed combinations, the results see the table bellow. C_o and L_o pairs directly above/underneath each other may be used.

If the operator interfaces are installed in Zone 21 the maximum values for L and C of Group IIB apply to the intrinsically safe circuits.

(1) USB-0 (X4) and USB-2 (X6)

U_o = 5.9 V

I_o = 2.69 A Summed current when all connections from USB-0 (USB- 2) are short-circuited to GND.

P_o = 6.02 W Power available when all connections from USB-0 (USB- 2) are short-circuited to GND.

Maximum values calculated with ispark, rectangular source for Zone 1 Group IIC:

Li = 0	mH	Lo = 0.01	0.005	0.002	0.001	mH
Ci = 0	µF	Co = 5.1	11	28	40	µF

Maximum values calculated with ispark, rectangular source for Zone 1 Group IIB:

Li = 0	mH	Lo = 0.05	0.02	0.01	0.005	mH
Ci = 0	µF	Co = 14	40	79	200	µF

(2) ET-Reader-2-RSi1 and RSi2(X8)

Reader-2-RSi1 module supply (internal UB_RDR output), terminal X8.0(bridged to X8.2)

U_o =10.4V I_o = 220m A P_o = 2.29 W

Maximum values calculated with ispark, rectangular source for Zone 1 Group IIC:

Issued date: 2023-04-28

Director:



Nanyang Explosion Protected Electrical
Apparatus Research Institute Co.,Ltd.



http://www.ccc-cnex.com
ccc.china-ex.com

Add: No. 20, North Zhongjing Road, Nanyang, Henan, P. R. China
Tel: 0377-63239734

P.C.: 473008
Email: ccc@cn-ex.com



CERTIFICATE FOR CHINA COMPULSORY PRODUCT CERTIFICATION
(Annex)

No.: 2020312309000285

Page 4 of 7

Li = 0 mH Lo = 0.01 mH
Ci = 1.72 μF Co = 0.8 μF

Remark: no values for IIB as connection to X8.2 are already permitted with level IIC parameters.

Reader -2-RSi1 module supply input , terminal X8.2(bridged to X8.0)

Ui = 12.4 V li = 220 mA Pi = =2.29W
Li = 0 mH Ci = 25 nF

Reader-2-RSi1 power supply for reader, terminals X8.3-4

Uo = 5.36 V lo = 220 mA Po = 1.18 W

Maximum values, rectangular source for Zone 1 Group IIC:

Li = 0 mH Lo = 0.002 0.001 mH
Ci = 5.3 μF Co = 40.7 59.7 μF

Maximum values, rectangular source for Zone 1 Group IIB:

Li = 0 mH Lo = 0.02 0.01 mH
Ci = 5.3 μF Co = 70.7 124.7 μF

Reader-2-Rsi1 and -Rsi2 signal input/output, terminals X8.5-8

Ui = 15 V Uo = 5.36 V
li = 500 mA lo = 46 mA
Pi = 2.5 W Po = 62 mW

Maximum values, linear source for Zone 1 Group IIC:

Li = 0 mH Lo = 0.002 mH
Ci = 0 μF Co = 46 μF

Maximum values, linear source for Zone 1 Group IIB:

Li = 0 mH Lo = 0.02 mH
Ci = 0 μF Co = 79 μF

(3) ET-Reader-2-WCR1 and WCR2 (X8)

Issued date: 2023-04-28

Director:



Nanyang Explosion Protected Electrical Apparatus Research Institute Co.,Ltd.



http://www.ccc-cnex.com
ccc.china-ex.com

Add: No. 20, North Zhongjing Road, Nanyang, Henan, P. R. China P.C.: 473008
Tel: 0377-63239734 Email: ccc@cn-ex.com



CERTIFICATE FOR CHINA COMPULSORY PRODUCT CERTIFICATION
(Annex)

No.: 2020312309000285

Page 5 of 7

Reader-2-WCR1 module supply (from external is-power supply) terminal X8.1 - 2
 $U_i = 11.4 \text{ V}$ $I_i = 200 \text{ mA}$ $P_i = 2.28 \text{ W}$
 $L_i = 0 \text{ mH}$ $C_i = 25 \text{ nF}$

Reader-2-WCR1 power supply for reader, terminals X8.3 - 4
 $U_o = 5.88 \text{ V}$ $I_o = 200 \text{ mA}$ $P_o = 1.18 \text{ W}$

Maximum values, rectangular source for Zone 1 Group IIC:
 $L_i = 0 \text{ mH}$ $L_o = 0.002 \text{ mH}$ 0.001 mH
 $C_i = 5.3 \text{ }\mu\text{F}$ $C_o = 27.7 \text{ }\mu\text{F}$ $37.7 \text{ }\mu\text{F}$

Maximum values, rectangular source for Zone 1 Group IIB:
 $L_i = 0 \text{ mH}$ $L_o = 0.02 \text{ mH}$ 0.01 mH
 $C_i = 5.3 \text{ }\mu\text{F}$ $C_o = 55.7 \text{ }\mu\text{F}$ $94.7 \text{ }\mu\text{F}$

Reader-2-WCR1 and -WCR2 signal input/output, X8.5-8
 $U_i = 15 \text{ V}$ $U_o = 5.88 \text{ V}$
 $I_i = 500 \text{ mA}$ $I_o = 51 \text{ mA}$
 $P_i = 2.5 \text{ W}$ $P_o = 75 \text{ mW}$

Maximum values, linear source for Zone 1 Group IIC:
 $L_i = 0 \text{ mH}$ $L_o = 0.002 \text{ mH}$
 $C_i = 0 \text{ }\mu\text{F}$ $C_o = 34 \text{ }\mu\text{F}$

Maximum values, linear source for Zone 1 Group IIB:
 $L_i = 0 \text{ mH}$ $L_o = 0.02 \text{ mH}$
 $C_i = 0 \text{ }\mu\text{F}$ $C_o = 63 \text{ }\mu\text{F}$

(4) Keyboard & Pointing device protection level "ib"(X9)
 $U_o = 5.88 \text{ V}$
 $I_o = 200 \text{ mA}$
 $P_o = 1.18 \text{ mW}$

Issued date: 2023-04-28

Director:



Nanyang Explosion Protected Electrical Apparatus Research Institute Co.,Ltd.



<http://www.ccc-cnex.com>
ccc.china-ex.com

Add: No. 20, North Zhongjing Road, Nanyang, Henan, P. R. China P.C.: 473008
 Tel: 0377-63239734 Email: ccc@cn-ex.com



CERTIFICATE FOR CHINA COMPULSORY PRODUCT CERTIFICATION
(Annex)

No.: 2020312309000285

Page 6 of 7

Maximum values, rectangular source for Zone 1 Group IIC:

Li = 0 mH Lo = 2 1 μH
Ci = 17.6 μF Co = 15.4 25.4 μF

Maximum values, rectangular source for Zone 1 Group IIB:

Li = 0 mH Lo = 100 50 20 10 μH
Ci = 17.6 μF Co = 10.4 20.4 43.4 82.4 μF

(5) Keyboard & Pointing device protection level "ia"(X9)

Uo = 5.88 V Io = 4.36 A Po = 1.18 W

Maximum values, rectangular source for Zone 1 Group IIC:

Li = 0 mH Lo = 2 1 μH
Ci = 17.6 μF Co = 13.4 25.4 μF

Maximum values, rectangular source for Zone 1 Group IIB:

Li = 0 mH Lo = 20 10 5 1 μH
Ci = 17.6 μF Co = 32.4 74.4 202.4 982 μF

3) External inherently safe optical interface X10

Wavelength = 1350 nm
Radiant power ≤ 35 mW

Ingress Protection: IP66

Ex marking:

ET-**6-A-TX-***:

Ex db eb ia ib mb [ia ib Gb]IIC T4 Gb, Ex ia tb [ia ib Db] IIIC T80°C Db

ET-**6-A-FX-***:

Ex db eb ia ib mb [ia ib op is Gb]IIC T4 Gb, Ex ia tb [ia ib op is Db] IIIC T80°C Db

- Producers should organize production in accordance with the technical documents approved by the certification body.

Issued date: 2023-04-28

Director:



Nanyang Explosion Protected Electrical Apparatus Research Institute Co.,Ltd.



http://www.ccc-cnex.com
ccc.china-ex.com

Add: No. 20, North Zhongjing Road, Nanyang, Henan, P. R. China P.C.: 473008
Tel: 0377-63239734 Email: ccc@cn-ex.com



CERTIFICATE FOR CHINA COMPULSORY PRODUCT CERTIFICATION
(Annex)

No.: 2020312309000285

Page 7 of 7

2. Specific conditions of safety use:

- For ET - ** 6 - A - * - *SR* : The front of the operator interface equipped with a sunlight readable display(type code includes "SR") may be cleaned with a damp cloth only.
- The evaluation and test of the optical radiation "op is" standard are not included in the scope of this product certification.
- Before application, CCC certified cable gland that suitable for the conditions of use and/or stopping plug shall be applied, and correctly installed.
- See instruction for other information.

3. Certificate related report(s):

- Type test report: CQST2005C017, CQST2005C017/01
- Factory inspection report: CN2023Q030119.

4. Certificate change information:

- 1st change on April 28, 2023: Updated the standards for certification.

Issued date: 2023-04-28

Director:



Nanyang Explosion Protected Electrical Apparatus Research Institute Co.,Ltd.



<http://www.ccc-cnex.com>
ccc.china-ex.com

Add: No. 20, North Zhongjing Road, Nanyang, Henan, P. R. China
Tel: 0377-63239734

P.C.: 473008
Email: ccc@cn-ex.com

22.2.2 Chinese version



中国国家强制性产品认证证书

编 号: 2020312309000285

委 托 人	R. STAHL HMI Systems GmbH
地 址	Adolf-Grimme-Allee 8, 50829 Köln, Germany
生 产 者	R. STAHL HMI Systems GmbH
地 址	Adolf-Grimme-Allee 8, 50829 Köln, Germany
生 产 企 业	R. STAHL HMI Systems GmbH
生 产 地 址	Adolf-Grimme-Allee 8, 50829 Köln, Germany
产 品 名 称	防爆人机界面 (操作屏)
型 号 规 格	ET-**6-A-*-*
防 爆 标 志	见附页
依 据 标 准	GB/T 3836.1-2021, GB/T 3836.2-2021, GB/T 3836.3-2021, GB/T 3836.4-2021, GB/T 3836.9-2021, GB/T 3836.31-2021

认 证 模 式 型式试验+初始工厂检查+获证后监督

上述产品符合 CNCA-C23-01: 2019《强制性产品认证实施规则 防爆电气》
和 CNEX-C2301-2019《强制性产品认证实施细则 防爆电气》的要求。

产品相关信息见附页 (共 7 页)。

首次发证日期: 2020 年 09 月 02 日

颁发日期: 2023 年 04 月 28 日

有效期至: 2025 年 09 月 01 日

证书有效期内本证书的有效性依据发证机构的定期监督获得保持。

主任:



南阳防爆电气研究所有限公司



网址: www.ccc-cnex.com
ccc.china-ex.com

地址: 中国河南省南阳市仲景北路20号
电话: 0377-63239734

邮政编码: 473008
邮箱: ccc@cn-ex.com

CN 0025790



中国国家强制性产品认证证书 (附页)

编 号: 2020312309000285

第 1 页 共 7 页

产品相关信息:

1、本证书覆盖产品如下:

- ET-**6-A*-***

型号含义见下表:

ET	-	*	*	6	-	A	-	*	-	***
1		2	3	4		5		6		7
1	适用于 1 区或 21 区									
2	型号代码:		3=EAGLE(STAHL 操作系统)							
			4=开放式人机界面(Windows, Linux 操作系统)							
			5=远程人机界面(Windows 远程操作系统)							
3	尺寸代码:		0=10" VGA 显示							
			1=10" SVGA 显示							
			3=15"显示							
			5=19"显示							
4	系统代码 6									
5	版本 3									
6	FX=光纤局域网									
	TX=铜缆局域网									
7	*HDn*=配备硬盘驱动器 (内存大小 n)									
	SR=防眩光显示屏									
	附加信息 (与防爆无关)									

颁发日期: 2023 年 04 月 28 日

主任:



南阳防爆电气研究所有限公司



网址: www.ccc-cnex.com
ccc.china-ex.com

地址: 中国河南省南阳市仲景北路20号
电话: 0377-63239734

邮政编码: 473008
邮箱: ccc@cn-ex.com



中国国家强制性产品认证证书 (附页)

编 号: 2020312309000285

第 2 页 共 7 页

技术参数:

使用环境温度: 前部: $-30^{\circ}\text{C} \leq T_a \leq +55^{\circ}\text{C}$
后部: $-20^{\circ}\text{C} \leq T_a \leq +55^{\circ}\text{C}$

防护等级 IP66

电气参数:

1) 外部非本安电路

输入电压 (X1) :
额定电压 24V DC(+20%/-15%)
最高电压 U_m 30V AC
额定电流 1.5A

RS-422/-232 COM1(X2)端口:
额定电压 RS232 $\pm 12\text{V DC}$
RS422 5V DC
最高电压 U_m 253V AC

音频输出 (X3) :
额定电压 5V DC
最高电压 U_m 253V AC

USB-1 (X5) :
额定电压 5V DC
最高电压 U_m 253V AC

USB-3 (X7) :
额定电压 5V DC
最高电压 U_m 253V AC

LAN (X11) :
额定电压 5V DC

颁发日期: 2023 年 04 月 28 日

主任:



南阳防爆电气研究所有限公司



网址: www.ccc-cnex.com
ccc.china-ex.com

地址: 中国河南省南阳市仲景北路20号
电话: 0377-63239734

邮政编码: 473008
邮箱: ccc@cn-ex.com



中国国家强制性产品认证证书 (附页)

编 号: 2020312309000285

第 3 页 共 7 页

最高电压 U_m 30V AC
 RS-422/-232 COM2-3(X22)端口:
 额定电压 RS232 $\pm 12V$ DC
 RS422 5V DC
 最高电压 U_m 253V AC

2) 外部本安电路

允许叠加的 L 和 C 值组合, 结果请参见下表。

可以使用彼此正上方/正下方的 C_o 和 L_o 配对。

如果安装在 21 区中, 则 IIB 组的 L 和 C 最大值适用于本安电路。

(1) USB-0(X4)、USB-2(X6)

$U_o = 5.9$ V
 $I_o = 2.69$ A
 $P_o = 6.02$ W
 USB-0 (USB-2) 的所有连接都短路到 GND 时的总电流。
 当 USB-0 (USB-2) 的所有连接都短路到 GND 时可用的电源功率。

适用于 1 区 IIC 组的最大值

$L_i = 0$ mH	$L_o = 0.01$	0.005	0.002	0.001	mH
$C_i = 0$ μ F	$C_o = 5.1$	11	28	40	μ F

适用于 1 区 IIB 组的最大值

$L_i = 0$ mH	$L_o = 0.05$	0.02	0.01	0.005	mH
$C_i = 0$ μ F	$C_o = 14$	40	79	200	μ F

(2) ET-Reader-2-RSi1 and RSi2(X8)

Reader-2-RSi1 模块电源 (内部 UB_RDR 输出), 端子 X8.0 (桥接到 X8.2)

$U_o = 10.4$ V $I_o = 220$ mA $P_o = 2.29$ W

颁发日期: 2023 年 04 月 28 日

主任:



南阳防爆电气研究所有限公司



网址: www.ccc-cnex.com
ccc.china-ex.com

地址: 中国河南省南阳市仲景北路20号
电话: 0377-63239734

邮政编码: 473008
邮箱: ccc@cn-ex.com



中国国家强制性产品认证证书 (附页)

编 号: 2020312309000285

第 4 页 共 7 页

适用于 1 区 IIC 组的最大值

Li = 0 mH Lo = 0.01 mH
Ci = 1.72 μ F Co = 0.8 μ F

备注: 无与 X8.2 连接的 IIB 值参数, 允许使用 IIC 参数值

Reader-2-RSi1 模块电源输入, 端子 X8.2 (桥接到 X8.0)

Ui = 12.4 V li = 220 mA Pi = 2.29 W
Li = 0 mH Ci = 25 nF

Reader-2-RSi1 提供电源给读取设备, 端子 X8.3-4

Uo = 5.36 V lo = 220 mA Po = 1.18 W

适用于 1 区 IIC 组的最大值

Li = 0 mH Lo = 0.002 0.001 mH
Ci = 5.3 μ F Co = 40.7 59.7 μ F

适用于 1 区 IIB 组的最大值

Li = 0 mH Lo = 0.02 0.01 mH
Ci = 5.3 μ F Co = 70.7 124.7 μ F

Reader-2-Rsi1 和-Rsi2 信号输入/输出, 端子 X8.5-8

Ui = 15 V li = 500 mA Pi = 2.5 W
Uo = 5.36 V lo = 46 mA Po = 62 mW

适用于 1 区 IIC 组的最大值

Li = 0 mH Lo = 0.002 mH
Ci = 0 μ F Co = 46 μ F

适用于 1 区 IIB 组的最大值

Li = 0 mH Lo = 0.02 mH
Ci = 0 μ F Co = 79 μ F

颁发日期: 2023 年 04 月 28 日

主任:



南阳防爆电气研究所有限公司



网址: www.ccc-cnex.com
ccc.china-ex.com

地址: 中国河南省南阳市仲景北路20号
电话: 0377-63239734

邮政编码: 473008
邮箱: ccc@cn-ex.com



中国国家强制性产品认证证书 (附页)

编 号: 2020312309000285

第 5 页 共 7 页

(3) ET-Reader-2WCR1 and WCR2(X8)

Reader-2-WCR1, 模块电源 (来自外部本安电源) 端子 X8.1-2

$U_i = 11.4 \text{ V}$ $I_i = 200 \text{ mA}$ $P_i = 2.28 \text{ W}$
 $L_i = 0 \text{ mH}$ $C_i = 25 \text{ nF}$

Reader-2-WCR1 提供电源给读取设备, terminals X8.3-4

$U_o = 5.88 \text{ V}$ $I_o = 200 \text{ mA}$ $P_o = 1.18 \text{ W}$

适用于 1 区 IIC 组的最大值

$L_i = 0 \text{ mH}$ $L_o = 0.002 \text{ mH}$ 0.001 mH
 $C_i = 5.3 \text{ }\mu\text{F}$ $C_o = 27.7 \text{ }\mu\text{F}$ $37.7 \text{ }\mu\text{F}$

适用于 1 区 IIB 组的最大值

$L_i = 0 \text{ mH}$ $L_o = 0.02 \text{ mH}$ 0.01 mH
 $C_i = 5.3 \text{ }\mu\text{F}$ $C_o = 55.7 \text{ }\mu\text{F}$ $94.7 \text{ }\mu\text{F}$

Reader-2-WCR1 和-WCR2 信号输入/输出, 端子 X8.5-8

$U_i = 15 \text{ V}$ $I_i = 500 \text{ mA}$ $P_i = 2.5 \text{ W}$
 $U_o = 5.88 \text{ V}$ $I_o = 51 \text{ mA}$ $P_o = 75 \text{ mW}$

适用于 1 区 IIC 组的最大值

$L_i = 0 \text{ mH}$ $L_o = 0.002 \text{ mH}$
 $C_i = 0 \text{ }\mu\text{F}$ $C_o = 34 \text{ }\mu\text{F}$

适用于 1 区 IIB 组的最大值

$L_i = 0 \text{ mH}$ $L_o = 0.02 \text{ mH}$
 $C_i = 0 \text{ }\mu\text{F}$ $C_o = 63 \text{ }\mu\text{F}$

(4) 键盘和点触设备的保护等级 " ib" (X9)

$U_o = 5.88 \text{ V}$ $I_o = 200 \text{ mA}$ $P_o = 1.18 \text{ W}$

颁发日期: 2023 年 04 月 28 日

主任:

穆大玉



南阳防爆电气研究所有限公司



网址: www.ccc-cnex.com
ccc.china-ex.com

地址: 中国河南省南阳市仲景北路20号
 电话: 0377-63239734

邮政编码: 473008
 邮箱: ccc@cn-ex.com



中国国家强制性产品认证证书 (附页)

编 号: 2020312309000285

第 6 页 共 7 页

适用于 1 区 IIC 组的最大值

Li = 0	mH	Lo = 2	1	μH
Ci = 17.6	μF	Co = 15.4	25.4	μF

适用于 1 区 IIB 组的最大值

Li = 0	mH	Lo = 100	50	20	10	μH
Ci = 17.6	μF	Co = 10.4	20.4	43.4	82.4	μF

(5) 键盘和点触设备的保护等级 " ia " (X9)

Uo = 5.88	V	Io = 4.36	A	Po = 1.18	W
-----------	---	-----------	---	-----------	---

适用于 1 区 IIC 组的最大值

Li = 0	mH	Lo = 2	1	μH
Ci = 17.6	μF	Co = 13.4	25.4	μF

适用于 1 区 IIB 组的最大值

Li = 0	mH	Lo = 20	10	5	1	μH
Ci = 17.6	μF	Co = 32.4	74.4	202.4	982	μF

3) 外部本安型光接口 X10

波长= 1350 nm

辐射功率≤35 mW

外壳防护等级: IP66

防爆标志:

ET-**6-A-TX-***:

Ex db eb ia ib mb [ia ib Gb] IIC T4 Gb, Ex ia tb [ia ib Db] IIIC T80°C Db

ET-**6-A-FX-***:

颁发日期: 2023 年 04 月 28 日

主任:

穆大玉



南阳防爆电气研究所有限公司



网址: www.ccc-cnex.com
ccc.china-ex.com

地址: 中国河南省南阳市仲景北路20号
电话: 0377-63239734

邮政编码: 473008
邮箱: ccc@cn-ex.com



中国国家强制性产品认证证书 (附页)

编 号: 2020312309000285

第 7 页 共 7 页

Ex db eb ia ib mb [ia ib op is Gb] IIC T4 Gb, Ex ia tb [ia ib op is Db] IIC T80°C Db

- 生产者应按照认证机构批准的技术文件组织生产。

2、安全使用条件:

- 人机操作界面设备前部安装的防眩光显示屏 (类型代码含 "SR") 以及其他型号的显示屏表面涂装了一层附加膜, 只能用湿布清洁。

- 本产品认证不包括对光辐射 "op is" 标准的评价和试验。

- 本产品安装使用时, 应配用已获得 CCC 认证且适合使用条件的电缆引入装置和/或堵头, 并正确安装。

- 其他见产品使用说明书。

3、证书关联报告:

- 产品型式试验报告: CQST2005C017, CQST2005C017/01

- 工厂检查报告: CN2023Q030119

4、证书变更信息:

- 2023 年 04 月 28 日第 1 次变更: 产品认证依据标准变更。

颁发日期: 2023 年 04 月 28 日

主任: 穆大玉



南阳防爆电气研究所有限公司



网址: www.ccc-cnex.com
ccc.china-ex.com

地址: 中国河南省南阳市仲景北路20号
电话: 0377-63239734

邮政编码: 473008
邮箱: ccc@cn-ex.com

22.3 RCM

Supplier's declaration of conformity



As required by the following Notices:

- > *Radiocommunications (Compliance Labelling - Devices) Notice 2014* made under section 182 of the *Radiocommunications Act 1992*;
- > *Radiocommunications Labelling (Electromagnetic Compatibility) Notice 2017* made under section 182 of the *Radiocommunications Act 1992*
- > *Radiocommunications (Compliance Labelling – Electromagnetic Radiation) Notice 2014* made under section 182 of the *Radiocommunications Act 1992* and
- > *Telecommunications (Labelling Notice for Customer Equipment and Customer Cabling) Instrument 2015* made under section 407 of the *Telecommunications Act 1997*.

Instructions for completion

- > **Do not return this form to the ACMA.** This completed form must be retained by the supplier as part of the documentation required for the compliance records and must be made available for inspection by the ACMA when requested.

Supplier's details (manufacturer, importer or authorised agent)

Company Name (OR INDIVIDUAL)

R. STAHL Australia Pty Ltd
TRADING AS R. STAHL HMI Systems GmbH

ACN/ARBN

ABN 81 150955838

OR

New Zealand IRDN

--

Street Address (AUSTRALIAN or NEW ZEALAND)

848 Old Princes Highway
Sutherland, NSW
POSTCODE 2232
Phone: +61 2 4254 4777

Product details and date of manufacture

Product description – brand name, type, current model, lot, batch or serial number (if available), software/firmware version (if applicable)

<p>Operating and Monitoring Devices</p> <p>EXICOM ET-306-A-***; ET-406-A-***; ET-506-A-***; ET-316-A-***; ET-416-A-***; ET-516-A-***; ET-336-A-***; ET-436-A-***; ET-536-A-***; ET-356-A-***; ET-456-A-***; ET-556-A-***; * = Fx or Tx, ** = HDn and/or SR and/or additional information</p>
<p>Operating and Monitoring Devices</p> <p>EXICOM MT-306-A-***; MT-406-A-***; MT-506-A-***; MT-316-A-***; MT-416-A-***; MT-516-A-***; MT-336-A-***; MT-436-A-***; MT-536-A-***; MT-356-A-***; MT-456-A-***; MT-556-A-***; * = Fx or Tx, ** = HDn and/or SR and/or additional information</p>
<p>Keyboard</p> <p>KBD(i)-PS2-***; *** = In the complete type denomination, the asterisks are replaced by letters or numbers to identify different variations.</p>
<p>Keyboard with Joystick / Trackball</p> <p>KBD(i)-TB-PS2-***; KBD(i)-JS-PS2-***; **=any character without relevance for explosion protection</p>

Keyboard with Joystick
KBDI-JS2-PS2-xx; xx = The asterisks are replaced by letters to mark different country-specific keyboard-designs.

Compliance – applicable standards and other supporting documents

Evidence of compliance with applicable standards may be demonstrated by test reports, endorsed/accredited test reports, certification/competent body statements.

Having had regard to these documents, I am satisfied the above mentioned product complies with the requirements of the relevant ACMA Standards made under the *Radiocommunications Act 1992* and the *Telecommunications Act 1997*.

List the details of the documents the above statement was made, including the standard title, number and, if applicable, number of the test report/endorsed test report or certification/competent body statement

EN 61000-6-4:2011-09; EN 61000-6-4:2007 + A1:2011; EN 55022:1994 + A1:1995 + A2:19997

Declaration

I hereby declare that:

1. I am authorised to make this declaration on behalf of the Company mentioned above,
2. the contents of this form are true and correct, and
3. the product mentioned above complies with the applicable above mentioned standards and all products supplied under this declaration will be identical to the product identified above.

Note: Under section 137.1 of the *Criminal Code Act 1995*, it is an offence to knowingly provide false or misleading information to a Commonwealth entity.
Penalty: 12 months imprisonment

 <small>SIGNATURE OF SUPPLIER OR AGENT</small> John Zagame <small>PRINT NAME</small>	Managing Director <small>POSITION IN ORGANISATION</small> 2018-10-15 <small>DATE</small>
--	---

The *Privacy Act 1988* (Cth) (the Privacy Act) imposes obligations on the ACMA in relation to the collection, security, quality, access, use and disclosure of personal information. These obligations are detailed in the Australian Privacy Principles.

The ACMA may only collect personal information if it is reasonably necessary for, or directly related to, one or more of the ACMA's functions or activities.

The purpose of collecting the personal information in this form is to ensure the supplier is identified in the 'Declaration of conformity'. If this Declaration of Conformity is not completed and the requested information is not provided, a compliance label cannot be applied.

Further information on the Privacy Act and the ACMA's Privacy Policy is available at www.acma.gov.au/privacypolicy. The Privacy Policy contains details about how you may access personal information about you that is held by the ACMA, and seek the correction of such information. It also explains how you may complain about a breach of the Privacy Act and how we will deal with such a complaint.

Should you have any questions in this regard, please contact the ACMA's privacy contact officer on telephone on 1800 226 667 or by email at privacy@acma.gov.au.

23 Release notes

This chapter lists the changes made in the most recent versions of these Operating Instructions.

Version 03.00.40

- Removal of previous release notes
- Removal of HW Rev. ET-3x6-A-xx-BS devices at cover
- Removal of FSB notice
- Removal of EAC certification
- Removal of EAC Ex classification
- Removal of EAC declaration of conformity
- Correction r-stahl link
- Addition of table "Overview Hardware Revision" with "SERIES 300 with quad core processor"
- Addition of "Technical data" with "Hardware revision 03.00.x8 for ET-3x6-A-*"
- Changing arrangement in table "Ex classification"
- Addition of "Location classes" at "Technical data"
- Correction of information for "Cable glands" in "Technical data"
- Addition of notice for "Positive pressure operation" in "Technical data"
- Addition of type code for ET-3x6-A-* (Operator Interfaces) with BT quad core
- Addition of notice for FO interfaces at "Technical data"
- Addition of notice for FO interfaces at "Connections"
- Renew of CCC certification
- Addition of CCC Ex classification
- Exchange of CCC declaration of conformity
- Removal of CNEx certification, expired
- Addition of "TC" field function in certificates
- Addition of section "Installation Instructions Requirements China"
- Formal changes

Version 03.00.41

- Update BIS certification
- Update INMETRO certification
- Renaming CEC into CE-Code
- Correction of CE / ATEX listing in section "Certificates"
- Renew of Ex marking INMETRO
- Formal changes

R. STAHL HMI Systems GmbH
Adolf-Grimme-Allee 8
D 50829 Köln

T:	(Sales Support)	+49 221 768 06 - 1200
	(Technical Support)	+49 221 768 06 - 5000
F:		+49 221 768 06 - 4200
E:	(Sales Support)	sales.dehm@r-stahl.com
	(Technical Support)	support.dehm@r-stahl.com

r-stahl.com



THE STRONGEST LINK.