



Operating Instructions



Device platform MANTA

ET-xx7

SERIES 400 Panel PC
SERIES 500 Thin Clients
SERIES 600 KVM Systems



THE STRONGEST LINK.

Doc. No.: 6000076

HW-Rev. ET-6x7:	01.03.07
HW-Rev. ET-4x7*-BT:	01.03.07
HW-Rev. ET-5x7*-BT:	01.03.07
HW-Rev. ET-4x7*-P2:	01.03.07
HW-Rev. ET-5x7*-P2:	01.03.07
HW-Rev. ET-4x7*-PB:	01.03.08
HW-Rev. ET-5x7*-PB:	01.03.08

Operating Instructions version:	01.03.28
Issue date:	10.10.2024

Order number:	296926
---------------	--------

Disclaimer

Publisher and copyright holder:

R. STAHL HMI Systems GmbH
Adolf-Grimme-Allee 8
D 50829 Köln

Telephone:	(Sales Support)	+49 221 768 06	- 1200
	(Technical Support)		- 5000
Fax:			- 4200
E-mail:	(Sales Support)	sales.dehm@r-stahl.com	
	(Technical Support)	support.dehm@r-stahl.com	

- All rights reserved.
- This document may not be reproduced in whole or in part except with the written consent of the publisher.
- Subject to alterations.

Any warranty claims are limited to the right to demand amendments. Liability for any damage that might result from the contents of these instructions or all other documentation is limited to clear cases of premeditation.

We reserve the right to change our products and their specifications at any time, provided it is in the interest of technical progress. The information in the current manual (online or on CD / DVD / USB stick) or in the operating instructions included in the delivery applies.

Trademarks

The terms and names used in this document are registered trademarks and / or products of the companies in question.

Copyright © 2024 by R. STAHL HMI Systems GmbH. Subject to alterations

Specific markings

The markings in these operating instructions refer to specific features that must be noted.

In detail, these are:

 DANGER	This sign alerts users to hazards that will result in death or serious injury if ignored !
---	--

 WARNING	This sign alerts users to hazards that may result in death or serious injury if ignored !
--	---

 CAUTION	This sign alerts users to hazards that may damage machinery or equipment or result in injury if ignored !
--	---

 ATTENTION	Information highlighted by this symbol indicates measures for the prevention of damage to machinery or equipment !
--	--

 NOTICE	Information highlighted by this symbol (with and without lettering) indicates important information of which particular note should be taken !
---	--

 DOCUMENTATION	Information highlighted by this symbol (with and without lettering) refers to a different chapter or section in this manual or other documentation or a web-page !
--	--

Warnings

	Caution ! In ambient temperatures exceeding +45 °C the surface of the devices may heat up. Caution when touching !
---	--

	Caution ! The laser diodes installed in our operator devices, media converters and switches emit invisible laser radiation: 100Base-FX - 1300 nm FO-MM / 1000Base-SX - 770 ... 860 nm FO-SM / 1000Base-LX - 1270 ... 1355 nm Acc. to EN 60825-1 the laser diode is classified as a class 1M laser / Do not view directly with optical instruments. The viewing of the laser beam through certain optical instruments (e.g. magnifying glasses, telescopes and microscopes) from a distance of less than 100 mm may damage eyesight. (beam output at the emitting diode (TD-A, TD-B) or the fiber optic end).
---	--

Table of contents

	Description	Page
	Disclaimer	2
	Specific markings	3
	Warnings	3
	Table of contents	4
1	Preface	7
2	Device function	7
2.1	Image sticking	7
2.2	Processor types	7
2.3	Activation pressure touchscreen	7
2.4	ET-4x7 (SERIES 400 Panel PC)	8
2.5	ET-5x7 (SERIES 500 Thin Clients)	8
2.6	ET-6x7 (SERIES 600 KVM Systems)	8
2.7	Overview hardware revision	8
3	Type allocation	9
3.1	Type marking	9
4	Technical data	10
4.1	Additionally for ET-4x7 (Panel PC)	13
4.1.1	All devices up to hardware revision 01.03.00	13
4.1.2	All devices starting from hardware revision 01.03.01	13
4.1.3	All devices starting from hardware revision 01.03.03	13
4.1.4	ET-477 devices starting from hardware revision 01.03.04	13
4.1.5	ET-477 devices starting from hardware revision 01.03.08	14
4.2	Additionally for ET-5x7 (Thin Clients)	14
4.2.1	All devices up to hardware revision 01.03.00	14
4.2.2	All devices starting from hardware revision 01.03.01	14
4.2.3	All devices starting from hardware revision 01.03.03	14
4.2.4	ET-577 devices starting from hardware revision 01.03.04	15
4.2.5	ET-577 devices starting from hardware revision 01.03.08	15
4.3	Resolution at ET-6x7 (KVM Systems) with DVI3	15
5	Conformity to standards	16
5.1	CE-Code / NEC / CSA	17
5.2	Mounting inside enclosure	17
6	Certificates	18
	Europe (CE / ATEX)	18
	Global (IECEX)	18
	USA (NEC)	18
	Canada (CE-Code)	18
	India (BIS / PESO / CCE)	18
	China (CCC / CNEx)	18
	Korea (KCC / KCS)	18
	Australia (RCM)	18
	Marine / ship certification (DNV)	18
7	Marking	19
8	Power supply	20

8.1	HMI devices	20
9	Permitted maximum values	20
9.1	External, non-intrinsically safe circuits	20
9.2	External inherently safe optical interface	21
9.3	External intrinsically safe circuits	21
10	Type code	22
10.1	Standard	22
10.1.1	ET-4x7 (Panel PC)	22
10.1.2	ET-4x7-*-BT (Panel PC)	23
10.1.3	ET-477-*-P2 (Panel PC)	24
10.1.4	ET-477-*-PB (Panel PC)	25
10.1.5	ET-5x7 (Thin Client)	26
10.1.6	ET-5x7-*-BT (Thin Client)	27
10.1.7	ET-577-*-P2 (Thin Client)	28
10.1.8	ET-577-*-PB (Thin Client)	29
10.1.9	ET-6x7 KVM System	30
10.2	Type code representation for China	31
10.2.1	ET-xx7 (Panel PC / Thin Client)	31
10.2.2	ET-6x7 (KVM Systems)	32
11	Safety information	34
11.1	General Safety Information	34
11.2	Cautionary note	34
11.3	Installation safety information	34
11.3.1	Only for HMI devices with DVI3	36
11.3.2	HMI installation in enclosures with degree of protection "e" or "t"	36
11.3.3	Conditions of safe use according to CE-Code / NEC / CSA	37
11.3.4	Tightening torque	37
11.3.4.1	Terminals	37
11.3.4.2	Cable glands	37
11.4	Industrial Security	37
11.5	Safety information for operation	38
11.6	Special conditions	38
12	Assembly and disassembly	39
12.1	General information	39
12.2	Cut-out ET-xx7	39
12.3	Tightening torque	39
13	Operation	40
13.1	General information	40
13.2	Connections	40
14	General Information	43
14.1	Touch driver	43
14.2	ET-4x7 (Panel PC) and ET-5x7 (Thin Client)	43
14.2.1	Up to Windows 7 operating systems	43
14.2.1.1	Licensing issues	43
14.2.1.2	Note on Windows Embedded operating systems	43
14.2.2	Windows® 10 IoT Enterprise 2019 / 2021 LTSC operating system	43
14.2.2.1	Recovery	44

14.2.2.2	Company-specific Windows installations	44
14.2.3	Initial start-up ET-4x7 (Panel PC)	44
14.2.4	Recovery Stick	44
14.2.5	Back-up	44
14.2.6	Switching off / closing down	45
14.2.7	Data loss	45
14.3	Teaming function	45
15	Maintenance, overhaul	46
15.1	Damaged sealing	46
16	Troubleshooting	46
16.1	Repairs / hazardous substances	46
17	Disposal / Restricted substances	47
17.1	Declaration of substances and restricted substances	47
17.1.1	Declarable substance groups	47
17.1.2	RoHS directive 2011/65/EC	47
17.1.3	IMO Resolution MEPC.269(68)	47
18	Defective pixels	48
18.1	Terminology	48
18.2	Display specification ET-x77	49
19	Optical acceptance of surfaces	50
19.1	Optical acceptance glass	50
19.2	Optical acceptance printing	51
19.3	Optical acceptance, other surfaces	51
20	Control Drawing CE-Code / NEC / CSA	53
21	Mounting inside enclosure with ET-xx7 mounting-set	55
22	Installation Instructions Requirements China	57
23	Declarations of conformity	58
23.1	EC	58
23.2	CCC	59
23.2.1	English version	59
23.2.2	Chinese version	69
23.3	RCM	78
24	Release notes	80

1 Preface

These Operating Instructions contain all aspects relevant to explosion protection for the ET-xx7 devices - device platform MANTA - (SERIES 400 Open HMI - Panel PC's, SERIES 500 Thin Clients and SERIES 600 KVM Systems). They also contain information on the connection and installation (etc.) of these devices.

 NOTICE	All data relevant to explosion protection from the EC-type examination certificate were copied into these operating instructions.
	For the correct operation of all associated components please note, in addition to these operating instructions, all other operating instructions enclosed in this delivery as well as the operating instructions of the additional equipment to be connected !

 DOCUMENTATION	Please note that all certificates of the HMI devices can be found in a separate document (CE_ET-xx7).
	You can find this document in the internet at r-stahl.com or request it from R. STAHL HMI Systems GmbH.

2 Device function

The ET-xx7 units are explosion-protected equipment for installation in hazardous areas and can be operated in zones 1 and 21 with interfaces for zones 0/1/2 and 20/21/22.

The devices are connected to a communication system via the serial interfaces (RS-232, Ethernet) located in their connection box at the rear. The connection box also contains the USB interfaces for the connection of various peripheral devices. Furthermore, the interfaces for keyboard, mouse, video and audio signals are also located here.

2.1 Image sticking

Continuous displaying fixed pattern may include image sticking. It's recommended to use screen saver or moving content periodically if fixed pattern is displayed on the screen.

2.2 Processor types

All devices of 400 and 500 SERIES are fitted with modern, powerful processors. Depending on the type of application, different processor types are used for the HMI devices (see Technical Data).

Starting in 2016, a new Intel® ATOM™ processor type of the Bay Trail (BT) platform will gradually replace all previous processor types in the HMI devices, up from HW Revision 01.03.01. This new processor type processes data four times as fast as the previous processors.

In addition to the Bay Trail (BT) processor, the devices of 400 and 500 SERIES will be equipped with an AMD GX processor, up from HW Revision 01.03.04.

From HW-Rev. 01.03.08, the SERIES 400 and 500 devices will be equipped with an Intel® ATOM™ E3940 (PB) processor.

2.3 Activation pressure touchscreen

To prevent damage to the touchscreen, activation pressure on the screen with polyester foil must be very low (0.1 to max. 1 N) and on the screen with glass surface must be medium (1.8 to max. 2.5 N) !

2.4 ET-4x7 (SERIES 400 Panel PC)

The ET-4x7 HMI panel PCs are intelligent display and operating devices which can run any software and are thus easy to operate.

The devices are fitted with powerful processors and are thus able to process even large applications on-site. The devices have a back-up and recovery system which can be used to save complete images and load them onto new Panel PCs without requiring specific IT skills. The X13 interface is provided for this purpose.

2.5 ET-5x7 (SERIES 500 Thin Clients)

The ET-5x7 devices of the 500 SERIES can be integrated into modern networks as Thin Clients or with a KVM box via KVM-over-IP. Digital Ethernet technology is used for the data transfer between KVM box and Remote System.

Up to four ET-5x7 devices can access one KVM box with one software license, thus cost-effectively communicating with several PCs - for example, when monitoring the production process and simultaneously applying Condition Monitoring.

Multi-monitoring with several on-site terminals can as easily be implemented as the application as Thin Client in a server environment with virtual work stations.

2.6 ET-6x7 (SERIES 600 KVM Systems)

The KVM Classic transfer technology is used for the point-to-point connection between a PC and an ET-6x7 KVM device.

There are three versions (DVI1, DVI2 and DVI3) of this transfer technology that have slightly different functionality.

2.7 Overview hardware revision

HW-Rev.	Device type	Technical changing	Changing date hardware	OI version	OI date
01.02.00	ET-xx7-*	Changing from T-Ex to ET-xx7	01.01.2013	01.02.00	17.04.2013
01.03.00	ET-xx7-*	NEC / CEC approval	12.12.2014	01.03.00	08.01.2015
01.03.01	ET-4x7-*-BT-*	Bay Trail processor, quad core	01.07.2016	01.03.02	04.01.2016
01.03.02	ET-4x7-*-BT-*	SX with TX	15.01.2018	01.03.09	21.12.2017
01.03.03	ET-4x7-*-BT-*	M.2 memory	14.06.2018	01.03.11	29.08.2018
01.03.04	ET-4x7-*-P2-*	AMD processor GX-222GC	31.03.2019		
01.03.05	ET-4x7-*-BT-*	BIOS update BIOS-V1.63r4 no C6	29.06.2021	01.03.21	27.09.2021
	ET-4x7-*-BT-*	Changing cable glands			
01.03.06	ET-xx7-*	New front panel seal	18.11.2022	01.03.25	25.11.2022
01.03.07	ET-xx7-*	Changing front panel seal	01.07.2023	01.03.26	08.09.2023
01.03.08	ET-xx7-*-PB-*	Integration mITX board with ATOM E3940 processor	01.01.2024	01.03.27	23.01.2024

3 Type allocation

Since the beginning of 2013, the T-series devices have been allocated new type names according to the following pattern:

To avoid having to re-write certifications, the names in the certificates remain the same, but the devices receive new names.

In the interest of a clear link between device type and certificate, both device names are listed on the type plate from 01.04.2013 onwards.

3.1 Type marking

Old (certificate)	New
T-Ex-##*-CAT7*-R2	ET-##7*-TX* / ET-##7-2TX*
T-Ex-##*-CAT7*-R2	ET-##7*-CAT*
T-Ex-##*-MM*-R2	ET-##7*-MM* / ET-##7-SX*
T-Ex-##*-SM*-R2	ET-##7*-SM* / ET-##7-LX*

* = alphanumeric or symbolic characters without relevance to explosion protection.

= numeric character without relevance to explosion protection.



NOTICE

For the exact new device name and model please refer to the type code.

4 Technical data

Function / Equipment	ET-467 ET-567 ET-667	ET-477 ET-577 ET-677	ET-487 ET-587 ET-687
Display type	TFT Color display 16.7 million colours		
Display size	56 cm (22")	61 cm (24")	61 cm (24"WU)
Resolution in pixels	WSXGA+ 1680 x 1050	Full HD 1920 x 1080	WUXGA 1920 x 1200
Format	16:10	16:9	16:10
Viewing angle	at CR ≥ 5		
Horizontal	178°	178°	178°
Vertical	170°	170°	178°
Display	Glass		
Touchscreen (optional)	Polyester foil or glass surface 5-wire analogue resistive		
Backlight	LED background lighting		
Service life (MTBF) of backlight at 20 °C / 68 °F	Typically 50,000 h		
Brightness	250 cd/m ²	300 cd/m ²	
Contrast	1000 : 1		
Anti-reflective display	Devices without touchscreen: chemically coated Devices with foil touchscreen: lightly anti-reflective (foil is abraded for slight milky effect) Device with glass touchscreen: not anti-reflective, glass is too thin for chemical or mechanical treatment		
Touchscreen activation	Foil touch: low activation pressure (0.1 up to max. 1 N) Glass touch: medium activation pressure (1.8 up to max. 2.5 N)		
Touchscreen input method	Finger, gloved finger or stylus		
Touchscreen durability	Foil touch: Polyester foil is easily scratched, with high pressure force the spacer dots could be damaged. Glass touch: Quite good, but with high pressure force the spacer dots could be damaged.		
Touchscreen scratch hardness MoHS	Foil touch: - Glass touch: >5		
Touchscreen scratch hardness pencil hardness test ISO 15184	Foil touch: 3H Glass touch: 9H		
Touchscreen transmissivity / optics	Foil touch: small milky effect due to the foil Glass touch: very good		
Touchscreen surface contaminants	Unaffected		
Touchscreen abrasive resistance	36 million times with a silicone rubber of R8 finger, hitting rate 250 g at 2 times per second		
Additional keyboard (optional)	107 keys with integrated trackball / joystick / mouse pad or touch pad		
Power supply	Directly in the integrated Ex e connection box		
Rated operational voltage AC	230 V		
Voltage range AC	100 - 240 V		
Frequency range	50 - 60 Hz		
Rated operational voltage DC	24 V		
Voltage range DC	20 - 30 V		
Power	Typically 50 W / 100 W at O30 / max. 150 W (typically 170 BTU / 341 BTU at O30 / max. 510 BTU)		
Current consumption AC	1 A		
Current consumption DC	3 A		
Connections	via screw terminals, green Flexible cable up to 2.5 mm ² (AWG14) Fixed cable up to 4 mm ² (AWG12)		
Recommended fuses	4 AT		
Max. operating voltage Um	250 VAC		

Interfaces	
Ethernet	Either copper or optical fiber *
at ET-4x7 and ET-5x7	for information on copper, see sections 4.1 and 4.2
Optical fiber (SX)	1000Base-SX, 1000 Mbit, multi-mode, intrinsically safe (Ex op is)
Optical fiber (LX)	1000Base-LX, 1000 Mbit, single mode, intrinsically safe (Ex op is)
* Note optical fiber (SX and LX)	Up from HW-Rev. 01.03.02, all ET-4x7 and ET-5x7 devices with SX or LX Ethernet interface are fitted additional with an Ethernet 10/100/1000Base-TX interface !
at ET-6x7	
Copper (CAT)	Direct connection, Gigabit
Optical fiber (FO) (MM / SM)	Direct connection
USB	2x Ex ia; 1x Ex e / USB 2.0, 480 Mbit/s
USB	for keyboard and mouse (Ex ia) / USB 2.0, 480 Mbit/s
Note on USB interfaces	The USB interfaces are based on USB 2.0. Due to explosion protection rules, the USB interface properties (such as speed or power supply) may be restricted.
Serial	RS-232, (Ex e)
Video in (optional)	FBAS (Ex e) (not AMD and E3940 version)
Audio	Line out interface (Ex e) (Line in only at ET-6x7) (not E3940 version)
Audio sound (optional)	Audio amplifier (mono amplifier) 3.5 W, for 2x loudspeaker connection (Ex e) (not AMD and E3940 version)
Voltage output	12 VDC, max. 500 mA **
** Note	The voltage output has an internal fuse that cannot be replaced !
Only for ET-4x7 and ET-5x7	
Real-time clock	yes
Data buffer	Lithium battery and capacitor buffered, maintenance-free
Battery	> 5 years
Capacitor	at least 4 days
Cable type optical fiber	
SX or MM	Multi-mode optical fiber cable (50 µm core cross section and 125 µm external cross section)
LX or SM	Multi-mode optical fiber cable (62.5 µm core cross section and 125 µm external cross section) Single mode optical fiber cable (9 µm core cross section and 125 µm external cross section)
Data cable lengths	
Optical fiber	
SX or MM	up to 550 m (1,804 ft) via 50/125 µm optical fiber cable up to 275 m (902 ft) via 62.5/125 µm optical fiber cable
LX or SM	up to 10,000 m (33,000 ft) via 9/125 µm optical fiber cable
Copper (TX)	up to 100 m (330 ft) via CAT7 installation cable AWG23 at 1x TX 2x up to 100 m (330 ft) via CAT7 installation cable AWG23 at 2TX
Copper (CAT)	
for DVI1	up to 140 m (460 ft) via CAT7 installation cable AWG23
for DVI2	up to 500 m (1,640 ft) via CAT7 installation cable AWG23
for DVI3	up to 150 m (492 ft) via CAT7 installation cable AWG23
Note CAT cable	Minimum requirement is CAT5e, CAT7 recommended



When using the fibre optic interfaces of MANTA devices, they must be connected and safely operated with other devices that comply with the limit values of Class 1 according to IEC 60825-1 or are classified as inherently safe optical radiation "op is" according to IEC 60079-28.

Enclosure	Steel
Enclosure protection type	Front IP66 / back IP65
HMI Types	PM = PanelMount = panel mount device OS = Operator Station
HMI Types comment	Panel mount device (PM): devices without additional enclosure (HSG) and without additional accessories Operator Station (OS): devices mounted inside additional enclosure (HSG)
Cable glands	
Type *	HSK-M-Ex (Ex e)
Number	2 x M16 / 1 x M20 / 3 x M25
Thread size	M16 x 1.5 / M20 x 1.5 / M25 x 1.5
Cable diameter range	1x M16 = 4 ... 8 mm / 1x M16 = 5 ... 10 mm / M20 = 7 ... 13 mm / M25 = 14 ... 18 mm
Width across flats	M16 = SW20 / M20 = SW24 / M25 = SW30
Mounting version keyboards	when wiring KBDi-USB, use the cable glands 2x M16 4... 8 mm (1x enclosed loose, exchange it for 1x M16 5... 10 mm) when wiring KB2, use the cable gland 1x M16 5... 10 mm (is pre-assembled)
* Comment	Similar certified cable glands may be used.
* Comment a	Not used cable glands must be closed by certified screw plugs or stopping plugs !

Permitted ambient temperature range	-30 °C ... +60 °C / [-22 °F ... +140 °F]		
Operating temperature range			
Cold start temperature *	-10 °C / [+14 °F]		
Operation **	-20 °C ... +60 °C / [-4 °F ... +140 °F]		
Operation with heater version O30 ***	-30 °C ... +60 °C / [-22 °F ... +140 °F]		
Storage temperature range	-30 °C ... +70 °C / [-22 °F ... +158 °F]		
* Note on cold start temperature	If the device is switched on in an ambient temperature of below -10 °C / [+14 °F], the display will require some time warming up before everything is clearly visible. Depending on how low the actual temperature is, this process may take up to 3 hours.		
** Note on operation	Operation at +60 °C / [+140 °F] for a maximum of 5 hours, at +50 °C / [+122 °F] for continuous operation (24/7)		
*** Note on the O30 version	The O30 version is only available for the AC version devices ! (not AMD and E3940 version)		
HMI Types comment OS	If the HMI device is installed in an additional enclosure (HSG), the upper temperature limit is reduced by 5 °C / [41 °F], due to the device's own heating and lower temperature dissipation in the additional enclosure ! Thus, the operator stations offers "only" an operation temperature range of -20 °C ... +55 °C / [-4 °F ... +131 °F] !		
Operating temperature range for DV11			
Cold start temperature	+5 °C [+41 °F]		
Operation	+5 °C ... +40 °C / [+41 °F ... +104 °F]		
Storage temperature range	-20 °C ... +70 °C / [-4 °F ... +158 °F]		
Heat dissipation	About 40 % via the front plate and 60 % via the enclosure		
Relative humidity	10 to 90 % at +40 °C / [+104 °F], non-condensing		
for DV11	20 to 80 % at +40 °C / [+104 °F], non-condensing		
Environmental conditions	Valid for all devices		
	Level	Test specification	
Damp heat (cyclic) (only device with glass touch (TG))	+55 °C (±2 °C) ≥95 %	IEC 60068-2-30 : 2005	
Dry heat	+65 °C	IEC 60068-2-2 : 2007 IEC 60068-2-78 : 2012	
Vibration (sinus)	5 up to 13.2 Hz: ±1 mm 13.2 up to 100 Hz: ±0.7 g Sweep cycle 1 oct/min Axis X, Y, Z	IEC 60068-2-6 : 2008	
	71.7 up to 79.2 Hz: ±0.7 g 120 min. Sweep cycle 1 oct/min Axis X	IEC 60068-2-6 : 2008 Dwell test	
	30 Hz: ±0.7 g 90 min. Sweep cycle 1 oct/min Axis Y, Z		
Environmental conditions	valid for DNV approved devices, see "Device restriction - notice DNV" in certificates		
Location classes	according to DNV guideline CG-0339		
	Temperature	D	
	Humidity	B	
	Vibration	A	
	EMC	A	
	Enclosure	The required protection must be provided in accordance with DNV regulations during installation on board.	
Dimensions			
Front (w x h)	660 mm x 475 mm (25.98" x 18.70")		
Cut-out (w x h) (+/-0.5 mm) (0.002")	615 mm x 435 mm (24.21" x 17.13")		
Depth of cut-out	110 mm (4.33")		
Wall thickness	≤5 mm (0.02")		
Cut-out dimension for rear mount module (w x h)	475.7 mm x 298.1 mm (18.73" x 11.74")	523 mm x 295 mm (20.59" x 11.61")	520.4 mm x 326 mm (20.49" x 12.83")
Mounting position	Vertical or horizontal		
Weight	32.00 kg (70.55 lbs)		

4.1 Additionally for ET-4x7 (Panel PC)

4.1.1 All devices up to hardware revision 01.03.00

Processor	Intel® ATOM™ N270; 1.6 GHz
RAM	1 or 2 GB
Data memory	4 or 16 GB
	128 GB MLC
	128 GB SLC
Type of data memory	Flash memory (SATA)
Operating system	Windows XP Embedded / Windows XP Professional / Windows 7 Ultimate (32 bit)
Global language support	Via Multi-Language interface of Windows XP Embedded (25 languages)
Interface copper (TX)	1x 10/100Base-TX, 10/100 Mbit (Ex e)

4.1.2 All devices starting from hardware revision 01.03.01

Processor	Intel® Bay Trail (BT) ATOM™ E3845 Quad Core; 1.91 GHz		
RAM	4 GB		
Data memory	Size	TBW	Test profile
	64 GB MLC	18.75	JESD218 Client profile
	128 GB MLC	37.5	
Type of data memory	Flash memory (Solid state drive - SSD) (internal via CF-Slot)		
Graphics controller	Integrated Intel Gen. 7 HD Graphics		
Operating system	Windows Embedded Standard 7 (64 bit) / Windows 7 Ultimate (64 bit)		
Global language support	Via Windows operating system		
Interface copper (TX)	1x 10/100Base-TX, 10/100 Mbit (Ex e)		
	or		
	2x 10/100Base-TX, 10/100 Mbit (Ex e)		
Note copper	If the customer installs an operation system, the driver for the "USB-SK-LAN-Adapter" must be installed. For this, please contact support.dehm@r-stahl.com . (Driver is part of STAHL images)		

4.1.3 All devices starting from hardware revision 01.03.03

Type of data memory	Flash memory M.2 (Solid State Drive - SSD) (internal via SATA)
Storage capacity of data memory	Note: The indication of the available data storage capacity may vary slightly, since the manufacturers reserve a certain area (spare bytes) to ensure long-term stability.
Operating system	Windows 10 IoT Enterprise 2019 LTSC (64 bit) (included in standard delivery) Windows 10 IoT Enterprise 2019 LTSC (32 bit) (optional on USB stick)

4.1.4 ET-477 devices starting from hardware revision 01.03.04

Processor type	AMD GX-222GC
Processor details	2.2 GHz; Dual Core, 10W TDP
Graphics controller	Integrated AMD Radeon R5E Graphics
Interface copper (TX)	1x 10/100Base-TX, 10/100 Mbit (Ex e)
	or
	2x 10/100Base-TX, 10/100 Mbit (Ex e)

4.1.5 ET-477 devices starting from hardware revision 01.03.08

Processorboard	miTX motherboard		
Processor type	Intel® ATOM™ E3940 (Apollo-Lake-I) quad core; 1.8 GHz		
Processor details	1.6 / 1.8 GHz; quad core, 6-12W TDP		
RAM	4 GB		
Data memory	Size	TBW	Test profile
	64 GB MLC	18.75	JESD218 Client profile
	128 GB MLC	37.5	
Type of data memory	Flash memory M.2 (Solid State Drive - SSD) (NVMe)		
Storage capacity of data memory	Note: The indication of the available data storage capacity may vary slightly, since the manufacturers reserve a certain area (spare bytes) to ensure long-term stability.		
Graphics controller	Integrated Intel® HD-Graphics 500		
Operating system	Windows 10 IoT Enterprise 2021 LTSC (64 bit) (included in standard delivery) Windows 10 IoT Enterprise 2021 LTSC (32 bit) (optional on USB stick)		
Interfaces Ethernet			
Copper (TX)	2x 10/100Base-TX, 10/100 Mbit (Ex e)		
Optical fiber (SX)	1000Base-SX, 1000 Mbit, multi-mode, intrinsically safe (Ex op is)		
Optical fiber (LX)	1000Base-LX, 1000 Mbit, single mode, intrinsically safe (Ex op is)		
Note optical fiber (SX and LX)	All ET-477 devices with SX or LX Ethernet interface are fitted additional with an Ethernet 10/100/1000Base-TX interface !		

4.2 Additionally for ET-5x7 (Thin Clients)

4.2.1 All devices up to hardware revision 01.03.00

Processor	AMD Geode LX 800; 266 MHz
RAM	512 MB 2 GB *
Data memory	1 GB 16 GB *
Operating system	Windows Embedded Standard 2009 and Remote Firmware Windows Embedded Standard 7, Remote Firmware and Delta V *
Interface copper (TX)	1x 10/100Base-TX, 10/100 Mbit (Ex e)

! NOTICE	* The combination of 2 GB RAM with 16 GB data memory is only available for the operating system with Delta V !
-----------------	--

4.2.2 All devices starting from hardware revision 01.03.01

Processor	Intel® Bay Trail (BT) ATOM™ E3845 Quad Core; 1,91 GHz		
RAM	4 GB		
Data memory	Size	TBW	Test profile
	64 GB MLC	18.75	JESD218 Client profile
	128 GB MLC	37.5	
Type of data memory	Flash memory (SATA)		
Graphics controller	Integrated Intel Gen. 7 HD Graphics		
Operating system	Windows 10 IoT Enterprise 2019 LTSC and Remote Firmware V6		
Interface copper (TX)	1x 10/100Base-TX, 10/100 Mbit (Ex e)		
	or		
	2x 10/100Base-TX, 10/100 Mbit (Ex e)		
Note copper	If the customer installs an operation system, the driver for the "USB-SK-LAN-Adapter" must be installed. For this, please contact support.dehm@r-stahl.com . (Driver is part of STAHL images)		

4.2.3 All devices starting from hardware revision 01.03.03

Type of data memory	Flash memory M.2 (Solid State Drive - SSD) (internal via SATA)
Storage capacity of data memory	Note: The indication of the available data storage capacity may vary slightly, since the manufacturers reserve a certain area (spare bytes) to ensure long-term stability.

4.2.4 ET-577 devices starting from hardware revision 01.03.04

Processor type	AMD GX-222GC
Processor details	2.2 GHz; Dual Core, 10W TDP
Graphics controller	integrated AMD Radeon R5E graphics
Interface copper (TX)	1x 10/100Base-TX, 10/100 Mbit (Ex e)
	or
	2x 10/100Base-TX, 10/100 Mbit (Ex e)

4.2.5 ET-577 devices starting from hardware revision 01.03.08

Processorboard	miTX motherboard		
Processor type	Intel® ATOM™ E3940 (Apollo-Lake-I) quad core; 1.8 GHz		
Processor details	1.6 / 1.8 GHz; quad core, 6-12W TDP		
RAM	4 GB		
Data memory	Size	TBW	Test profile
	64 GB MLC	18.75	JESD218 Client profile
	128 GB MLC	37.5	
Type of data memory	Flash memory M.2 (Solid State Drive - SSD) (NVMe)		
Storage capacity of data memory	Note: The indication of the available data storage capacity may vary slightly, since the manufacturers reserve a certain area (spare bytes) to ensure long-term stability.		
Graphics controller	Integrated Intel® HD-Graphics 500		
Operating system	Windows 10 IoT Enterprise 2021 LTSC and Remote Firmware V7		
Interfaces Ethernet			
Copper (TX)	2x 10/100Base-TX, 10/100 Mbit (Ex e)		
Optical fiber (SX)	1000Base-SX, 1000 Mbit, multi-mode, intrinsically safe (Ex op is)		
Optical fiber (LX)	1000Base-LX, 1000 Mbit, single mode, intrinsically safe (Ex op is)		
Note optical fiber (SX and LX)	All ET-477 devices with SX or LX Ethernet interface are fitted additional with an Ethernet 10/100/1000Base-TX interface !		

4.3 Resolution at ET-6x7 (KVM Systems) with DVI3

Function / Equipment	ET-667	ET-677	ET-687
Resolution in pixels	1680 x 1050	1920 x 1080	1920 x 1200
	1280 x 1024	1600 x 1000	1920 x 1080
	1280 x 960	1400 x 1050	1680 x 1050
	1152 x 864	1360 x 768	1600 x 1200
	1024 x 768	1280 x 1024	1280 x 1024
	800 x 600	1280 x 960	1280 x 960
		1280 x 800	1280 x 800
		1152 x 864	1152 x 864
		1024 x 768	1024 x 768
		800 x 600	800 x 600

5 Conformity to standards

The ET-xx7 devices comply with the following standards and directive:

Standard	Classification
2. Supplement	
ATEX directive 2014/34/EU	
EN 60079-0 : 2009	General requirements
EN 60079-5 : 2007	Powder filling "q"
EN 60079-7 : 2007	Increased safety "e"
EN 60079-11 : 2007	Intrinsic safety "i"
EN 60079-26 : 2007	Device protection (EPL) "Ga"
EN 60079-28 : 2004	Optical radiation
EN 60079-31 : 2009	Protected by enclosures "tD" (dust)
EN 61241-11 : 2006	Intrinsic safety "iD" (dust)
The product corresponds to requirements from:	
EN 60079-0 : 2012 + A11 : 2013	General requirements
EN IEC 60079-0 : 2018	
EN 60079-5 : 2015	Powder filling "q"
EN 60079-7 : 2015	Increased safety "e"
EN IEC 60079-7 : 2015 + A1 : 2018	
EN 60079-11 : 2012	Intrinsic safety "i"
EN 60079-26 : 2015	Device protection (EPL) "Ga"
EN 60079-28 : 2016	Optical radiation
EN 60079-31 : 2014	Protected by enclosures "tD" (dust)
Electromagnetic compatibility	
EMC directive	
2014/30/EU	Classification
EN 61000-6-2 : 2005	Interference resistance
EN 61000-6-4 : 2007 + A1 : 2011	Interference emission
Low voltage directive	
Directive 2014/35/EU	
EN 61010-1 : 2001+	General requirements
EN 62368-1 : 2016 IEC 62368-1 : 2014	Audio / video, information and communication technology equipment - Safety requirements
RoHS directive	
2011/65/EU	Classification
EN IEC 63000 : 2018	Technical documentation for the assessment of electrical and electronic products with respect to the restriction of hazardous substances

5.1 CE-Code / NEC / CSA

Standard	Classification
CAN/CSA-C22.2 No. 0-10 August 2011	General requirements Canadian Electrical Code, Part II
CAN/CSA-C22.2 No. 61010-1-12	Safety Requirements for Electrical Equipment for Measurement, Control, and Laboratory Use - Part 1: General Requirements (Third Edition)
CAN/CSA-C22.2 No. 60079-0 : 11 (December 2011)	Explosive atmospheres – Part 0: Equipment General requirements
CAN/CSA-C22.2 No. 60079-5 : 11 (December 2011)	Explosive atmospheres – Part 5: Equipment protection by powder filling “q”
CAN/CSA-C22.2 No. 60079-7 : 12 (February 2012)	Explosive atmospheres – Part 7: Equipment protection by increased safety “e”
CAN/CSA-C22.2 No. 60079-11 : 11 (December 2011)	Explosive atmospheres – Part 11: Equipment protection by intrinsic safety “i”
CAN/CSA-C22.2 No. 60529:05 (Reaffirmed 2010)	Degrees of protection provided by enclosures (IP Code)
ANSI/UL 61010-1 (2012)	Electrical Equipment for Measurement, Control, and Laboratory Use - Part 1: General Requirements (Third Edition)
ANSI/UL 60079-0 (sixth edition July 2013)	Explosive atmospheres – Part 0: Equipment – General requirements
ANSI/UL 60079-5 (third edition November 2013)	Explosive atmospheres – Part 5: Equipment protection by powder filling “q”
ANSI/UL 60079-7 (fourth edition May 2013)	Explosive atmospheres – Part 7: Equipment protection by increased safety “e”
ANSI/UL 60079-11 (sixth edition March 2014)	Explosive atmospheres – Part 11: Equipment protection by intrinsic safety “i”
ANSI/IEC 60529-2004	Degrees of protection provided by enclosures (IP code)

5.2 Mounting inside enclosure

The ET-xx7 devices can be mounted in an enclosure with suitable cut-out using an mounting kit. This mounting kit is approved for mounting in an Ex e, Ex p or Ex tb protected enclosure and consist of a sealing fixed at the HMI device and 24 nuts.

The assembly is shown in drawing “10410300 T-Ex - xx7 Mounting Assembly Overview”.

The sealing must be in correct position and must not be damaged.

The nuts must be mounted with a torque of 1.0 Nm ... 1.4 Nm.

 NOTICE	Mounting in an Ex e, Ex p or Ex tb enclosure for ET-xx7 devices with HW-Rev. 01.03.06 is not permitted !
---	--

6 Certificates

The ET-xx7 devices are certified for installation in the following areas:

Synonym	Scope	Certificate number	Valid until	Comment
CE	Europe		unlimited	According to directive 2014/30/EU 2014/34/EU 2014/35/EU 2011/65/EU
ATEX	Europe	BVS 11 ATEX E 102 X	unlimited	
IECEX	Global	IECEX BVS 11.0075X	unlimited	
NEC	USA	CSA 70011698	unlimited	
CE-Code	Canada			see notice CE-Code
BIS	India	R-41228087	26.06.2026	Device restriction see notice BIS
PESO		A/P/HQ/TN/104/6410 (P573384)	31.12.2027	
CCE		P573384/2		Identification number
CCC	China	2021312309000500	08.06.2026	
CNEEx		CNEEx21.1938X	16.06.2026	
KCC	Korea		unlimited	Device restriction see notice KCC
KCS		12-GA4BO-0617X	unlimited	
RCM	Australia		unlimited	According to declaration of conformity
DNV	Marine- / ship certification	TAA00000BK	01.12.2026	Device restriction see notice DNV

 DOCUMENTATION	You can access all IECEx certificates on the official website of the IEC under their certificate number. https://www.iecex-certs.com/#/home .
--	---

 NOTICE	For the device versions ET-477-*-PB and ET-577-*-PB with Intel® ATOM™ E3940 processor, up from hardware revision 01.03.08, only the approvals according to ATEX, IECEx and BIS / PESO / CCE apply in the following !
---	--

 NOTICE	Note CE-Code: The HMLs are certified according to Ex e q [ia] IIC T4 Gb. According to the CEC Part 1 each device with these protection types may be operated in Class I, Division 2 areas. For more details on this, please refer to the CEC.
---	---

 NOTICE	Note BIS: The following devices have the BIS certification: ET-477-TX-BT-*, ET-477-SX-BT-*, ET-477-SX-P2-*, ET-477-LX-BT-*, ET-477-LX-P2-*, ET-577-TX-BT-*, ET-577-SX-BT-*, ET-577-SX-P2-*, ET-577-LX-BT-*, ET-577-LX-P2-*, ET-577-2TX-BT-*, ET-577-2TX-P2-*, ET-477-*-PB, ET-577-*-PB
---	--

Note KCC:

	<p>In order to be able to operate these HMI devices in Korea, each device type additionally requires a KCC certificate. Actually the following devices has such a certificate: T-Ex-22 (ET-x67), T-Ex-22-DVI3 (ET-667-DVI3), T-Ex-24T (ET-x77 with touch screen (foil))</p> <p>The importer have to use exception documents which are applied in Korea rule for Korea. A corresponding example document, the so-called "Customer confirmation letter", is included in the CE_ET-xx7 certificate compilation of the devices.</p>
--	--

	<p>Note DNV: Only the HMI devices type: ET-667-DVI3-yM-FO-TFT-TG-AC-O30-AL ET-677-DVI3-yM-FO-TFT-TG-AC-O30-AL ET-687-DVI3-yM-FO-TFT-TG-AC-O30-AL have DNV certification ! with y: M = FO direct connection multi-mode S = FO direct connection single mode</p>
---	---

7 Marking

Manufacturer	R. STAHL HMI Systems GmbH	
Type code	ET-4x7 / ET-5x7 / ET-6x7	
CE classification:	CE 0158	
Testing authority and certificate number:	BVS 11 ATEX E 102 X	
Ex classification:		
ATEX		II 2(1) G Ex eb q [ia op is Ga] IIC T4 Gb II 2(1) D Ex tb IIIC [ia op is Da] IP65 T110°C Db
IECEx		Ex eb q [ia op is Ga] IIC T4 Gb Ex tb IIIC [ia op is Da] IP65 T110°C Db
NEC		Class I, Zone 1 AEx e q [ia] IIC T4 Gb Class I, Division 2, Groups A, B, C, D (according to NEC 501.5)
CE-Code		Ex e q [ia] IIC T4 Gb Class I, Division 2, Groups A, B, C, D (according to CEC J18-150)
PESO		Ex eb q [ia op is Ga] IIC T4 Gb
CCC		Ex eb q [ia op is Ga] IIC T4 Gb Ex tb [ia op is Da] IIIC T110°C Db
CNEEx		Ex e q [ia op is Ga] IIC T4 Gb Ex tD [iaD op is] A21 IP65 T110°C
KCS		Ex e q IIC T4 Ex tb IIIC IP64 T110°C Ex ia IIC T4 Ex ia IIIB T110°C

8 Power supply

8.1 HMI devices

Power supply:	24 VDC or 100 – 240 VAC, 50 – 60 Hz	
max. power consumption:	at 24 VDC	max. 3 A
	at 100 - 240 VAC	max. 1 A

9 Permitted maximum values

9.1 External, non-intrinsically safe circuits

Input voltage "PWR" (X10):

Nominal voltage:	20 ...240 VAC/VDC (depending on type)
Power consumption I_{max}	≤ 5 A
Power P_{max}	≤ 150 W
Max. operating voltage U_m	≤ 250 VAC
Short-circuit current I_K	≤ 1500 A

USB (X13):

Rated voltage	5 VAC/VDC (± 10 %)
Max. operating voltage U_m	≤ 250 VAC

12 V (X14):

Rated voltage	12 VAC/VDC (± 10 %)
Power consumption I_{max}	≤ 400 mA
Max. operating voltage U_m	≤ 250 VAC

RS-232 "SER" (X97):

Rated voltage	15 VAC/VDC (± 10 %)
Max. operating voltage U_m	≤ 250 VAC

Video "CAM" (X101):

Rated voltage	5 VAC/VDC (± 10 %)
Max. operating voltage U_m	≤ 250 VAC

Audio "AUD" (X105):

Rated voltage	100 VAC/VDC (± 10 %)
Max. operating voltage U_m	≤ 250 VAC

Copper Ethernet (CAT7 1) (X16):

Rated voltage	5 VAC/VDC (± 10 %)
Max. operating voltage U_m	≤ 250 VAC

9.2 External inherently safe optical interface

Ethernet optical fiber (FO 1) (X18)

Multi-mode

Wavelength	850 nm
Radiant power	0.22 mW
max. radiant power:	35 mW

Single mode

Wavelength	1310 nm
Radiant power	0.22 mW
max. radiant power:	35 mW

9.3 External intrinsically safe circuits

Keyboard (X11)

The maximum values are:

U_i	=	5.5	V		U_o	=	5.5	V
I_i	=	3	A		I_o	=	309	mA
P_i	=	2	W		P_o	=	629	mW
C_i	=	negligible	μ F		C_o	=	50	μ F
L_i	=	negligible	mH		L_o	=	40	μ H

Pointer device (X12):

The maximum values are:

U_i	=	5.5	V		U_o	=	5.5	V
I_i	=	3	A		I_o	=	309	mA
P_i	=	2	W		P_o	=	629	mW
C_i	=	negligible	μ F		C_o	=	50	μ F
L_i	=	negligible	mH		L_o	=	40	μ H

USB1i (X24):

The maximum values are:

U_i	=	5.5	V		U_o	=	5.5	V
I_i	=	3	A		I_o	=	309	mA
P_i	=	2	W		P_o	=	629	mW
C_i	=	negligible	μ F		C_o	=	50	μ F
L_i	=	negligible	mH		L_o	=	40	μ H

USB2i (X25):

The maximum values are:

U_i	=	5.5	V		U_o	=	5.5	V
I_i	=	3	A		I_o	=	309	mA
P_i	=	2	W		P_o	=	629	mW
C_i	=	negligible	μ F		C_o	=	50	μ F
L_i	=	negligible	mH		L_o	=	40	μ H

10 Type code

10.1 Standard

10.1.1 ET-4x7 (Panel PC)

! NOTICE	These versions apply to all Panel PC's up to hardware revision 01.03.00, with ATOM™ N270 processor.
-----------------	---

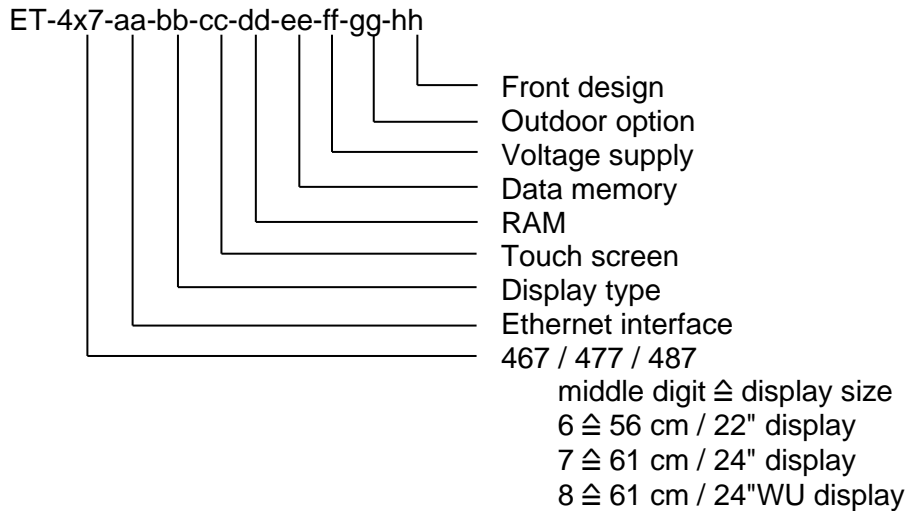

Device variant:

Classification product key	Description
	Type with
ET-4x7- SX -bb-cc-dd-ee-ff-gg-hh	Optical fiber Ethernet interface 1000Base-SX (Ex op is), multi-mode
ET-4x7- TX -bb-cc-dd-ee-ff-gg-hh	Copper Ethernet interface 10/100Base-TX (Ex e)
ET-4x7-aa- TFT -cc-dd-ee-ff-gg-hh	TFT display (standard)
ET-4x7-aa-bb- T -dd-ee-ff-gg-hh	Touch screen (membrane)
ET-4x7-aa-bb- TG -dd-ee-ff-gg-hh	Touch screen glass
ET-4x7-aa-bb-cc- R1 -ee-ff-gg-hh	1 GB RAM
ET-4x7-aa-bb-cc- R2 -ee-ff-gg-hh	2 GB RAM
ET-4x7-aa-bb-cc-dd- 4GB -ff-gg-hh	4 GB Solid State Drive
ET-4x7-aa-bb-cc-dd- 16GB -ff-gg-hh	16 GB Solid State Drive
ET-4x7-aa-bb-cc-dd- 128GBM -ff-gg-hh	128 GB Solid State Drive MLC
ET-4x7-aa-bb-cc-dd- 128GBS -ff-gg-hh	128 GB Solid State Drive SLC
ET-4x7-aa-bb-cc-dd- 100GB -ff-gg-hh	100 GB hard disk (internal)
ET-4x7-aa-bb-cc-dd-ee- AC -gg-hh	Power supply 100 - 240 VAC, 50 - 60 Hz
ET-4x7-aa-bb-cc-dd-ee- DC -gg-hh	Voltage supply 24 VDC
ET-4x7-aa-bb-cc-dd-ee-ff- O30 -hh	Outdoor installation -30 °C [-22 °F] *
ET-4x7-aa-bb-cc-dd-ee-ff-gg- AL	Aluminium front plate
ET-4x7-aa-bb-cc-dd-ee-ff-gg- RM	Rear mount module

! NOTICE	* The O30 option is only available for AC devices !
-----------------	---

10.1.2 ET-4x7-*-BT (Panel PC)

NOTICE

These versions apply to all Panel PC's starting from hardware revision 01.03.01, with Bay Trail ATOM™ E3845 processor.

ET-4x7-aa-BT-bb-cc-dd-ee-ff-gg-hh-ii

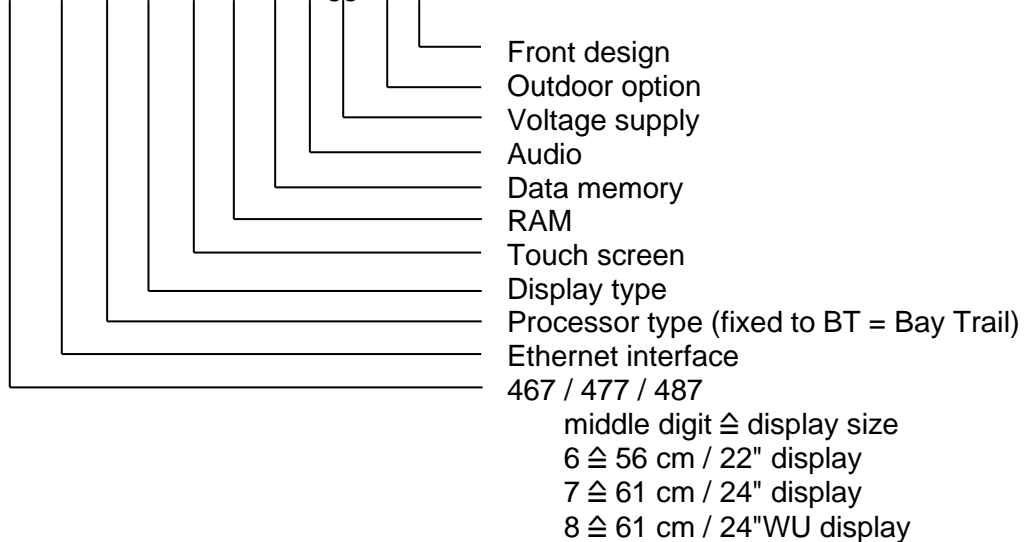

Device variant:

Classification product key	Description
	Type with
ET-4x7- SX -BT-bb-cc-dd-ee-ff-gg-hh-ii	Optical fiber Ethernet interface 1000Base-SX (Ex op is), multi-mode Additional with 1x copper Ethernet interface 10/100/1000Base-TX up from HW-Rev. 01.03.02
ET-4x7- LX -BT-bb-cc-dd-ee-ff-gg-hh-ii	Optical fiber Ethernet interface 1000Base-LX (Ex op is), single mode Additional with 1x copper Ethernet interface 10/100/1000Base-TX up from HW-Rev. 01.03.02
ET-4x7- TX -BT-bb-cc-dd-ee-ff-gg-hh-ii	Copper Ethernet interface 10/100Base-TX (Ex e)
ET-4x7- 2TX -BT-bb-cc-dd-ee-ff-gg-hh-ii	2x Copper Ethernet interface 10/100Base-TX (Ex e)
ET-4x7-aa-BT- TFT -cc-dd-ee-ff-gg-hh-ii	TFT display (standard)
ET-4x7-aa-BT-bb- T -dd-ee-ff-gg-hh-ii	Touch screen (membrane)
ET-4x7-aa-BT-bb- TG -dd-ee-ff-gg-hh-ii	Touch screen glass
ET-4x7-aa-BT-bb-cc- R3 -ee-ff-gg-hh-ii	4 GB RAM
ET-4x7-aa-BT-bb-cc-dd- 64GB -ff-gg-hh-ii	64 GB Solid State Drive
ET-4x7-aa-BT-bb-cc-dd- 128GB -ff-gg-hh-ii	128 GB Solid State Drive
ET-4x7-aa-BT-bb-cc-dd-ee- SND -gg-hh-ii	Audio amplifier (mono amplifier) 3.5 W
ET-4x7-aa-BT-bb-cc-dd-ee-ff- AC -hh-ii	Power supply 100 - 240 VAC, 50 - 60 Hz
ET-4x7-aa-BT-bb-cc-dd-ee-ff- DC -hh-ii	Voltage supply 24 VDC
ET-4x7-aa-BT-bb-cc-dd-ee-ff-gg- O30 -ii	Outdoor installation -30 °C [-22 °F] *
ET-4x7-aa-BT-bb-cc-dd-ee-ff-gg-hh- AL	Aluminium front plate
ET-4x7-aa-BT-bb-cc-dd-ee-ff-gg-hh- RM	Rear mount module

NOTICE

* The O30 option is only available for AC devices !

10.1.3 ET-477-*-P2 (Panel PC)

 NOTICE	These versions apply to all Panel PC's starting from hardware revision 01.03.04, with AMD GX processor.
---	---

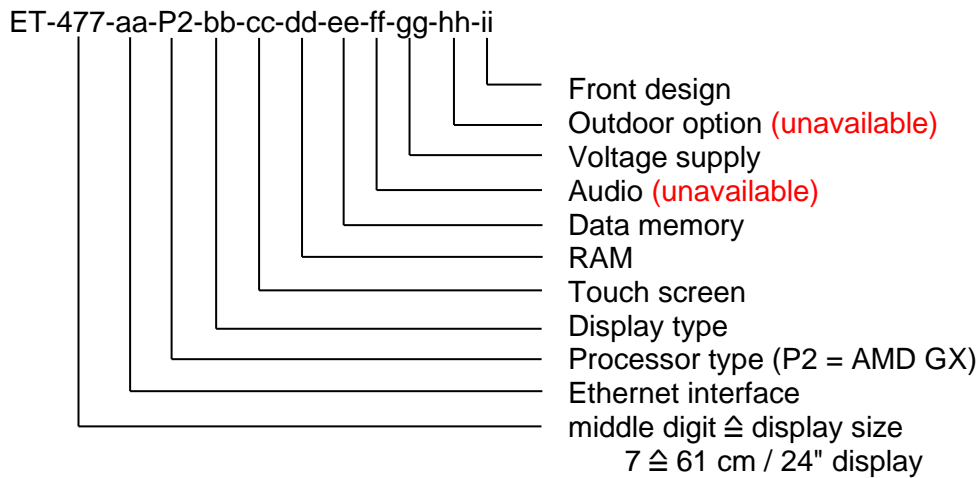

Device variant:

Classification product key	Description
	Type with
ET-477- 2TX -P2-bb-cc-dd-ee-ff-gg-hh-ii	2x Copper Ethernet interface 10/100Base-TX (Ex e)
ET-477- SX -P2-bb-cc-dd-ee-ff-gg-hh-ii	Optical fiber Ethernet interface 1000Base-SX (Ex op is), multi-mode, additional 1x copper Ethernet interface 10/100/1000Base-TX
ET-477- LX -P2-bb-cc-dd-ee-ff-gg-hh-ii	Optical fiber Ethernet interface 1000Base-LX (Ex op is), single mode, additional 1x copper Ethernet interface 10/100/1000Base-TX
ET-477-aa-P2- TFT -cc-dd-ee-ff-gg-hh-ii	TFT display (standard)
ET-477-aa-P2-bb- T -dd-ee-ff-gg-hh-ii	Touch screen (membrane)
ET-477-aa-P2-bb- TG -dd-ee-ff-gg-hh-ii	Touch screen glass
ET-477-aa-P2-bb-cc- R3 -ee-ff-gg-hh-ii	4 GB RAM
ET-477-aa-P2-bb-cc-dd- 64GB -ff-gg-hh-ii	64 GB Solid State Drive
ET-477-aa-P2-bb-cc-dd- 128GB -ff-gg-hh-ii	128 GB Solid State Drive
ET-477-aa-P2-bb-cc-dd-ee-ff- AC -hh-ii	Power supply 100 - 240 VAC, 50 - 60 Hz
ET-477-aa-P2-bb-cc-dd-ee-ff- DC -hh-ii	Voltage supply 24 VDC
ET-477-aa-P2-bb-cc-dd-ee-ff-gg-hh- AL	Aluminium front plate

10.1.4 ET-477-*-PB (Panel PC)

NOTICE

These versions apply to all Panel PC's starting from hardware revision 01.03.08, with Intel® ATOM™ E3940 processor.

ET-477-aa-PB-bb-cc-dd-ee-ff-gg-hh-ii

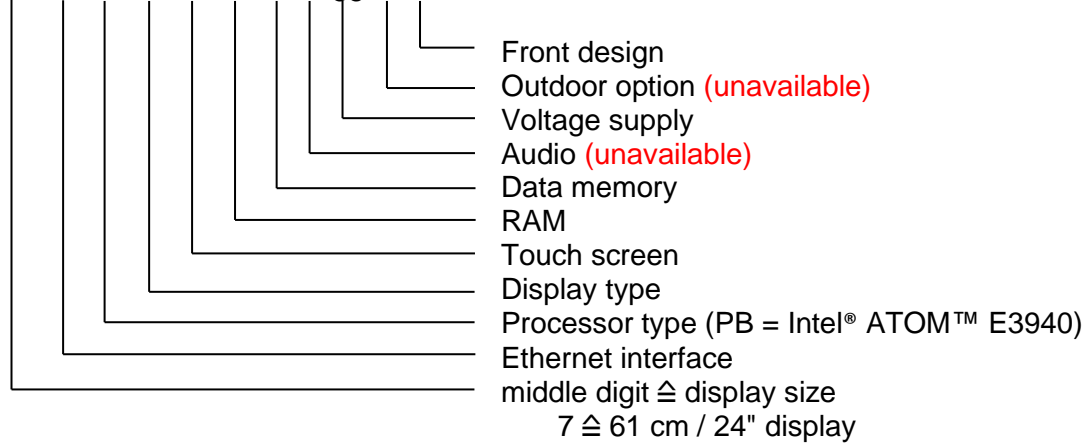

Device variant:

Classification product key	Description
	Type with
ET-477- 2TX -PB-bb-cc-dd-ee-ff-gg-hh-ii	2x Copper Ethernet interface 10/100Base-TX (Ex e)
ET-477- SX -PB-bb-cc-dd-ee-ff-gg-hh-ii	Optical fiber Ethernet interface 1000Base-SX (Ex op is), multi-mode, additional 1x copper Ethernet interface 10/100/1000Base-TX
ET-477- LX -PB-bb-cc-dd-ee-ff-gg-hh-ii	Optical fiber Ethernet interface 1000Base-LX (Ex op is), single mode, additional 1x copper Ethernet interface 10/100/1000Base-TX
ET-477-aa-PB- TFT -cc-dd-ee-ff-gg-hh-ii	TFT display (standard)
ET-477-aa-PB-bb- T -dd-ee-ff-gg-hh-ii	Touch screen (membrane)
ET-477-aa-PB-bb- TG -dd-ee-ff-gg-hh-ii	Touch screen glass
ET-477-aa-PB-bb-cc- R3 -ee-ff-gg-hh-ii	4 GB RAM
ET-477-aa-PB-bb-cc-dd- 64GB -ff-gg-hh-ii	64 GB Solid State Drive
ET-477-aa-PB-bb-cc-dd- 128GB -ff-gg-hh-ii	128 GB Solid State Drive
ET-477-aa-PB-bb-cc-dd-ee-ff- AC -hh-ii	Power supply 100 - 240 VAC, 50 - 60 Hz
ET-477-aa-PB-bb-cc-dd-ee-ff- DC -hh-ii	Voltage supply 24 VDC
ET-477-aa-PB-bb-cc-dd-ee-ff-gg-hh- AL	Aluminium front plate

10.1.5 ET-5x7 (Thin Client)

 NOTICE	These versions apply to all Thin Client's up to hardware revision 01.03.00, with AMD Geode LX processor.
---	--

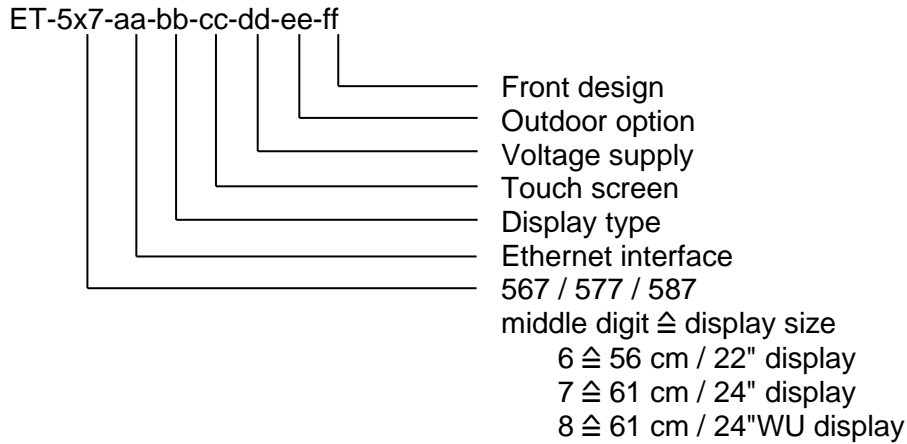

Device variant:

Classification product key	Description
	Type with
ET-5x7- SX -bb-cc-dd-ee-ff	Optical fiber Ethernet interface 1000Base-SX (Ex op is), multi-mode
ET-5x7- TX -bb-cc-dd-ee-ff	Copper Ethernet interface 10/100Base-TX (Ex e)
ET-5x7-aa- TFT -cc-dd-ee-ff	TFT display (standard)
ET-5x7-aa-bb- T -dd-ee-ff	Touch screen (membrane)
ET-5x7-aa-bb- TG -dd-ee-ff	Touch screen glass
ET-5x7-aa-bb-cc- AC -ee-ff	Power supply 100 - 240 VAC, 50 - 60 Hz
ET-5x7-aa-bb-cc- DC -ee-ff	Voltage supply 24 VDC
ET-5x7-aa-bb-cc-dd- O30 -ff	Outdoor installation -30 °C [-22 °F] *
ET-5x7-aa-bb-cc-dd-ee- AL	Aluminium front plate
ET-5x7-aa-bb-cc-dd-ee- RM	Rear mount module

 NOTICE	* The O30 option is only available for AC devices !
---	---

10.1.6 ET-5x7-*-BT (Thin Client)

! NOTICE	These versions apply to all Thin Client's starting from hardware revision 01.03.01, with Bay Trail ATOM™ E3845 processor.
-----------------	---

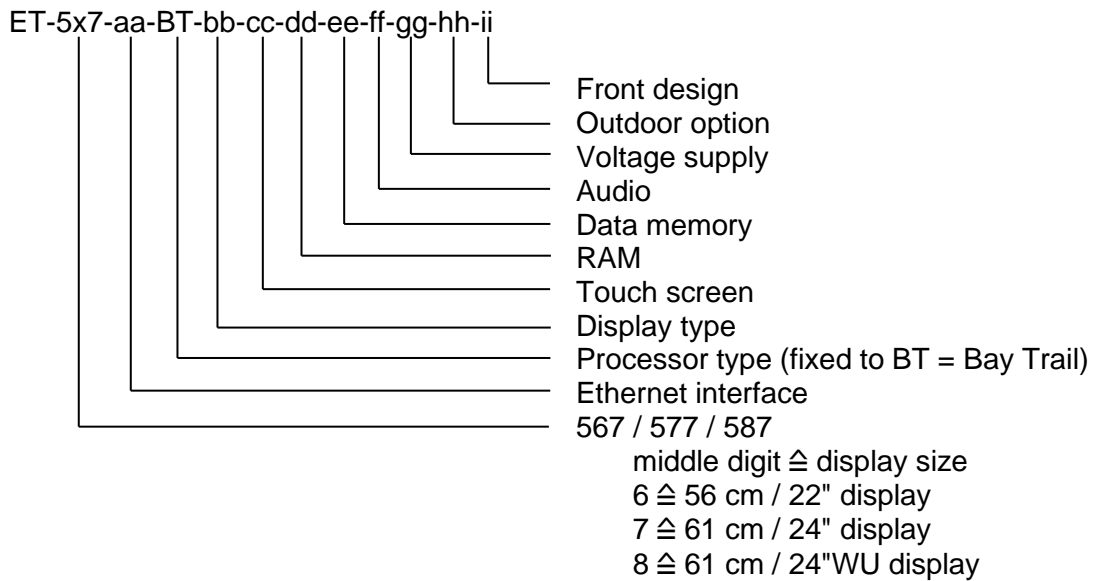

Device variant:

Classification product key	Description
	Type with
ET-5x7- SX -BT-bb-cc-dd-ee-ff-gg-hh-ii	Optical fiber Ethernet interface 1000Base-SX (Ex op is), multi-mode Additional with 1x copper Ethernet interface 10/100/1000Base-TX up from HW-Rev. 01.03.02
ET-5x7- LX -BT-bb-cc-dd-ee-ff-gg-hh-ii	Optical fiber Ethernet interface 1000Base-LX (Ex op is), single mode Additional with 1x copper Ethernet interface 10/100/1000Base-TX up from HW-Rev. 01.03.02
ET-5x7- TX -BT-bb-cc-dd-ee-ff-gg-hh-ii	Copper Ethernet interface 10/100Base-TX (Ex e)
ET-5x7- 2TX -BT-bb-cc-dd-ee-ff-gg-hh-ii	2x Copper Ethernet interface 10/100Base-TX (Ex e)
ET-5x7-aa-BT- TFT -cc-dd-ee-ff-gg-hh-ii	TFT display (standard)
ET-5x7-aa-BT-bb- T -dd-ee-ff-gg-hh-ii	Touch screen (membrane)
ET-5x7-aa-BT-bb- TG -dd-ee-ff-gg-hh-ii	Touch screen glass
ET-5x7-aa-BT-bb-cc- R3 -ee-ff-gg-hh-ii	4 GB RAM
ET-5x7-aa-BT-bb-cc-dd- 64GB -ff-gg-hh-ii	64 GB Solid State Drive
ET-5x7-aa-BT-bb-cc-dd- 128GB -ff-gg-hh-ii	128 GB Solid State Drive
ET-5x7-aa-BT-bb-cc-dd-ee- SND -gg-hh-ii	Audio amplifier (mono amplifier) 3.5 W
ET-5x7-aa-BT-bb-cc-dd-ee-ff- AC -hh-ii	Power supply 100 - 240 VAC, 50 - 60 Hz
ET-5x7-aa-BT-bb-cc-dd-ee-ff- DC -hh-ii	Voltage supply 24 VDC
ET-5x7-aa-BT-bb-cc-dd-ee-ff-gg- O30 -ii	Outdoor installation -30 °C [-22 °F] *
ET-5x7-aa-BT-bb-cc-dd-ee-ff-gg-hh- AL	Aluminium front plate
ET-5x7-aa-BT-bb-cc-dd-ee-ff-gg-hh- RM	Rear mount module

! NOTICE	* The O30 option is only available for AC devices !
-----------------	---

10.1.7 ET-577-*-P2 (Thin Client)

 NOTICE	These versions apply to all Thin Client's starting from hardware revision 01.03.04, with AMD GX processor.
---	--

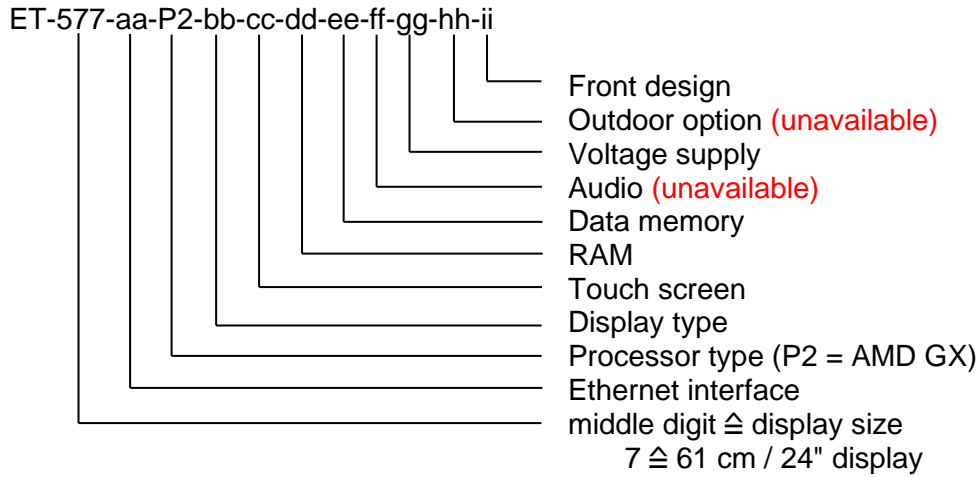

Device variant:

Classification product key	Description
	Type with
ET-577- 2TX -P2-bb-cc-dd-ee-ff-gg-hh-ii	2x Copper Ethernet interface 10/100Base-TX (Ex e)
ET-577- SX -P2-bb-cc-dd-ee-ff-gg-hh-ii	Optical fiber Ethernet interface 1000Base-SX (Ex op is), multi-mode, additional 1x copper Ethernet interface 10/100/1000Base-TX
ET-577- LX -P2-bb-cc-dd-ee-ff-gg-hh-ii	Optical fiber Ethernet interface 1000Base-LX (Ex op is), single mode, additional 1x copper Ethernet interface 10/100/1000Base-TX
ET-577-aa-P2- TFT -cc-dd-ee-ff-gg-hh-ii	TFT display (standard)
ET-577-aa-P2-bb- T -dd-ee-ff-gg-hh-ii	Touch screen (membrane)
ET-577-aa-P2-bb- TG -dd-ee-ff-gg-hh-ii	Touch screen glass
ET-577-aa-P2-bb-cc- R3 -ee-ff-gg-hh-ii	4 GB RAM
ET-577-aa-P2-bb-cc-dd- 64GB -ff-gg-hh-ii	64 GB Solid State Drive
ET-577-aa-P2-bb-cc-dd- 128GB -ff-gg-hh-ii	128 GB Solid State Drive
ET-577-aa-P2-bb-cc-dd-ee-ff- AC -hh-ii	Power supply 100 - 240 VAC, 50 - 60 Hz
ET-577-aa-P2-bb-cc-dd-ee-ff- DC -hh-ii	Voltage supply 24 VDC
ET-577-aa-P2-bb-cc-dd-ee-ff-gg-hh- AL	Aluminium front plate

10.1.8 ET-577-*-PB (Thin Client)

NOTICE

These versions apply to all Thin Client's starting from hardware revision 01.03.08, with Intel® ATOM™ E3940 processor.

ET-577-aa-PB-bb-cc-dd-ee-ff-gg-hh-ii

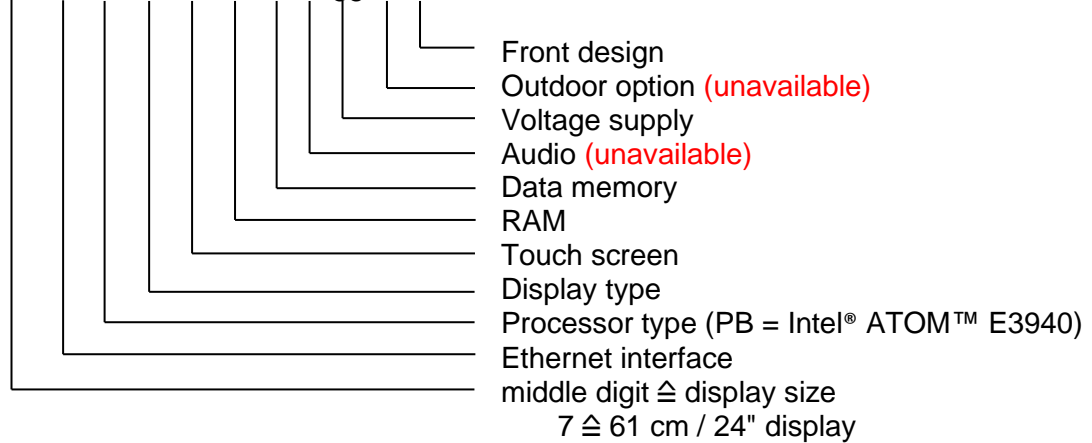

Device variant:

Classification product key	Description
	Type with
ET-577- 2TX -PB-bb-cc-dd-ee-ff-gg-hh-ii	2x Copper Ethernet interface 10/100Base-TX (Ex e)
ET-577- SX -PB-bb-cc-dd-ee-ff-gg-hh-ii	Optical fiber Ethernet interface 1000Base-SX (Ex op is), multi-mode, additional 1x copper Ethernet interface 10/100/1000Base-TX
ET-577- LX -PB-bb-cc-dd-ee-ff-gg-hh-ii	Optical fiber Ethernet interface 1000Base-LX (Ex op is), single mode, additional 1x copper Ethernet interface 10/100/1000Base-TX
ET-577-aa-PB- TFT -cc-dd-ee-ff-gg-hh-ii	TFT display (standard)
ET-577-aa-PB-bb- T -dd-ee-ff-gg-hh-ii	Touch screen (membrane)
ET-577-aa-PB-bb- TG -dd-ee-ff-gg-hh-ii	Touch screen glass
ET-577-aa-PB-bb-cc- R3 -ee-ff-gg-hh-ii	4 GB RAM
ET-577-aa-PB-bb-cc-dd- 64GB -ff-gg-hh-ii	64 GB Solid State Drive
ET-577-aa-PB-bb-cc-dd- 128GB -ff-gg-hh-ii	128 GB Solid State Drive
ET-577-aa-PB-bb-cc-dd-ee-ff- AC -hh-ii	Power supply 100 - 240 VAC, 50 - 60 Hz
ET-577-aa-PB-bb-cc-dd-ee-ff- DC -hh-ii	Voltage supply 24 VDC
ET-577-aa-PB-bb-cc-dd-ee-ff-gg-hh- AL	Aluminium front plate

10.1.9 ET-6x7 KVM System

ET-6x7-aa-bb-cc-dd-ee-ff-gg

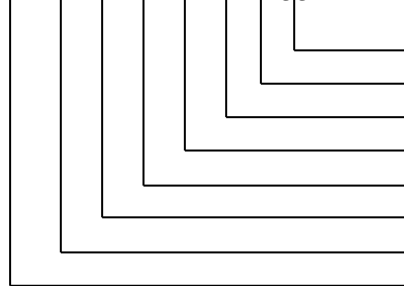

- Front design
- Outdoor option
- Voltage supply
- Audio
- Touch screen
- Display type
- Transfer technology

667 / 677 / 687
 middle digit $\hat{=}$ display size
 6 $\hat{=}$ 56 cm / 22" display
 7 $\hat{=}$ 61 cm / 24" display
 8 $\hat{=}$ 61 cm / 24"WU display

Device variant:

Classification product key	Description
	Type with
ET-6x7- DVI1-CAT -bb-cc-dd-ee-ff-gg	DVI1 KVM, with direct copper connection, Gigabit (Ex e)
ET-6x7- DVI1-MM -bb-cc-dd-ee-ff-gg	DVI1 KVM, with direct optical fiber connection (Ex op is), multi-mode
ET-6x7- DVI1-SM -bb-cc-dd-ee-ff-gg	DVI1 KVM, with direct optical fiber connection (Ex op is), single mode
ET-667- DVI2-CAT -bb-cc-dd-ee-ff-gg	DVI2 ** KVM, with direct copper connection, Gigabit (Ex e)
ET-6x7- DVI3-CAT -bb-cc-dd-ee-ff-gg	DVI3 KVM, with direct copper connection, Gigabit (Ex e)
ET-6x7- DVI3-MM-FO -bb-cc-dd-ee-ff-gg	DVI3 KVM, with direct optical fiber connection (Ex op is), multi-mode
ET-6x7- DVI3-SM-FO -bb-cc-dd-ee-ff-gg	DVI3 KVM, with direct optical fiber connection (Ex op is), single mode
ET-6x7-aa- TFT -cc-dd-ee-ff-gg	TFT display (standard)
ET-6x7-aa-bb- T -dd-ee-ff-gg	Touch screen (membrane)
ET-6x7-aa-bb- TG -dd-ee-ff-gg	Touch screen glass
ET-6x7-aa-bb-cc- SND -ee-ff-gg	Audio amplifier (mono amplifier) 3.5 W
ET-6x7-aa-bb-cc-dd- AC -ff-gg	Power supply 100 - 240 VAC, 50 - 60 Hz
ET-6x7-aa-bb-cc-dd- DC -ff-gg	Voltage supply 24 VDC
ET-6x7-aa-bb-cc-dd-ee- O30 -gg	Outdoor installation -30 °C [-22 °F] *
ET-6x7-aa-bb-cc-dd-ee-ff- AL	Aluminium front plate
ET-6x7-aa-bb-cc-dd-ee-ff- RM	Rear end module

 NOTICE	* The O30 option is only available for AC devices !
	** The DVI2 KVM solution is only available together with the ET-667 HMI device !

10.2 Type code representation for China

10.2.1 ET-xx7 (Panel PC / Thin Client)

ET-ab7-c-d-e-f-g-h-i-j-k-l-m

ET	a	b	7	c	d	e	f	g	h	i	j	k	l	m
ET	4	6	7	TX	BT	TFT	00	R3	64GB	000	AC	000	AL	000
	5	7		2TX	P2		T		128GB	SND	DC	030	RM	SIE
		8		SX			TG						VA	
				LX										

a = Technology

4 = Panel PC

5 = Thin Client

b = Display size

6 = 56 cm / 22" Display

7 = 61 cm / 24" Display

8 = 61 cm / 24"WU Display

7 = HMI Series

7 = xx7 HMI Series

c = Ethernet interface

TX = 1x Copper Ethernet interface 10/100Base-TX

2TX = 2x Copper Ethernet interface 10/100Base-TX

SX = Optical fiber Ethernet interface 1000Base-SX (Ex op is), multi-mode

LX = Optical fiber Ethernet interface 1000Base-LX (Ex op is), single mode

d = Prozessor type

BT = Bay Trail

P2 = AMD GX

e = Display type

TFT = TFT Display (Standard)

f = Touch screen

00 = No touch

T = Touch screen (membrane)

TG = Touch screen glass

g = RAM size

R3 = 4 GB RAM

h = Solid state drive

64GB = 64 GB solid state drive

128GBM = 128 GB solid state drive MLC

i = Audio option

000 = Standard installation (no audio)

SND = Audio amplifier (mono amplifier) 3.5 W

j = Power supply

AC = Power supply 100-240 VAC, 50-60 Hz

DC = Power supply 24 VDC

k = Outdoor installation

000 = Standard installation

O30 = Outdoor installation -30 °C (The O30 option is only available for AC devices)

l = Front design

AL = Aluminium front plate

RM = Rear mount module

VA = Stainless steel 1,4301 front plate

m = Design

000 = Standard design

SIE = Siemens design

10.2.2 ET-6x7 (KVM Systems)

ET-6a7-b-c-d-e-f-g-h-i

ET	6	a	7	b	c	d	e	f	g	h	i
ET	6	6	7	DVI1-CAT	TFT	00	000	AC	000	AL	000
		7		DVI1-MM		T	SND	DC	030	RM	SIE
		8		DVI1-SM		TG				VA	
				DVI2-CAT							
				DVI3-CAT							
				DVI3-MM-FO							
				DVI3-SM-FO							

6 = Technology

6 = KVM Systems

a = Display size

6 = 56 cm / 22" Display

7 = 61 cm / 24" Display

8 = 61 cm / 24"WU Display

7 = HMI Series

7 = xx7 HMI Series

b = Transfer technology

DVI1-CAT = DVI1 KVM, direct copper connection, Gigabit

DVI1-MM = DVI1 KVM, direct optical fiber connection (Ex op is), multi-mode

DVI1-SM = DVI1 KVM, direct optical fiber connection (Ex op is), single mode

DVI2-CAT = DVI2 KVM, direct copper connection, Gigabit

DVI3-CAT = DVI3 KVM, direct copper connection, Gigabit

DVI3-MM-FO = DVI3 KVM, direct optical fiber connection (Ex op is), multi-mode

DVI3-SM-FO = DVI3 KVM, direct optical fiber connection (Ex op is), single mode

c = Display type

TFT = TFT display (standard)

d = Touch screen

00 = No touch

T = Touch screen (membrane)

TG = Touch screen glass

e = Audio option

000 = Standard installation (no audio)

SND = Audio amplifier (mono amplifier) 3.5 W

f = Power supply

AC = Power supply 100-240 VAC, 50-60 Hz

DC = Power supply 24 VDC

g = Outdoor installation

000 = Standard installation

O30 = Outdoor installation -30 °C (The O30 option is only available for AC devices)

h = Front design

AL = Aluminium front plate

RM = Rear mount module

VA = Stainless steel 1,4301 front plate

i = Design

000 = Standard design

SIE = Siemens design

11 Safety information

**CAUTION**

The notes listed in section 11. must be heeded to avoid injury and damage to equipment !

11.1 General Safety Information

- All relevant accident prevention regulations and the rules for electric installations have to be observed during installation, maintenance and operations. All persons involved in installation, commission, maintenance and repairs of this device and its accessories must be qualified accordingly and must have familiarised themselves with this manual and any associated documentation.
- In case of non-compliance or contravention of the above explosion-protection is no longer guaranteed and all warranty claims shall be null and void.
- National safety and accident prevention rules apply.
- Use the device for its intended purpose only.
- No changes to the device are permitted. The enclosure may only be opened by R. STAHL HMI Systems GmbH.

**ATTENTION**

For reasons of explosion protection, there is, due to the design, a small gap between the touch surface and the cover. Therefore, the devices should not be used in high pollution environments !

Under conditions of high pollution the manufacturers understand areas in which solid particles, smaller than 100 µm, form sludge and incrustations and thus can clog the gap.

11.2 Cautionary note

**ATTENTION**

This is an EN 55022 Class A product.

In a domestic environment this product may cause radio interference in which case the user may be required to take adequate measures.

11.3 Installation safety information

- The in each case valid national assembly and installation rules and the generally accepted technical rules must be observed. The device and its accessories must be connected and operated according to applicable standards, directives and installation guidelines. Only qualified personnel or personnel that has been instructed accordingly are allowed to install the device.
- The HMI device has been certified as a fixed installed device. It must be fixed with a bracket or be secured in another way at a specified position.
- The HMI device must be disconnected from the mains for a change of position. The EPL must be adhered to.
- The HMI device's front should be protected by a canopy against permanent exposure to UV light. This increases the front membrane's lifespan. The canopy **MUST NOT** be too close to the front plate and sufficient air circulation must be ensured.
- Only appropriate tools must be used for the installation.
- According to IEC 60950, a suitable, easily accessible circuit breaker must be installed outside of the xx7 (version AC) which can cut the power line.
- The screws on the lid of the Ex e connection box must be fastened with a torque of 1 Nm.

- The cable connections of the connection box must be in line with country-specific regulations and may have to be adapted accordingly. Potential changes to the ambient parameters such as temperature must be taken into account.
- The cable entries in the connection box must have ingress protection IP66 or may have to be adapted to meet country-specific requirements. The pre-assembled cable entry threads are:
 - 2x M16x1,5
 - 1x M20x1,5
 - 3x M25x1,5The wall of the terminal box where the cable entries are mounted has a thickness of at least 4 mm.
- The cable connections must be tightened fast according to regulations. Unused cable connections must be sealed with appropriate blind plugs. Only permanently laid cables may be connected to the pre-mounted ATEX cable connections.
- The outer cable diameters must correspond to the cable connection specifications.
 - Cable entry M16 for round cable, outside cable cross-section 4...8 mm (0.16"...0.31") or 5...10 mm (0.197"...0.39")
 - Cable entry M20 for round cable, outside cable cross-section 6...12 mm (0.24"...0.47")
 - Cable entry M25 for round cable, outside cable cross-section 14...18 mm (0.55"...0.71")
- The HMI device must not be opened, maintained or repaired in hazardous atmospheres (sole exception: the Ex e connection box).
- Before opening the Ex e connection box, ensure that all Ex e and Ex i circuits are fully de-energised and isolated. You must also ensure that the power supply circuit is isolated. The cable diameter must meet the terminal specifications. The Ex e connection box must be tightly sealed.
- All Ex e and Ex i circuits must be completely de-energised before the HMI device is connected. After the Ex e and Ex i circuits have been de-energised, wait for at least seven minutes before opening the Ex e connection box. The Ex e connection box must not be opened if the HMI device is energised.
- The earth / ground (equipotential bonding) connector at the back of the HMI's enclosure must be connected to the equipotential bonding conductor of the hazardous area. The earthing cable must have a minimum cross section of 4 mm² and be fitted properly. To prevent equalizing currents flowing to the earth / ground (equipotential bonding) system of the HMI device it is necessary to safely isolate any connected devices from earth or to integrate them into the earth / ground (equipotential bonding) system of the HMI device.
- We recommend you use screened cables with the HMI device. Routing of the data cable may reduce performance. Cables for intrinsically safe wiring have to pass a test voltage of AC 500 V / DC 750 V. Use the values 200 pF/m and 1 µH/m at unknown cable properties.
- We recommend you use a PG fitting (e.g. UNI_Dicht_HF™) for the screen connection over a large surface of the data cable between the 6x7-KVM-DVI3 transmission unit and the HMI device. In this case, the data cable's scree must not be connected again inside the HMI device at the screen connection rail.
- If display types ET-xx7-DVI1-MM or ET-xx7-DVI1-SM are used, terminal X16 remains unused.
- To establish a secure earthed connection between HMI device and plant and to prevent inadvertent loosening of the cables, each cable with its screen must be connected to the corresponding earthing bracket located in the Ex e connection box close to the associated terminal.

- At the place of installation voltage must not exceed 250 V and short-circuit current must not exceed 1500 A.
- A tick close to the X10 terminal indicates the voltage type (AC / DC). For the 24 VDC types the cable cross-sections depend on the cable length of the voltage supply cable, as follows:

Cable length in metres (ft)	Cable cross-section in mm ² (AWG)
max. 55 m (180 ft)	1.5 mm ² (AWG16)
max. 90 m (295 ft)	2.5 mm ² (AWG14)
max. 150 m (492 ft)	4 mm ² (AWG12)
max. 225 m (738 ft)	6 mm ² (AWG10)
max. 375 m (1230 ft)	10 mm ² (AWG8)
max. 600 m (1968 ft)	16 mm ² (AWG6)

If the cable's cross section is greater than the maximum possible for the terminals, the cable needs to be routed according to regulations via a smaller cable cross section before being inserted into the connection box (possibly using the Ex e terminal box).

- When the interface of intrinsically safe devices / partial intrinsically safe devices was or is connected to not intrinsically safe interfaces, the license will become void and it must be operated as a not intrinsically safe device. If the device was operated on an intrinsically safe interface with a lower level of international protection (e.g. an Ex ia device on an Ex ib interface), it must not be operated afterwards in applications for a higher level of international protection (e.g. Ex ia).
- If the HMI device is being used in a dust atmosphere and must be replaced, the device or the enclosure in which it is mounted must be disconnected from the mains first and then, according to regulations, be left to cool down. Before opening the HMI device or its enclosure and whilst they are open, the environment must be kept dust-free so that no dust can intrude into the inside of the enclosure. When mounting new components please ensure that all seals are undamaged and fit tightly.
- Before starting up the HMI device you must ensure that it has been installed according to regulations and that neither the device nor its cables are damaged.

! ATTENTION	The audio Interface (X105) can handle high voltage up to 100 V. For installation and wiring the national standards must be observed and a properly insulation needed to prevent a hazard.
--------------------	---

11.3.1 Only for HMI devices with DVI3

- The USB interfaces of the ET-6x7-DVI3 devices are only certified for the connection of keyboards and pointer units from R. STAHL HMI Systems GmbH.

11.3.2 HMI installation in enclosures with degree of protection "e" or "t"

If the ET-xx7 HMI devices are mounted inside an enclosure with degree of protection Ex e or Ex t, the mechanical impact protection and the IP of the enclosure (up to IP65) is retained even after the device has been installed. The internal separation requirements and the temperature conditions of the Ex e enclosure must adhere to the applicable directives. The distance between the terminals of the HMI devices and other, insulated, conductive parts (except earth) within the Ex e enclosure must be at least 50 mm.

11.3.3 Conditions of safe use according to CE-Code / NEC / CSA

- Application supporting devices connected to the intrinsically safe input / outputs of connection points X101, X105, X97, X13, X14, and X16 shall be installed in a non-hazardous location (see control drawing 11100024) or must be suitable protected by an explosionproof or Ex p enclosure.
- Connection point X10 shall be connected to a Class 2 supply for the DC model.
- All connections to the display unit shall be installed using a CSA certified or us ULc listed Ex e cable gland suitable for the end installation and shall carry a minimum IP rating of IP65.
- Any non-metallic parts of the HMI device that can accumulate static electricity must be cleaned only with a damp cloth.

11.3.4 Tightening torque

11.3.4.1 Terminals



The stipulated tightening torques of the connection terminals must be observed and applied. Again, they must be checked and possibly adjusted before commissioning !

11.3.4.2 Cable glands

- The tightening torques for the cable glands may vary depending on the cables and wires used. The users have to determine and apply the required torques themselves.
- In the case of ex-factory systems, all components are installed correctly and in accordance with applicable standards. Since storage or temperature etc. can have an impact on the cables and cable glands, the pre-installed screw connections must be checked and possibly tightened before commissioning.
- If they are too loose or too tight, the type of protection, sealing or strain relief might be negatively impacted.
- Cable glands with cap nut and without strain relief clamp should only be used for permanently installed cables and electrical lines. Installation of the required strain relief is the responsibility of the system set-up engineer.

11.4 Industrial Security

Our products with Industrial Security functions support the secure operation of plants, systems and equipment. Protection against cyber threats requires an all-encompassing Industrial Security concept. The key to a successful concept is integrated implementation, continuous maintenance and state-of-the-art technology. This is the responsibility of the plant operator.

The following are key issues for an effective Industrial Security concept:

- Prevention of unauthorised access to plants, systems, equipment and networks
- Systems, equipment and components should only be connected to the company intranet or the internet if and when required
- Employ protective measures such as firewalls and network segmentation
- Only use the latest software product versions
- Carry out software updates as soon as new versions are available
- Use standard user accounts for regular operation

- Use secure passwords
- Appropriate safeguarding of administrator accounts
- Application of security guidelines
- Other measures to be taken as required

R. STAHL uses Windows 10 for its products. It does not develop any cryptographic functions. R. STAHL does not configure / harden the operating system, nor does it provide or refer to security guidelines for doing so.

Furthermore, R. STAHL is constantly working on enhancing its products, thereby contributing to plant security and to minimizing the risk of cyber threats.

11.5 Safety information for operation

- Operate the HMI device only if it is clean and undamaged. If the HMI device is in any way damaged, do not touch it to avoid injury. In the case of any damage that may compromise ingress protection (e.g. cracks, holes or broken components) the HMI device must be taken out of commission immediately. Before the device is recommissioned the damaged components must be replaced.
- If you want to use the device in zone 20, 21 or 22 as EPL Da/Db/Dc, dust deposits of a thickness exceeding 5 mm must be removed and you have to ensure that no high-energy loading mechanisms at the operating surface of the unit (e.g. pneumatic particle transport) occur during operation. The HMI device may not be used in environments where propagating brush discharges may occur.
- In general, and particularly when opening and closing enclosures, users must take care not to get injured by getting caught / trapped.
- In case of non-compliance or contravention of the above explosion-protection is no longer guaranteed and all warranty claims shall be null and void.

11.6 Special conditions

- Along the intrinsically safe circuits between the display unit and pointing device potential equalization must exist.
- The pointing device shall not be used in areas where charging mechanism creating propagating brush discharges have to be regarded.

12 Assembly and disassembly

12.1 General information

 NOTICE	Assembly and disassembly are subject to general technical rules. Additional, specific safety regulations apply to electronic and pneumatic installations.
---	---

12.2 Cut-out ET-xx7

Make a cut-out with the following dimensions:

Width	Height	Depth of cut-out	Material thickness	Unit of measurement
615 ± 0.5	435 ± 0.5	110	up to 5	mm
24.21" ± 0.002"	17.13" ± 0.002"	4.33"	up to 0.02"	inch (")

12.3 Tightening torque

 NOTICE	The tightening torque of the nuts for the fixing bolts of the ET-4x7/5x7/6x7 panel mount devices is 1.2 Nm (+- 0.2 Nm) !
---	---

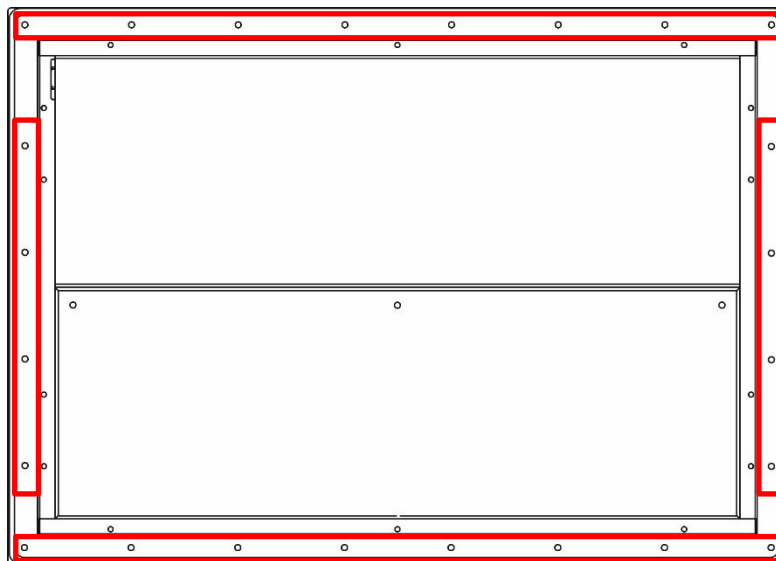

13 Operation

13.1 General information

 NOTICE	<p>When operating the devices, particular care shall be taken that:</p> <ul style="list-style-type: none"> • the HMI device has been properly installed according to instructions, • the HMI device is undamaged, • the terminal compartment is clean, • all screws are tightened fast, • before switching the HMI device on, its external equipotential bonding terminal is properly connected to the equipotential bonding system at its place of use, • the cover of the terminal compartment is completely closed.
---	--

13.2 Connections

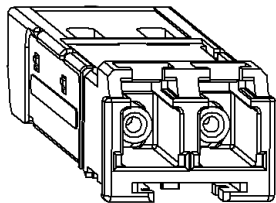
Terminal	Pin	Definition / typical cable color				Connection	
X10 PWR	1	Power supply HMI device +24 VDC or 100 - 240 VAC				Power supply of the HMI device Ex e	
	2	Power supply HMI device 0 VDC or 100 - 240 VAC					
	3	Earth connection					
X11 KBi	1	+UB		Red		USB interface Ex ia for External keyboard	
	2	D-		White			
	3	D+		Green			
	4	GND		Black			
X12 Mi	1	+UB		Red		USB interface Ex ia for Mouse	
	2	D-		White			
	3	D+		Green			
	4	GND		Black			
X13	1	+UB		Red		USB Ex e	
	2	D-		White			
	3	D+		Green			
	4	GND		Black			
X14	1	+12 V		Red		12 VDC output Ex e, max. 500 mA	
	2	GND		Black			
X16 CAT7 / CAT5 Data						Ethernet copper connection * Ex e either * TX or 2TX (2TX not for 600 SERIES)	
	1	TRD0+	TxD + 1	White / Orange	White / Orange 1		TX1
	2	TRD0-	TxD - 1	Orange	Orange 1		
	3	TRD1+	RxD + 1	White / Green	White / Green 1		
	4	TRD1-	RxD - 1	Green	Green 1		
	5	TRD2+	TxD + 2	Blue / White	White / Orange 2		TX2
	6	TRD2-	TxD - 2	Blue	Orange 2		
	7	TRD3+	RxD + 2	White / Brown	White / Green 2		
8	TRD3-	RxD - 2	Brown	Green 2			
9	SHLD	SHLD	Screen	Screen			
X18 FO 1 Data		 <p>Optical fiber connection type LC Duplex connector</p> <p style="text-align: center;">Tx Rx</p>				Ethernet optical fiber interface * Ex op is	

X24 USB1i	1	+UB	Red	USB interface Ex ia
	2	D-	White	
	3	D+	Green	
	4	GND	Black	
X25 USB2i	1	+UB	Red	USB interface ** Ex ia
	2	D-	White	
	3	D+	Green	
	4	GND	Black	
X97 SER	1	TxD	Blue / White	Serial Ex e interface RS-232
	2	RxD	Blue	
	3	RTS	White / Orange	
	4	CTS	Orange	
	5	GND	Black	
X101 CAM	1	Signal FBAS	White	Video Ex e interface (optional) not for ET-x77-*-P2 or ET-x77-*-PB devices
	2	Screen (GND)	Black	
X105 AUD	1	CH1 / line out left	Red	Audio Ex e interface (Line in only 600 SERIES) Audio not for ET-x77-*-PB devices
	2	CH2 / line out right	Black	
	3	CH3 / line in left	Red	
	4	CH4 / line in right	Black	
	5	GND	Black	
or				
X105 AUD	1	LS1+	Red	Audio sound Ex e interface (optional) not for ET-x77-*-P2 or ET-x77-*-PB devices
	2	LS1-	Black	
	3	LS2+	Red	
	4	LS2-	Black	
	5	GND	Black	

 NOTICE

The following applies to all terminals:

0.2 - 2.5 mm² / AWG24 - AWG14 for flexible cable

0.2 - 4 mm² / AWG24 - AWG12 for rigid cable

Strip cable of 7 mm (0.28 in) insulation

max. one cable per terminal

Recommended cable length for terminals X11, X12, X13, X14, X24, X25:

max. 3 m (10 ft)

- * Please note that the Ethernet connection is **either** for an optical fiber connection (X18) **or** for a copper connection (X16), depending on the version ordered !

Up from HW-Rev. 01.03.02, all ET-4x7 and ET-5x7 devices with SX and LX Ethernet interface are fitted additional with an Ethernet TX interface !

The option 2TX is only possible at devices with Bay Trail (BT), AMD and E3940 processor and **NOT** at 600 SERIES !

The device ET-x77-*-P2 / ET-x77-*-PB has a second Ethernet TX (copper) interface in the TX version (1TX not available).

If display types ET-xx7-DVI1-MM or ET-xx7-DVI1-SM (optical fiber versions) are used, terminal X16 remains unused.

In the case of an optical fiber connection the following cable is recommended:

Multi-mode optical fiber cable:

50 µm core cross section and 125 µm external cross section

Single mode optical fiber cable:

9 µm core cross section and 125 µm external cross section

When using the fibre optic interfaces of MANTA devices, they must be connected and safely operated with other devices that comply with the limit values of Class 1 according to IEC 60825-1 or are classified as inherently safe optical radiation "op is" according to IEC 60079-28.

- ** The USBi2 connection (X25) is **NOT** available for devices with touch screen and may **NOT** be connected.

The unused wires of X16 at version 2TX must be isolated according to applicable regulations. This may be by means of double isolation and mechanical fixing by shrink sleeving or vulcanisation. The shrink sleeving or the vulcanisation must be suitable for at least 500 V and be within the temperature parameters of the device. The shrink sleeving / vulcanisation must **NOT** be light blue. When the data cables are shortened, this must also be kept in mind.

14 General Information

14.1 Touch driver

NOTICE

The UPDD touch driver is copyrighted licensed software supplied strictly for use with original R. STAHL HMI Systems GmbH touch systems and under no circumstances should this driver be downloaded or used on any other equipment !

14.2 ET-4x7 (Panel PC) and ET-5x7 (Thin Client)

14.2.1 Up to Windows 7 operating systems

14.2.1.1 Licensing issues

The HMI devices SERIES 400 and 500 which are pre-installed with a Windows operating system are equipped with a license sticker.

The license sticker is affixed on the back of the HMI device, next to the type plate.

Please note that according to the license issued for Windows the application of this system as an Office PC is not permitted.

DOCUMENTATION

Please also note the information on the licensing stipulations for Windows operating systems contained in the "TechNote Windows Operating Systems" file located on the CD / DVD / USB stick, which is part of the delivery.

14.2.1.2 Note on Windows Embedded operating systems

When using the Windows Embedded operating systems (XP or Windows Standard 2009 / 7) on the Panel PC devices SERIES 400, the C:\ system drive can be protected from unauthorised writing (EWF).

NOTICE

This is **NOT** the case with other Windows operating systems !

ATTENTION

R. STAHL HMI Systems GmbH recommends you leave the write protection filter on at all times !

DOCUMENTATION

For further information regarding this Write Protection (EWF), please refer to the OpenHMI_help_en.chm help file in the "STAHL" folder on the device or on the CD / DVD / USB stick that is included in the delivery.

14.2.2 Windows® 10 IoT Enterprise 2019 / 2021 LTSC operating system

The operating system is based on Windows 10 for PC platforms with 64 bit x86 processors. For the LTSC (Long Term Servicing Channel) versions, Microsoft guarantees 10 years of security updates and new builds with feature updates only every 2-3 years, with these being optional. The LTSC versions are ideal for industrial applications and feature additional security components such as write filters (UWF) and HORM * (start of a system snapshot from the RAM plus write protection).

NOTICE

* The HORM function is currently not supported in 2021 LTSC !

From 2016 LTSB onwards, Microsoft has tied its licensing model to the processor performance:
 ENTRY for AMD® GX and ATOM™
 VALUE for Intel® Core i5™
 HIGH for Intel® Core i7™

The Panel PC SERIES 400 HMI devices with Windows 10 IoT Enterprise 2019 / 2021 LTSC operating systems have the license provided as part of the image, with the corresponding label affixed to the back of the device. When delivered, the devices have already been registered and activated.

The EOL (End of Life) date for Windows 10 IoT Enterprise 2019 LTSC for support and updates has been set by Microsoft to 09.01.2029 and for 2021 LTSC to 13.01.2032.

14.2.2.1 Recovery

 NOTICE	If a Panel PC is reset to the factory state (recovered) it will remain registered but will have to be reactivated ! This requires an active internet connection to a Microsoft server !
---	--

14.2.2.2 Company-specific Windows installations

 NOTICE	The Windows 10 IoT license key is tied to STAHL images ! The installation of own Windows 10 IoT operating systems requires a separate license key ! All necessary drivers are provided by R.STAHL HMI Systems GmbH. Please contact our Support department.
---	---

14.2.3 Initial start-up ET-4x7 (Panel PC)

When the device is started for the first time, the Windows installation assistant starts where users have to select certain settings.
Please follow the instructions of the installation assistant.

14.2.4 Recovery Stick

 NOTICE	To restore your Panel PC device to its original state you will need a Recovery Stick, which is part of the delivery. This recovery stick (USB-drive) contains the factory image, with which the system can be restored to delivery status within a very short time. Please note that you can restore the HMI devices to their original state only with the aid of the Recovery Stick
	As an option, the recovery stick can also contain a backup software, with which you can back up your own device configuration.
	The optionally available intrinsically safe recovery stick (USBi-drive) can not be used at the interfaces of the ET-xx7 devices !

14.2.5 Back-up

 NOTICE	Please note that it is the sole responsibility of the operator to generate a back-up of the HMI devices and their overall function. We strongly recommend such a back-up to be stored on an external storage medium or on the company network.
---	---

14.2.6 Switching off / closing down

 NOTICE	The Microsoft Windows operating system stores key data in the main memory, regardless of the application, and has to store this data on the hard disk before the HMI device is switched off.
--	--

 ATTENTION	It is therefore important for the safe and correct operation that the HMI device is closed down properly (see illustration below) and NOT simply switched off. Otherwise the existing image of the device may be damaged, rendering the HMI device non-functioning.
---	--

14.2.7 Data loss

 NOTICE	In the case of applications that require constant writing into memory, R. STAHL HMI systems recommends you use external storage media (USB sticks, network servers) for these write processes.
--	--

 ATTENTION	Try and avoid cyclical writes (log files, databases, etc.) to the SSD ! The endurance of an SSD depends on the number of write cycles (TBW / terabytes written). Writing to the SSD with a simultaneous drop in voltage is most likely going to result in data loss !
---	---

14.3 Teaming function

 NOTICE	For SERIES 500 only (for SERIES 400 only after additional installation of the "Ethernet Chipset Diagnostic Utility Tool")
--	---

Teaming function			
Processor	Interface		
	2TX	SX and TX	LX and TX
ATOM 3845	Yes	No	No
AMD	Yes	No	No
ATOM 3940	Yes	Yes	Yes

- Providing redundancy due to automatic switch to a different network adapter.
- Using the Ethernet adapters in the team as standby adapters, realising redundancy, making the system more fail-safe.
- Bundling the speed of the Ethernet adapters in order to increase performance.

 DOCUMENTATION	For a description of the function and its settings refer to the Remote HMI V6 software manual (industrial-grade Thin Client firmware).
---	--

15 Maintenance, overhaul

Because the transmission of the devices remains reliable and stable over long periods of time, regular adjustments are not required.

Keep the units clean so that the enclosure locks and screws remain accessible. Maintenance may be required for the enclosure seal.

System maintenance should focus on the following:

- a. Seal wear
- b. Display damage
- c. All screws are tightened fast
- d. All cables and lines are properly connected and undamaged

 CAUTION	<p>If the device in its factory state is damaged or altered in any way, decommission it immediately and contact the R. STAHL HMI Systems GmbH !</p> <p>If small glass beads (filling material) escape the device, immediately decommission the device !</p>
--	---

15.1 Damaged sealing

 NOTICE	<p>If a defective seal is found on a device that has been returned to the manufacturer, an agreement is made with the customer as to whether it should be repaired (replaced). If this exchange is not necessary, the option "No hazloc approved panel mount" is marked on the device by the manufacturer.</p> <p>The device is only approved for installation inside an Ex e or Ex tb enclosure if no "No hazloc approved panel mount" option is indicated on the device ! If the "No hazloc approved panel mount" option is indicated on the device, certification according to NEC / CE-Code is no longer possible or becomes void !</p>
---	---

16 Troubleshooting

 NOTICE	<p>Devices operated in hazardous areas must not be modified. Repairs may only be carried out by qualified, authorized staff specially trained for this purpose.</p> <p>Repairs may only be carried out by specially trained staff who are familiar with all basic conditions of the applicable user regulations and – if requested – have been authorized by the manufacturer.</p>
---	--

16.1 Repairs / hazardous substances

An error description must be enclosed with any units returned to R. STAHL HMI Systems GmbH for repairs.

Remove all material residues. Please pay particular attention to the seal grooves and slits where material residues may be lodged. We have to ask you not to return a unit if you are unable to completely remove any hazardous substances. We shall bill you for any costs arising from insufficiently cleaned units, such as disposal or damage to persons (chemical burns, etc.).

17 Disposal / Restricted substances

Disposal of old electric and electronic devices, packaging and used parts is subject to regulations valid in whichever country the device has been installed.

For countries under the jurisdiction of the EU the corresponding WEEE directive applies.

The devices are classified according to the table below:

Directive	WEEE II directive 2012/19/EU
Valid	from 2018-08-15
Category	SG2 screens, monitors, devices with monitors >100 cm ²

R. STAHL HMI Systems GmbH meets the requirements of directive 2012/19/EU (WEEE) and is registered under the number DE 15180083.

We shall take back our devices according to our General Terms and Conditions.

17.1 Declaration of substances and restricted substances

The present declaration is based on the procedure described in the international standard and directives as listed in the table below:

- IEC 62474 : 2018 (DIN EN IEC 62474 : 2019-09)
- (EG) Nr. 1907/2006 (REACH)
- Directive 2011/65/EU (RoHS)
- Resolution MEPC.269(68) "International Maritime Organization" (IMO); particularly "2015 Guidelines for the Development of the Inventory of the Hazardous Materials" (IHM)

17.1.1 Declarable substance groups

ECHA Legal Entity UUID of the R. STAHL HMI Systems GmbH:
ECHA-a4dd94d5-bcd2-405d-8fdd-010a535d7e87

SCIP number: c335aec6-42c1-4204-8edf-b5b8d26ee81e

Component	Designation	Mass (g)	Declarable Substance Groups and Substances (IEC 62474 database)	CAS Nr.	Mass %	Exemption (acc. to directive)
BR2032	Lithium coin cell	2.6	Ethylenglycoldimethyl-ether (1.2-Dimethoxyethan / EGDME)	110-71-4	3.6104	-
BR2330	Lithium coin cell	3.2	Ethylenglycoldimethyl-ether (1.2-Dimethoxyethan / EGDME)	110-71-4	3.8100	-

17.1.2 RoHS directive 2011/65/EC

The devices meet the requirements of RoHS Directive 2011/65/EU.

17.1.3 IMO Resolution MEPC.269(68)

The devices meet the requirements of the MEPC.269(68) Resolution of the "International Maritime Organization" (IMO), in particular the "2015 Guidelines for the Development of the Inventory of the Hazardous Materials" (IHM).

18 Defective pixels

As a result of the manufacturing process (production tolerances and errors) for the displays they may be delivered with defective pixels. Provided they are within the range of the specification below these potential defective pixels are not a display or HMI error or defect.

18.1 Terminology

Defective pixels Pixels or sub-pixels that do not perform as expected and are either always on or always off

Pixel Image point on the display consisting of 3 sub-pixels in the basic colours red, green and blue



Dot Sub-pixel in the basic colour red, green or blue



Bright Sub-pixel (dot) to which light is passing through, creating a bright dot that is on

Dark Sub-pixel (dot) to which no light is passing through, creating a dark dot that is off

adjacent dots dots positioned next to one another, horizontally, vertically or diagonally, bright or dark (e.g. the following pattern and sub-pixels)

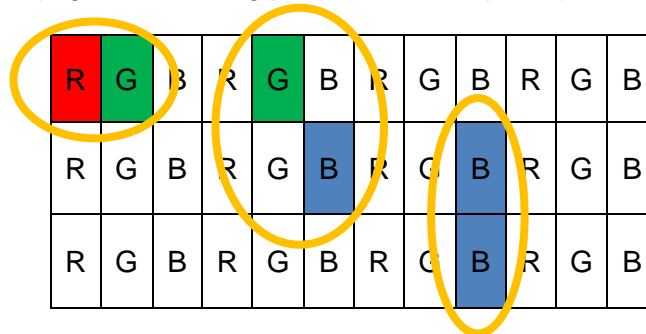

Distance between Dots Definition of distance between two defective dots horizontal, vertical or diagonal, bright or dark (e.g. the following pattern and sub-pixels)

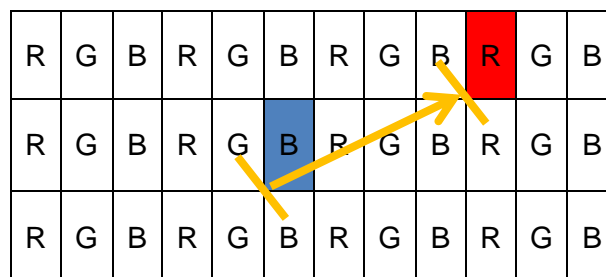

18.2 Display specification ET-x77

Type of defect / description	max. number of permitted defects
	24" display
Linear defect (horizontal, vertical, diagonal)	not permitted
Defective pixels	
bright dots	≤ 2
dark dots	≤ 5
total number of dots	≤ 5
adjacent dots	
2 bright dots	≤ 1 pair
more than 3 bright dots	not permitted
2 dark dots	≤ 2 pairs
more than 3 dark dots	not permitted
Distance between the dots	
between 2 bright dots	≥ 15 mm
between 2 dark dots	≥ 15 mm
between 1 bright and 1 dark dot	≥ 15 mm
ND filter for mura effects, bright and dark dots	view with 8% filter

19 Optical acceptance of surfaces

This section covers the acceptance criteria applicable to the minimum requirements for surfaces of devices and components.

The values for imperfection types listed under "tolerance limits" do not constitute a defect or an imperfection of the device or component and must therefore be tolerated.

19.1 Optical acceptance glass

Imperfection type	Criterion	Tolerance limits
Total imperfections	Number	Max. 3
Cleanness of glass surface	Clearly visible dirt	not permitted
Edge crack / incipient crack	visible	not permitted
Scratches	Width	up to 0.16 mm
	Length	up to 40 mm
	Cumulative length of all scratches	max. 40 mm
	Long side of glass < 300 mm, distance > 70 mm	
	Number	2
	Long side of glass 300 - 600 mm, distance > 70 mm	
	Number	3
Hairline scratches / scraper damage	Width	max. 0.05 mm
	Length	max. 40 mm
Large point defects	Size	max. 0.4 mm ²
	Number	2
Small point defects	Size	max. 0.16 - 0.4 mm ²
	Number	5
Permitted point defects	Size	< 0.16 mm ² , provided there is no cluster ***
Interference points	∅ < 0.2 mm	permitted
	0.2 mm < ∅ ≤ 0.6 mm	permitted provided there is no cluster ***
	0.6 mm < ∅ ≤ 1.3 mm	5
	1.3 mm < ∅ ≤ 2.0 mm	2
	∅ > 2.0 mm	not permitted
Inhomogeneity *	minor colour variations	permitted
White haze **	only visible in reflection	permitted
	not visible when device is in operating position.	permitted

 NOTICE	* in the case of coated float glass, inhomogeneity in the form of minor colour variations can occur and cannot be prevented by any technical means
	** large, cloudy blemish, can be more pronounced towards the centre of the glass, but can also affect larger parts of the glass.
	*** a cluster is an accumulation of more than 7 disregarded, permitted imperfections that occur within an inspected area of a diameter of 40 mm.

19.2 Optical acceptance printing

Description	Tolerance limits
Labelling	Clearly legible, minimum stroke weight 0.3 mm
Characters	clearly legible
Lines and symbols	Gaps not permitted
Ink coverage	sufficient if underlying layers and structures not visible
Acutance	+/- 0.15 mm
Edge blurring	+/- 0.15 mm
Print overlap	possible colour variations in the overlap area are permitted
Variations of stroke weight	10 %
Within a shaping print	"Fine" as specified in DIN ISO 2768-1 General tolerance class
Between shaping prints	< 400 mm +/- 0.3 mm ≥ 400 mm +/- 0.5 mm

Imperfection type	Criterion	Tolerance limits
Dirt and dust particle inclusions, stains, fluff,	Size	max. 0.16 mm ²
	Size for weak colour contrast	max. 0.25 mm ²
	Number / 100 cm ²	1
	Minimum distance	80 mm
	Lower limit	0.063 mm ²





19.3 Optical acceptance, other surfaces

Definitions

Scratch	straight or curved / wavy surface damage
Dents / dings	plastic deformation inwards or outwards
Scuff mark without dent	"punch mark"-type depression

Surface categories

If not specified otherwise in the drawing, the following applies:

A surface	Surface is frequently viewed, typically the front plate. Surface is in customer's field of vision	
	Colour code	
B surface	Surface is occasionally viewed, typically the sides of the device	
	Colour code	
C surface	Surface is rarely viewed, typically the back or bottom of device	
	Colour code	
D surface	Surface is never viewed, typically the inside of the device	
	Colour code	

Accessories such as stand, wall bracket etc. are termed C surfaces

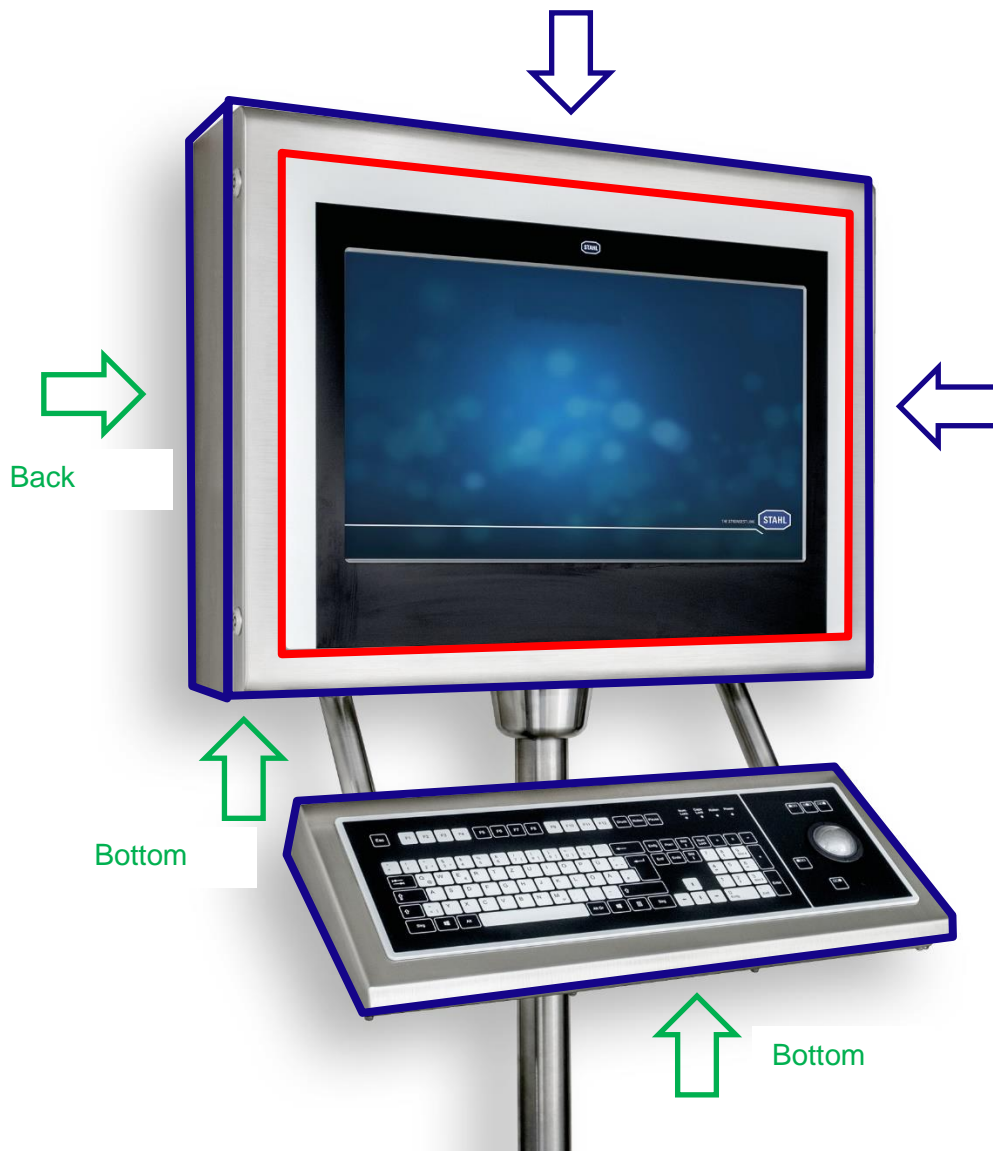

Imperfection type	A surface	B surface	C surface	D surface
Scratches	max. 1 per side	max. 2 per side	1x up to 100 mm with the grain	permitted
	0.05 – 0.1 mm wide and max. 10 mm long	0.05 – 0.1 mm wide and max. 10 mm long		
	or	or	or 1x up to 30 mm against the grain	
	0.01 – 0.05 mm wide and max. 40 mm long	0.01 – 0.05 mm wide and max. 40 mm long		
	only with the grain	only with the grain		
Gouges, depressions (punch-mark-type depression)	not permitted	not permitted	max. 2 per side	permitted
			max. 0.3 mm wide	
			max. 3 mm long	
Dents / cavities	not permitted	not permitted	not permitted	not permitted
welding flaws	not permitted	not permitted	not permitted	not permitted
Chatter marks	not permitted	not permitted	not permitted	not permitted
Material flaws	not permitted	not permitted	not permitted	not permitted
Orange peel: surface not homogeneous	not permitted	not permitted	not permitted	permitted

<p>Alle Rechte vorbehalten Diese Zeichnung darf ohne unsere ausdrückliche Zustimmung weder vervielfältigt, noch Dritten zugänglich gemacht werden. Außerdem darf sie durch den Empfänger oder durch Dritte nicht in anderer Art und Weise missbräuchlich verwendet werden. Stand der Technik - Technische bzw. konstruktive Änderungen vorbehalten.</p>																																							
<h2 style="text-align: center;"><u>Security Advices</u></h2>																																							
<h2 style="text-align: center;"><u>Calculation of cable length</u></h2>																																							

Security Advices

1. No revision to drawing prior to certification body.
2. The Associated Apparatus must be approved by a NRTL.
3. Manufacturer's installation drawing must be followed when installing associated apparatus.
4. Interconnection of equipment apparatus type of protection „I.S.“ with associated apparatus is allowed when the following is true:
 - I.S. Equipment Associated Apparatus
 - $V_{max} > U_0$
 - $I_{max} > I_0$
 - $P_i > P_0$
 - $C_i + C_{cable} < C_0$
 - $L_i + L_{cable} < L_0$

WARNING:

- Substitution of components may impair Safety.
- To prevent ignition of flammable or combustible atmospheres disconnect power and wait a minimum of 7min. before servicing.

The ET-xx7 operator interfaces and connected devices must be integrated in the same system of potential equalization.
As an alternative to this, only devices that are isolated from earth potential may be connected.

All circuits must be wired as specified in the Canadian Electric Code for installation within Canada.

Calculation of cable length

- 1.) Determination of maximum possible capacitance of cable:
 - $C_{max} = C_0 - C_i$ (associated Apparatus)
 Determination of maximum possible inductance of cable:
 - $L_{max} = L_0 - L_i$ (associated Apparatus)
- 2.) Determination of maximum possible cable length by capacitance and inductance of cable:
 - length $C = C_{max}$
 - Cable (*1)
 - length $L = L_{max}$
 - Lcable (*1)
- 3.) Determination of maximum length of cable:
 - length C or length L, whatever is less.
 - (*1) when cable parameters are unknown, the following values may be used:
 - Cable = 60 pF/ft. (200 pF/m)
 - Lcable = 0.2 µH/ft. (0.66 µH/m)

		STAHL HMI Systems GmbH D-57474 Lennep Tel. +49 (0)274 5800200 Fax. +49 (0)274 5800201 www.stahl-hmi.de	
UNTER ANSCHESSUNG BEFESTIGEN! DIMENSIONIEREN SIE IN MILLIMETERN (KOPFEN)! VERBODEN SIND VERBUNDENHEITEN BEI DER ANSCHLIEßUNG! (Nicht angeschlossen)	DATEI: 23.07.2014 ANZEIGEN: JA CHECKBOXEN: JA		
DRAWING NO. TITLE 11100024 Rev.001 EEX Control Drawing			

21 Mounting inside enclosure with ET-xx7 mounting-set

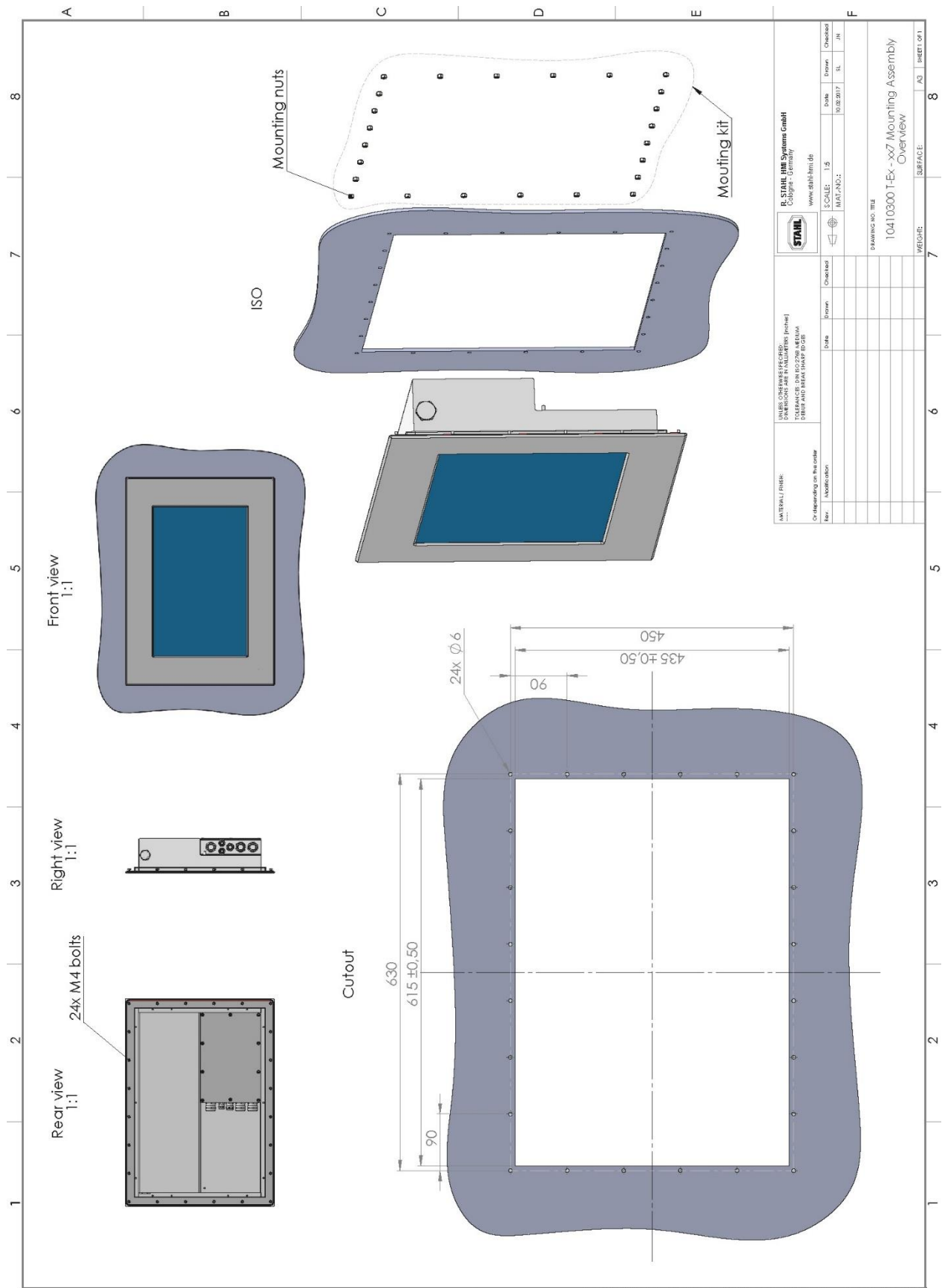

Alle Rechte vorbehalten | Diese Zeichnung darf ohne unsere ausdrückliche Zustimmung weder vervielfältigt, noch Dritten zugänglich gemacht werden. Außerdem darf sie durch den Empfänger oder durch Dritte nicht in anderer Art und Weise mitbewerben oder verändert werden. Stand der Technik - Technische Änderungen vorbehalten.

All rights reserved. Without our express consent this image may not be copied, made available to third parties or used in any other way not intended by the owner. State of the art - subject to technical or design alterations.



DEKRA EXAM GmbH

Fachstelle für
Sicherheit elektrischer
Betriebsmittel - BVS

Dinnendahlstraße 9
44809 Bochum

Telefon +49.234.3696-300
Telefax +49.234.3696-301

Änderungsinformation - *Revision Report*

Prüfprotokoll - *Test and Assessment Report* BVS PP 11.2174 EG

Die mit folgender Dokumentation festgelegte Änderung hat keinen Einfluss auf die in o.g. Prüfprotokoll getroffenen Festlegungen für das Zertifikat.

Das Terminal Typ T-Ex kann in den passenden Ausschnitt eines Ex e, Ex p oder Ex tb zertifizierten Gehäuses eingebaut werden.

Der Einbau und der dazu zu verwendende Einbausatz inklusive der Dichtung sind in den Unterlagen festgelegt und wurden praktisch geprüft:

- 1) Wärme- / Kältebeständigkeit (BVSPS28426)
- 2) Druckprüfung (20 mbar) (BVSPS28577)
- 3) IP66 Prüfung (BVSPS28598)

The modification as defined in the following documentation does not influence the details of the aforementioned test and assessment report with reference to the certificate.

The terminal type T-Ex can be mounted in a suitable cutout of an Ex e, Ex p or Ex tb approved enclosure.

The mounting process as well as the mounting kit including the sealing are fixed in the documentation and were tested

- 4) *Thermal endurance to heat / cold (BVSPS28426)*
- 5) *Pressure test (20 mbar) (BVSPS28577)*
- 6) *IP66 test (BVSPS28598)*

Dokumentation - Descriptive Documents

Beschreibung (8 Bl.) - *Description (8 pages)*, unterschrieben am - *signed* 10.02.2017

Zeichnung Nr. - <i>Drawing no.</i>	vom - <i>dated</i>	unterschrieben am – <i>signed</i>
10410300 T-Ex-xx7	10.02.17	10.02.17
10410310 T-Ex-xx7	10.02.17	10.02.17

44809 Bochum, den 02.08.2017
BVS-Pz/Mu A 20161137

DEKRA EXAM GmbH
Fachstelle für Sicherheit elektrischer Betriebsmittel - BVS

Die Sachverständige - *The Testing Officer*

Seite 1 von 1 zur Änderungsinformation zu - *Page 1 of 1 of Revision Report to BVS PP 11.2174 EG*

Diese Änderungsinformation darf nur vollständig und unverändert vervielfältigt werden.

This revision report may only be reproduced in its entirety and without change.

DEKRA EXAM GmbH Dinnendahlstraße 9 44809 Bochum Telefon-Phone +49.234.3696-300 Telefax-Fax +49.234.3696-301 E-mail bvs-exam@dekra.com

22 Installation Instructions Requirements China

安装使用要求

Installation Instructions Requirements



认证编号

CN2021C2309-000646-2

Certification No.

本产品经认证符合 CNCA-C23-01: 2019 《强制性产品认证实施规则 防爆电气》的要求。

The product(s) is verified and certified according to CNCA-C23-01: 2019 China Compulsory Certification Implementation Rule on Explosion Protected Electrical Product.

#	产品名称 Product 型号 Type	防爆标志 Ex Marking
1	防爆人机界面 ET - ab7-c-d-e-f-g-h-i-j-k-l-m, ET - 6a7-b-c-d-e-f-g-h-i	Ex eb q [ia op is Ga] IIC T4 Gb, Ex tb [ia op is Da] IIIC T110°C Db

系列标准 Series standards	GB/T3836.1-2021, GB/T3836.3-2021, GB/T3836.4-2021, GB/T3836.7-2017, GB/T3836.31-2021
安全使用条件 Specific conditions of safety use:	<ul style="list-style-type: none"> - 人机界面和指点设备之间的本安电路必须等电位连接。 - 在可能产生传播型刷型放电的区域，不得使用指点设备。 - 本产品认证不包括对光辐射“op is”标准的评价和试验。 - 本安电路接地，安装时应符合GB/T3836.15相关要求。 - Along the intrinsically safe circuits between Display Unit and Pointing Device potential equalisation must exist. - The Pointing Device shall not be used in areas where charging mechanism creating propagating brush discharges have to be regarded. - The evaluation and test of the optical radiation "op is" standard are not included in the scope of this product certification. - The intrinsically safe circuit is grounded, and the installation should meet the relevant requirements of GB/T3836.15.

R. STAHL HMI Systems GmbH

产品上的符合性标志:

Compliance marks on product:



中国强制性认证

China Compulsory Certification

CCC: 2021312309000500

德国制造 Made in Germany

Doc No.:

Approved:

Date : 2023.03.20

23 Declarations of conformity

23.1 EC

EU-Konformitätserklärung
EU Declaration of Conformity
Déclaration de Conformité UE



R. STAHL HMI Systems GmbH • Adolf-Grimme-Allee 8 • 50829 Köln, Germany

erklärt in alleiniger Verantwortung, *declares in its sole responsibility, déclare sous sa seule responsabilité,*

dass das Produkt:

that the product:

que le produit:

Bedien- und Beobachtungsgeräte

Operating and Monitoring Devices

Consoles de commande et de visualisation

Typ(en), *type(s), type(s):*

Display Unit T-EX-##*-R2 or ET-##7*

Keyboard Trackb. Unit T-EX*-KB-TB* or KBDi-USB-TB50*

Keyboard Mouse Unit T-EX*-KB-M* or KBDi-USB-M*

Keyboard Pad Unit T-EX*-KB-P* or KBDi-USB-P*

Keyboard Joystick Unit T-EX*-KB-J* or KBDi-USB-J*

Transmission Unit T-EX-KVM*-* or KVM*-*

*=any alphanumeric or symbolic character, without relevance for explosion protection

#=one numeric character, without relevance for explosion protection

mit den Anforderungen der folgenden Richtlinien und Normen übereinstimmt.

is in conformity with the requirements of the following directives and standards.

est conforme aux exigences des directives et des normes suivantes.

Richtlinie(n) / Directive(s) / Directive(s)	Norm(en) / Standard(s) / Norme(s)
2014/34/EU 2014/34/EU 2014/34/UE	ATEX-Richtlinie ATEX Directive Directive ATEX
	EN 60079-0:2009 EN 60079-5:2007 EN 60079-7:2007 EN 60079-11:2007 EN 60079-26:2007 EN 60079-28:2004 EN 60079-31:2009 EN 61241-11:2006
	Das Produkt entspricht Anforderungen aus: <i>Product corresponds to requirements from:</i> <i>Produit correspond aux exigences:</i> EN 60079-0:2012/A11:2013 EN IEC 60079-0:2018 EN 60079-5:2015 EN 60079-7:2015 EN IEC 60079-7:2015 + A1:2018 EN 60079-11:2012 EN 60079-26:2015 EN 60079-28:2015 EN 60079-31:2014

Kennzeichnung, *marking, marquage:*

Display Unit T-EX-##*-R2 or ET-##7*:

II 2(1) G Ex eb q [ia op is Ga] IIC T4 Gb

II 2(1) D Ex tb IIIC [ja op is Da] T110°C Db

Keyboard Trackb. Unit T-EX*-KB-TB* or KBDi-USB-TB50*, Keyboard Mouse Unit T-EX*-KB-M* or KBDi-USB-M*, Keyboard Pad Unit T-EX*-KB-P* or KBDi-USB-P*, Keyboard Joystick Unit T-EX*-KB-J* or KBDi-USB-J*:

II 2 G Ex ia IIC T4 Gb

II 2 D Ex ia IIIB T110°C Db

Transmission Unit T-EX-KVM*-* or KVM*-*:

II (1) G [Ex op is Ga] IIC

II (1) D [Ex op is Da] IIIB



CE 0158

EU-Baumusterprüfbescheinigung:

EU Type Examination Certificate:

Attestation d'examen UE de type:

BVS 11 ATEX E 102 X

(DEKRA EXAM GmbH,

Dinnendahlstraße 9, 44809 Bochum, Germany, NB0158)

Produktnormen nach Niederspannungsrichtlinie:
Product standards according to Low Voltage Directive:
Normes des produit pour la Directive Basse Tension:

EN 61010-1:2001 + Corrigendum / Errata

DIN EN 62368-1:2016, IEC 62368-1:2014 (Second Edition)

EU-Konformitätserklärung
EU Declaration of Conformity
Déclaration de Conformité UE



2014/30/EU 2014/30/EU 2014/30/UE	EMV-Richtlinie EMC Directive Directive CEM	EN 61000-6-2:2005 EN 61000-6-4:2007 + A1:2011
2011/65/EU 2011/65/EU 2011/65/UE	RoHS-Richtlinie: RoHS Directive: Directive RoHS:	EN IEC 63000:2018

Für spezifische Merkmale und Bedingungen siehe Betriebsanleitung.
 For specific characteristics and conditions see operating instructions.
 Pour les caractéristiques et conditions spécifiques, voir le mode d'emploi.

Köln, 2020-12-10

i.V.

Jordan Düren

i.V.

A. Jung

Ort und Datum
 Place and date
 Lieu et date

J. Düren
 Technical Director

A. Jung
 Ex Representative

23.2 CCC

23.2.1 English version



CERTIFICATE FOR CHINA COMPULSORY PRODUCT CERTIFICATION

No.: 2021312309000500

Applicant	R. STAHL HMI Systems GmbH
Address	Adolf-Grimme Allee 8, 50829 Koln, Germany
Manufacturer	R. STAHL HMI Systems GmbH
Address	Adolf-Grimme Allee 8, 50829 Koln, Germany
Production Factory	R. STAHL HMI Systems GmbH
Production Address	Adolf-Grimme Allee 8, 50829 Koln, Germany
Product	Display Unit
Model/Type	ET - ab7-c-d-e-f-g-h-i-j-k-l-m, ET - 6a7-b-c-d-e-f-g-h-i
Ex marking	Ex eb q [ia op is Ga] IIC T4 Gb, Ex tb [ia op is Da] IIIC T110°C Db
Reference Standards	GB/T 3836.1-2021, GB/T 3836.3-2021, GB/T 3836.4-2021, GB/T 3836.7-2017, GB/T 3836.31-2021

Certification mode Type Test + Initial Factory Inspection + Post-Certification Surveillance

The product(s) is verified and certified according to CNCA-C23-01: 2019 *China Compulsory Certification Implementation Rule on Explosion Protected Electrical Product* and CNEX-C2301-2019 *Guideline of China Compulsory Certification Implementation Rule on Explosion Protected Electrical Product*.

See Annex for the detailed product information (8 pages)

Initial issue date: 2021-06-09

Issued date: 2023-04-29

Valid to: 2026-06-08

The validity of this certificate is maintained through the regular supervision of the issuing authority during the validity period.

Where any discrepancy arises between the English translation and the original Chinese version, the Chinese version shall prevail.

Director:



Nanyang Explosion Protected Electrical
Apparatus Research Institute Co.,Ltd.



<http://www.ccc-cnex.com>
ccc.china-ex.com

Add: No. 20, North Zhongjing Road, Nanyang, Henan, P. R. China P.C.: 473008
Tel: 0377-63239734 Email: ccc@cn-ex.com

CN 0001902



CERTIFICATE FOR CHINA COMPULSORY PRODUCT CERTIFICATION (Annex)

No.: 2021312309000500

Page 1 of 8

Product information:

1. This certificate covers the following models:
- ET - ab7-c-d-e-f-g-h-i-j-k-l-m, ET - 6a7-b-c-d-e-f-g-h-i

Nomenclature of ET-ab7-c-d-e-f-g-h-i-j-k-l-m:

ET-	a	b	7	-c	-d	-e	-f	-g	-h	-i	-j	-k	-l	-m
-----	---	---	---	----	----	----	----	----	----	----	----	----	----	----

- a: Technology
 - 4: Panel PC
 - 5: Thin Client
- b: Display size
 - 6 = 56 cm / 22" display
 - 7 = 61 cm / 24" display
 - 8 = 24"WU display
- 7: HMI series
 - 7: xx7 HMI series
- c: Ethernet interface
 - SX: Optical fiber Ethernet interface 1000Base-SX (Ex op is), multi-mode
 - LX: Optical fiber Ethernet interface 1000Base-LX (Ex op is), single mode
 - TX: 1x Copper Ethernet interface 10/100Base-TX
 - 2TX: 2x Copper Ethernet interface 10/100Base-TX
- d: Processor type
 - BT: Bay Trail
 - P2: AMD GX
- e: Display type
 - TFT display (standard)
- f: Touch screen
 - 00: No touch
 - T: Touch screen (membrane)
 - TG: Touch screen glass

Issued date: 2023-04-29

Director:



**Nanyang Explosion Protected Electrical
Apparatus Research Institute Co.,Ltd.**



http://www.ccc-cnex.com
ccc.china-ex.com

Add: No. 20, North Zhongjing Road, Nanyang, Henan, P. R. China
Tel: 0377-63239734

P.C.: 473008
Email: ccc@cn-ex.com



CERTIFICATE FOR CHINA COMPULSORY PRODUCT CERTIFICATION
(Annex)

No.: 2021312309000500

Page 2 of 8

- g: RAM size
R3: 4 GB RAM
- h: Solid state drive
64GB: 64 GB Solid State Drive
128GBM: 128 GB Solid State Drive MLC
- i: Audio option
000: Standard installation (no audio)
SND: Audio amplifier (mono amplifier) 3.5 W
- j: Power supply
AC: Power supply 100 ~ 240 V AC, 50 ~ 60 Hz
DC: Power supply 24 V DC
- k: Outdoor option
000: Standard installation
O30: Outdoor installation -30°C (The O30 option is only available for AC devices)
- l: Front design
AL: Aluminium front plate
RM: Rear mount module
VA: Stainless steel 1.4301 front plate
- m: Design
000= Standard design
SIE= Siemens design

Nomenclature of ET-6a7-b-c-d-e-f-g-h-i:

ET-	6	a	7	-b	-c	-d	-e	-f	-g	-h	-i
-----	---	---	---	----	----	----	----	----	----	----	----

- 6: System
6: KVM System
- a: Display size
6 = 56 cm / 22" display
7 = 61 cm / 24" display

Issued date: 2023-04-29

Director:



Nanyang Explosion Protected Electrical Apparatus Research Institute Co.,Ltd.



<http://www.ccc-cnex.com>
ccc.china-ex.com

Add: No. 20, North Zhongjing Road, Nanyang, Henan, P. R. China P.C.: 473008
Tel: 0377-63239734 Email: ccc@cn-ex.com



CERTIFICATE FOR CHINA COMPULSORY PRODUCT CERTIFICATION (Annex)

No.: 2021312309000500

Page 3 of 8

8 = 24"WU display

7: HMI Series

7: xx7 HMI Series

b: Transfer technology

DVI1-CAT: DVI1 KVM, with direct copper connection, Gigabit

DVI1-MM: DVI1 KVM, with direct optical fibre connection (Ex op is), multi-mode

DVI1-SM: DVI1 KVM, with direct optical fibre connection (Ex op is), single mode

DVI2-CAT: DVI2 KVM, with direct copper connection, Gigabit

DVI3-CAT: DVI3 KVM, with direct copper connection, Gigabit

DVI3-MM-FO: DVI3 KVM, with direct optical fibre connection (Ex op is),
multi-mode

DVI3-SM-FO: DVI3 KVM, with direct optical fibre connection (Ex op is),
single mode

c: Display type

TFT: TFT display (standard)

d: Touch screen

00: No touch

T: Touch screen (membrane)

TG: Touch screen glass

e: Audio

000: Standard installation (no audio)

SND: Audio amplifier (mono amplifier) 3.5 W

f: Power supply

AC: Power supply 100 ~ 240V AC, 50 ~ 60 Hz

DC: Power supply 24V DC

g: Outdoor option

000: Standard installation

O30: Outdoor installation -30°C (The O30 option is only available for AC devices)

h: Front design

AL: Aluminium front plate

Issued date: 2023-04-29

Director:



Nanyang Explosion Protected Electrical
Apparatus Research Institute Co.,Ltd.



<http://www.ccc-cnex.com>
ccc.china-ex.com

Add: No. 20, North Zhongjing Road, Nanyang, Henan, P. R. China
Tel: 0377-63239734

P.C.: 473008
Email: ccc@cn-ex.com



CERTIFICATE FOR CHINA COMPULSORY PRODUCT CERTIFICATION
(Annex)

No.: 2021312309000500

Page 4 of 8

RM: Rear end module
VA: stainless steel 1.4301 front plate

i: Design
000= Standard design
SIE= Siemens design

Parameters:

Electrical data:

"PWR" interface parameter for X10 (Ex e):	
U	20~240V AC/DC
I	≤5A
P	≤150W
Maximum r.m.s. a.c. voltage U_m	≤250V
"USB" interface parameter for X13 (Ex e):	
U	5V+10% AC/DC
Maximum r.m.s. a.c. or d.c. voltage U_m	≤250V
"12V" interface parameter for X14 (Ex e):	
U	12V+10% AC/DC
Maximum r.m.s. a.c. or d.c. voltage U_m	≤250V
"CAT7 1" interface parameter for X16 (Ex e):	
U	5V+10% AC/DC
Maximum r.m.s. a.c. or d.c. voltage U_m	≤250V
"SER" interface parameter for X97 (Ex e):	
U	15V+10% AC/DC
Maximum r.m.s. a.c. or d.c. voltage U_m	≤250V

Issued date: 2023-04-29

Director:



Nanyang Explosion Protected Electrical Apparatus Research Institute Co.,Ltd.



<http://www.ccc-cnex.com>
ccc.china-ex.com

Add: No. 20, North Zhongjing Road, Nanyang, Henan, P. R. China P.C.: 473008
Tel: 0377-63239734 Email: ccc@cn-ex.com



CERTIFICATE FOR CHINA COMPULSORY PRODUCT CERTIFICATION
(Annex)

No.: 2021312309000500

Page 5 of 8

"CAM" interface parameter for X101 (Ex e):	
U	5V+10% AC/DC
Maximum r.m.s. a.c. or d.c. voltage U_m	$\leq 250V$
"AUD" interface parameter for X105 (Ex e):	
U	100V+10% AC/DC
Maximum r.m.s. a.c. or d.c. voltage U_m	$\leq 250V$

Connector X11 (Ex ia) Keyboard:			
U_o	5.5VDC	U_i	5.5VDC
I_o	309mA	I_i	3A
P_o	629mW	P_i	2W
C_o	50uF	C_i	negligible
L_o	40uH	L_i	negligible

Connector X12 (Ex ia) Trackball:			
U_o	5.5VDC	U_i	5.5VDC
I_o	309mA	I_i	3A
P_o	629mW	P_i	2W
C_o	50uF	C_i	negligible
L_o	40uH	L_i	negligible

Connector X24 (Ex ia) USB1:			
U_o	5.5VDC	U_i	5.5VDC

Issued date: 2023-04-29

Director:



Nanyang Explosion Protected Electrical Apparatus Research Institute Co.,Ltd.



<http://www.ccc-cnex.com>
ccc.china-ex.com

Add: No. 20, North Zhongjing Road, Nanyang, Henan, P. R. China P.C.: 473008
Tel: 0377-63239734 Email: ccc@cn-ex.com



CERTIFICATE FOR CHINA COMPULSORY PRODUCT CERTIFICATION
(Annex)

No.: 2021312309000500

Page 6 of 8

I _o	309mA	I _i	3A
P _o	629mW	P _i	2W
C _o	50uF	C _i	negligible
L _o	40uH	L _i	negligible

Connector X25 (Ex ia) USB2i:			
U _o	5.5VDC	U _i	5.5VDC
I _o	309mA	I _i	3A
P _o	629mW	P _i	2W
C _o	50uF	C _i	negligible
L _o	40uH	L _i	negligible

Only for ET-6x7*-MM* and type ET-6x7*-SM*:

External inherently safe optical interface:

"FO 1" interface parameter for X18 (Ex op is):

ET-6x7*-MM*	
Wavelength	850 nm
Radiant power	0.22 mW
max. radiant power	35 mW

ET-6x7*-SM*	
Wavelength	1310 nm
Radiant power	0.22 mW

Issued date: 2023-04-29

Director:



Nanyang Explosion Protected Electrical Apparatus Research Institute Co.,Ltd.



http://www.ccc-cnex.com
ccc.china-ex.com

Add: No. 20, North Zhongjing Road, Nanyang, Henan, P. R. China P.C.: 473008
Tel: 0377-63239734 Email: ccc@cn-ex.com



CERTIFICATE FOR CHINA COMPULSORY PRODUCT CERTIFICATION
(Annex)

No.: 2021312309000500

Page 7 of 8

max. radiant power	35 mW
--------------------	-------

Thermal Data: Ta = -30°C ~ +60°C

Temperature class	T4
Max. surface temperature T with thermo fuse limited to 110 °C	

Degrees of protection: IP65

Ex marking: Ex eb q [ia op is Ga] IIC T4 Gb, Ex tb [ia op is Da] IIIC T110°C Db

- Producers should organize production in accordance with the technical documents approved by the certification body.
- 2. Specific conditions of safety use:
 - Along the intrinsically safe circuits between Display Unit and Pointing Device potential equalisation must exist.
 - The Pointing Device shall not be used in areas where charging mechanism creating propagating brush discharges have to be regarded.
 - The evaluation and test of the optical radiation "op is" standard are not included in the scope of this product certification.
 - The intrinsically safe circuit is grounded, and the installation should meet the relevant requirements of GB/T3836.15.
 - See instruction for other information.
- 3. Certificate related report(s):
 - Type test report: CQST2104C044, CQST2104C044/01
 - Factory inspection report: CN2023Q030119

Issued date: 2023-04-29

Director:



Nanyang Explosion Protected Electrical Apparatus Research Institute Co.,Ltd.



<http://www.ccc-cnex.com>
ccc.china-ex.com

Add: No. 20, North Zhongjing Road, Nanyang, Henan, P. R. China P.C.: 473008
Tel: 0377-63239734 Email: ccc@cn-ex.com



CERTIFICATE FOR CHINA COMPULSORY PRODUCT CERTIFICATION (Annex)

No.: 2021312309000500

Page 8 of 8

4. Certificate change information:

- The changing of Model Nomenclature of the product is as first change on April 28, 2022.
- 2nd change on April 29, 2023: Updated the standards for certification.

Issued date: 2023-04-29

Director:



Nanyang Explosion Protected Electrical Apparatus Research Institute Co.,Ltd.



<http://www.ccc-cnex.com>
ccc.china-ex.com

Add: No. 20, North Zhongjing Road, Nanyang, Henan, P. R. China
Tel: 0377-63239734

P.C.: 473008
Email: ccc@cn-ex.com

23.2.2 Chinese version



中国国家强制性产品认证证书

编 号: 2021312309000500

委 托 人	R. STAHL HMI Systems GmbH
地 址	Adolf-Grimme Allee 8, 50829 Koln, Germany
生 产 者	R. STAHL HMI Systems GmbH
地 址	Adolf-Grimme Allee 8, 50829 Koln, Germany
生 产 企 业	R. STAHL HMI Systems GmbH
生 产 地 址	Adolf-Grimme Allee 8, 50829 Koln, Germany
产 品 名 称	防爆人机界面
型 号 规 格	ET - ab7-c-d-e-f-g-h-i-j-k-l-m, ET - 6a7-b-c-d-e-f-g-h-i
防 爆 标 志	Ex eb q [ia op is Ga] IIC T4 Gb, Ex tb [ia op is Da] IIIC T110°C Db
依 据 标 准	GB/T 3836.1-2021, GB/T 3836.3-2021, GB/T 3836.4-2021, GB/T 3836.7-2017, GB/T 3836.31-2021

认 证 模 式 型式试验+初始工厂检查+获证后监督

上述产品符合 CNCA-C23-01: 2019 《强制性产品认证实施规则 防爆电气》
和 CNEX-C2301-2019 《强制性产品认证实施细则 防爆电气》的要求。

产品相关信息见附页 (共 8 页)。

首次发证日期: 2021 年 06 月 09 日

颁发日期: 2023 年 04 月 29 日

有效期至: 2026 年 06 月 08 日

证书有效期内本证书的有效性依据发证机构的定期监督获得保持。

主任:



南阳防爆电气研究所有限公司



网址: www.ccc-cnex.com
ccc.china-ex.com

地址: 中国河南省南阳市仲景北路20号
电话: 0377-63239734

中国认可
产品
PRODUCT
CNAS C208-P
邮政编码: 473008
邮箱: ccc@cn-ex.com

CN 0025798



中国国家强制性产品认证证书 (附页)

编 号: 2021312309000500

第 1 页 共 8 页

产品相关信息:

1、本证书覆盖产品如下:

- ET - ab7-c-d-e-f-g-h-i-j-k-l-m, ET - 6a7-b-c-d-e-f-g-h-i

ET-ab7-c-d-e-f-g-h-i-j-k-l-m 命名规则:

ET-	a	b	7	-c	-d	-e	-f	-g	-h	-i	-j	-k	-l	-m
-----	---	---	---	----	----	----	----	----	----	----	----	----	----	----

- a: 技术
 - 4: 平板电脑
 - 5: 轻薄客户端
- b: 显示屏尺寸
 - 6: 56cm/22"显示屏
 - 7: 61cm/24"显示屏
 - 8: 24"WU 显示屏
- 7: xx7 HMI 系列
 - 7: xx7 HMI 系列
- c: 以太网接口
 - SX: 光纤以太网接口 1000Base-SX (Ex op is), 多模,
 - LX: 光纤以太网接口 1000Base-LX(Ex op is), 单模
 - TX: 1×铜以太网接口 10/100Base-TX
 - 2TX: 2×铜以太网接口 10/100Base-TX
- d: 处理器类型
 - BT: Bay Trail
 - P2: AMD GX
- e: 显示屏类型
 - TFT 显示屏 (标准)

颁发日期: 2023 年 04 月 29 日

主任:



南阳防爆电气研究所有限公司



网址: www.ccc-cnex.com
ccc.china-ex.com

地址: 中国河南省南阳市仲景北路20号
电话: 0377-63239734

邮政编码: 473008
邮箱: ccc@cn-ex.com



中国国家强制性产品认证证书 (附页)

编 号: 2021312309000500

第 2 页 共 8 页

- f: 触摸屏
 - 00: 无触摸屏
 - T: 触摸屏 (薄膜)
 - TG: 玻璃触摸屏
- g: 内存
 - R3: 内存 4GB
- h: 数据存储器
 - 64GB: 64 GB 固态硬盘
 - 128GBM: 128 GB 固态硬盘 MLC
- i: 音频
 - 000: 标准安装 (无音频)
 - SND: 音频放大器 (单声道放大器) 3.5 W
- j: 电源
 - AC: 电源 100 ~ 240V AC, 50 ~ 60 Hz
 - DC: 电源 24V DC
- k: 户外选装件
 - 000: 标准安装
 - O30: 户外安装 -30°C (O30 选装件仅用于交流设备)
- l: 正面结构
 - AL: 铝制前面板
 - RM: 背部安装版本
 - VA: 1.4301 不锈钢前板
- m: 设计
 - 000: 标准设计
 - SIE: Siemens 设计

ET-6a7-b-c-d-e-f-g-h-i 命名规则:

ET-	6	a	7	-b	-c	-d	-e	-f	-g	-h	-i
-----	---	---	---	----	----	----	----	----	----	----	----

颁发日期: 2023 年 04 月 29 日

主任:



南阳防爆电气研究所有限公司



网址: www.ccc-cnex.com
ccc.china-ex.com

地址: 中国河南省南阳市仲景北路20号
电话: 0377-63239734

邮政编码: 473008
邮箱: ccc@cn-ex.com



中国国家强制性产品认证证书 (附页)

编 号: 2021312309000500

第 3 页 共 8 页

- 6: 系统
6: KVM 系统
- a: 显示屏尺寸
6: 56cm/22"显示屏
7: 61cm/24"显示屏
8: 24"WU 显示屏
- 7: HMI 系列
7: xx7 HMI 系列
- b: 传输技术
DVI1-CAT: DVI1 KVM, 直接带铜接口, 千兆位
DVI1-MM: DVI1 KVM, 直接带光纤接口 (Ex op is), 多模
DVI1-SM: DVI1 KVM, 直接带光纤接口 (Ex op is), 单模
DVI2-CAT: DVI2 KVM, 直接带铜接口, 千兆位
DVI3-CAT: DVI3 KVM, 直接带铜接口, 千兆位
DVI3-MM-FO: DVI3 KVM, 直接带光纤接口 (Ex op is), 多模
DVI3-SM-FO: DVI3 KVM, 直接带光纤接口 (Ex op is), 单模
- c: 显示屏类型
TFT: TFT 显示屏 (标准)
- d: 触摸屏
00: 无触摸屏
T: 触摸屏 (薄膜)
TG: 玻璃触摸屏
- e: 音频
000: 标准安装 (无音频)
SND: 音频放大器 (单声道放大器) 3.5 W
- f: 电源
AC: 电源 100 ~ 240V AC, 50 ~ 60 Hz
DC: 电源 24V DC
- g: 户外选装件

颁发日期: 2023 年 04 月 29 日

主任:



南阳防爆电气研究所有限公司



网址: www.ccc-cnex.com
ccc.china-ex.com

地址: 中国河南省南阳市仲景北路20号
电话: 0377-63239734

邮政编码: 473008
邮箱: ccc@cn-ex.com



中国国家强制性产品认证证书 (附页)

编 号: 2021312309000500

第 4 页 共 8 页

000: 标准安装
O30: 户外安装 -30°C (O30 选装件仅用于交流设备)

h: 正面结构
AL: 铝制前面板
RM: 背部安装版本
VA: 不锈钢 1.4301 前板

i: 设计
000: 标准设计
SIE: Siemens 设计

参数:

电气参数:

X10 (Ex e) 的“PWR”接口参数:	
U	20~240V AC/DC
I	≤5A
P	≤150W
最大 r.m.s a.c 电压 U_m	≤250V
X13 (Ex e) 的“USB”接口参数:	
U	5V+10% AC/DC
最大 r.m.s. a.c.或 d.c.电压 U_m	≤250V
X14 (Ex e) 的“12V”接口参数:	
U	12V+10% AC/DC
最大 r.m.s. a.c.或 d.c.电压 U_m	≤250V
X16 (Ex e) 的“CAT7 1”接口参数:	
U	5V+10% AC/DC

颁发日期: 2023 年 04 月 29 日

主任:



南阳防爆电气研究所有限公司



网址: www.ccc-cnex.com
ccc.china-ex.com

地址: 中国河南省南阳市仲景北路20号
电话: 0377-63239734

邮政编码: 473008
邮箱: ccc@cn-ex.com



中国国家强制性产品认证证书 (附页)

编 号: 2021312309000500

第 5 页 共 8 页

最大 r.m.s. a.c.或 d.c.电压 U_m	$\leq 250V$
X97 (Ex e) 的“SER”接口参数:	
U	15V+10% AC/DC
最大 r.m.s. a.c.或 d.c.电压 U_m	$\leq 250V$
X101 (Ex e) 的“CAM”接口参数:	
U	5V+10% AC/DC
最大 r.m.s. a.c.或 d.c.电压 U_m	$\leq 250V$
X105 (Ex e) 的“AUD”接口参数:	
U	100V+10% AC/DC
最大 r.m.s. a.c.或 d.c.电压 U_m	$\leq 250V$

连接器 X11 (Ex ia) 键盘:			
U_o	5.5VDC	U_i	5.5VDC
I_o	309mA	I_i	3A
P_o	629mW	P_i	2W
C_o	50uF	C_i	可忽略
L_o	40uH	L_i	可忽略

连接器 X12 (Ex ia) 轨迹球:			
U_o	5.5VDC	U_i	5.5VDC
I_o	309mA	I_i	3A
P_o	629mW	P_i	2W
C_o	50uF	C_i	可忽略

颁发日期: 2023 年 04 月 29 日

主任:



南阳防爆电气研究所有限公司



网址: www.ccc-cnex.com
ccc.china-ex.com

地址: 中国河南省南阳市仲景北路20号
电话: 0377-63239734

邮政编码: 473008
邮箱: ccc@cn-ex.com



中国国家强制性产品认证证书 (附页)

编 号：2021312309000500

第 6 页 共 8 页

L _o	40uH	L _i	可忽略
----------------	------	----------------	-----

连接器 X24 (Ex ia) USB1i:			
U _o	5.5VDC	U _i	5.5VDC
I _o	309mA	I _i	3A
P _o	629mW	P _i	2W
C _o	50uF	C _i	可忽略
L _o	40uH	L _i	可忽略

连接器 X25 (Ex ia) USB2i:			
U _o	5.5VDC	U _i	5.5VDC
I _o	309mA	I _i	3A
P _o	629mW	P _i	2W
C _o	50uF	C _i	可忽略
L _o	40uH	L _i	可忽略

仅用于 ET-6x7*-MM*和 ET-6x7*-SM*型号:

外部本安光纤接口:

X18 的 "FO 1" 接口参数 (Ex op is) :

ET-6x7*-MM*	
波长	850 nm
辐射功率	0.22 mW
最大辐射功率	35 mW

颁发日期: 2023 年 04 月 29 日

主任:



南阳防爆电气研究所有限公司



网址: www.ccc-cnex.com
ccc.china-ex.com

地址: 中国河南省南阳市仲景北路20号
电话: 0377-63239734

邮政编码: 473008
邮箱: ccc@cn-ex.com



中国国家强制性产品认证证书 (附页)

编 号: 2021312309000500

第 7 页 共 8 页

ET-6x7*-SM*	
波长	1310 nm
辐射功率	0.22 mW
最大辐射功率	35 mW

热参数: $T_a = -30^{\circ}\text{C} \sim +60^{\circ}\text{C}$

温度组别	T4
带有熔断器的最高表面温度 T 限制在 110°C	

外壳防护等级: IP65

防爆标志: Ex eb q [ia op is Ga] IIC T4 Gb, Ex tb [ia op is Da] IIIC T110°C Db

- 生产者应按照认证机构批准的技术文件组织生产。

2、安全使用条件:

- 人机界面和指点设备之间的本安电路必须等电位连接。
- 在可能产生传播型刷型放电的区域, 不得使用指点设备。
- 本产品认证不包括对光辐射“op is”标准的评价和试验。
- 本安电路接地, 安装时应符合 GB/T3836.15 相关要求。
- 其他见产品使用说明书。

3、证书关联报告:

- 产品型式试验报告: CQST2104C044, CQST2104C044/01

颁发日期: 2023 年 04 月 29 日

主任:



南阳防爆电气研究所有限公司



网址: www.ccc-cnex.com
ccc.china-ex.com

地址: 中国河南省南阳市仲景北路20号
电话: 0377-63239734

邮政编码: 473008
邮箱: ccc@cn-ex.com



中国国家强制性产品认证证书 (附页)

编 号：2021312309000500

第 8 页 共 8 页

- 工厂检查报告：CN2023Q030119

3、证书变更信息：

- 2022 年 04 月 28 日第 1 次变更，变更内容为：型号命名规则变更。
- 2023 年 04 月 29 日第 2 次变更：产品认证依据标准变更。

颁发日期：2023 年 04 月 29 日

主任：



南阳防爆电气研究所有限公司



网址：www.ccc-cnex.com
ccc.china-ex.com

地址：中国河南省南阳市仲景北路20号
电话：0377-63239734

邮政编码：473008
邮箱：ccc@cn-ex.com

23.3 RCM

Supplier's declaration of conformity



As required by the following Notices:

- > *Radiocommunications (Compliance Labelling - Devices) Notice 2014* made under section 182 of the *Radiocommunications Act 1992*;
- > *Radiocommunications Labelling (Electromagnetic Compatibility) Notice 2017* made under section 182 of the *Radiocommunications Act 1992*
- > *Radiocommunications (Compliance Labelling – Electromagnetic Radiation) Notice 2014* made under section 182 of the *Radiocommunications Act 1992* and
- > *Telecommunications (Labelling Notice for Customer Equipment and Customer Cabling) Instrument 2015* made under section 407 of the *Telecommunications Act 1997*.

Instructions for completion

- > *Do not return this form to the ACMA.* This completed form must be retained by the supplier as part of the documentation required for the compliance records and must be made available for inspection by the ACMA when requested.

Supplier's details (manufacturer, importer or authorised agent)

Company Name (OR INDIVIDUAL)

R. STAHL Australia Pty Ltd
TRADING AS R. STAHL HMI Systems GmbH

ACN/ARBN

ABN 81150955838

OR

New Zealand IRDN

--

Street Address (AUSTRALIAN or NEW ZEALAND)

848 Old Princes Highway
Sutherland, NSW
POSTCODE 2232
Phone: +61 2 4254 4777

Product details and date of manufacture

Product description – brand name, type, current model, lot, batch or serial number (if available), software/firmware version (if applicable)

<p>Operating and Monitoring Devices</p> <p>Display Unit T-EX-##*-CAT7*; Display Unit T-EX-##*-MM*; Display Unit T-EX-##*-SM*; * =any alphanumeric or symbolic character; # =one numeric character</p>
<p>Operating and Monitoring Devices</p> <p>Display Unit MT-##7*-CAT7*; Display Unit MT-##7*-MM*; Display Unit MT-##7*-SM*; * =any alphanumeric or symbolic character; # =one numeric character</p>
<p>Keyboard</p> <p>Keyboard Trackball Unit T-EX*-KB-TB*; Keyboard Mouse Unit T-EX*-KB-M*; Keyboard Pad Unit T-EX*-KB-P*; Keyboard Joystick Unit T-EX*-KB-J*; * =any alphanumeric or symbolic character</p>
<p>Transmission Unit</p> <p>Transmission Unit T-EX-KVM*-CAT7*; Transmission Unit T-EX-KVM*-MM*; Transmission Unit T-EX-KVM*-SM*; * =any alphanumeric or</p>

symbolic character

Compliance – applicable standards and other supporting documents

Evidence of compliance with applicable standards may be demonstrated by test reports, endorsed/accredited test reports, certification/competent body statements.

Having had regard to these documents, I am satisfied the above mentioned product complies with the requirements of the relevant ACMA Standards made under the *Radiocommunications Act 1992* and the *Telecommunications Act 1997*.

List the details of the documents the above statement was made, including the standard title, number and, if applicable, number of the test report/endorsed test report or certification/competent body statement

EN 61000-6-4:2007; EN 61000-6-4:2007 + A1:2011

Declaration

I hereby declare that:

1. I am authorised to make this declaration on behalf of the Company mentioned above,
2. the contents of this form are true and correct, and
3. the product mentioned above complies with the applicable above mentioned standards and all products supplied under this declaration will be identical to the product identified above.

Note: Under section 137.1 of the *Criminal Code Act 1995*, it is an offence to knowingly provide false or misleading information to a Commonwealth entity.
Penalty: 12 months imprisonment

	Managing Director
SIGNATURE OF SUPPLIER OR AGENT	POSITION IN ORGANISATION
John Zagame	2018-10-15
PRINT NAME	DATE

The *Privacy Act 1988* (Cth) (the Privacy Act) imposes obligations on the ACMA in relation to the collection, security, quality, access, use and disclosure of personal information. These obligations are detailed in the Australian Privacy Principles.

The ACMA may only collect personal information if it is reasonably necessary for, or directly related to, one or more of the ACMA's functions or activities.

The purpose of collecting the personal information in this form is to ensure the supplier is identified in the 'Declaration of conformity'. If this Declaration of Conformity is not completed and the requested information is not provided, a compliance label cannot be applied.

Further information on the Privacy Act and the ACMA's Privacy Policy is available at www.acma.gov.au/privacypolicy. The Privacy Policy contains details about how you may access personal information about you that is held by the ACMA, and seek the correction of such information. It also explains how you may complain about a breach of the Privacy Act and how we will deal with such a complaint.

Should you have any questions in this regard, please contact the ACMA's privacy contact officer on telephone on 1800 226 667 or by email at privacy@acma.gov.au.

24 Release notes

This chapter lists the changes made in the most recent versions of these Operating Instructions.

Version 01.03.27

- Removal of all previous release notes
- Addition of HW-Ref 01.03.08 for ET-477-*-PB and ET-577-*-PB devices at cover
- Addition of text in section "Processor types"
- Addition in table "Overview hardware revision"
- Exclusion of audio, video, O30 option for processor E3940 in "Technical data"
- Addition of technical data for ET-477-*-PB and ET-577-*-PB devices
- Removal of FSB notice
- Removal of EAC certification
- Removal of EAC Ex classification
- Removal of EAC declaration of conformity
- Renew of PESO certification, new certification number
- Addition of notice for FO interfaces at "Technical data"
- Addition of notice for FO interfaces at "Connections"
- Addition of "Location classes" for DNV approved devices in "Technical data"
- Addition of type code for ET-477-*-PB and ET-577-*-PB devices
- Exclusion of audio, video option for processor E3940 in "Connections"
- Addition of information for processor E3940 in notice in "Connections"
- Addition of processor E3940 in "Teaming function"
- Addition at "Teaming function" notice according to SERIES 400
- Addition of "notice on approval restrictions" for device versions ET-477-*-PB and ET-577-*-PB in section "Certificates"
- Addition of ET-477-*-PB and ET-577-*-PB devices in notice "BIS" in section "Certificates"
- Addition of information on "Windows 10 IoT Enterprise 2021 LTSC operating system" in section "General information"
- Addition of "2019 LTSC" and "Remote Firmware V6" for operating system in the sections "Hardware revision 01.03.03"
- Addition of "2021 LTSC" and "Remote Firmware V7" for operating system in the sections "Hardware revision 01.03.08"
- Correction of CE / ATEX listing in section "Certificates"
- Formal changes

Version 01.03.28

- Update BIS certification
- Renaming CEC into CE-Code
- Addition of directions according to CE in section "Certificates"
- Correction of information according to "Teaming" at ATOM 3940
- Correction in table "Overview hardware revision" changing device type at HW-Rev 01.03.08 now "ET-xx7-*-PB-*
- Correction of information according to "Resolution with DVI3"
- Formal changes

R. STAHL HMI Systems GmbH
Adolf-Grimme-Allee 8
D 50829 Köln

T:	(Sales Support)	+49 221 768 06 - 1200
	(Technical Support)	+49 221 768 06 - 5000
F:		+49 221 768 06 - 4200
E:	(Sales Support)	sales.dehm@r-stahl.com
	(Technical Support)	support.dehm@r-stahl.com

r-stahl.com



THE STRONGEST LINK.