

# Position Switches

## Series 8060



www.stahl.de



11078E00

- > Enclosures of type of protection "increased safety"
- > Dimensions and characteristic values according to EN 50047
- > Replaceable contact in flameproof enclosure
- > Positive opening contacts
- > Category 1 safety position switch with a variable system of actuators
- > All inserts may be displaced by 4 x 90°
- > Contacts with:
  - Snap-action contact
  - Slow-action contact
  - Make before break slow-action contact
- > Possible as version with unconnected cable end



E4

Position switches are used to monitor the position of moving parts of machines and systems. They can be used in safety circuits as the device satisfies the standard EN 60947-5-1 (VDE 0660 Part 200) and the normally closed contacts are positive opening contacts. The switching element and the actuating element of category 1 safety switches form a constructional and functional unit. As a result of the galvanic isolation of the moving contacts, the position switch is suitable for switching various potentials.







	ATEX / IECEx					
Zone	0	1	2	20	21	22
For use in		x	x		x	x

**WebCode 8060A**

## Position Switches

### Series 8060

Selection Table

Version	Actuator		Order number	Weight kg
 09387E00	Roller plunger	Roller of moulded material	<b>8060/1-.-RS</b>	0.073
 09388E00	Roller lever plunger, form E	Roller of moulded material	<b>8060/1-.-AR</b>	0.074
 09393E00	Angled roller lever	Roller of moulded material	<b>8060/1-.-WR</b>	0.074
 09389E00	Swivelling roller lever, form A	Roller of moulded material	<b>8060/1-.-R</b>	0.085
 09390E00	Adjustable roller lever	Roller of moulded material Roller rod of stainless steel	<b>8060/1-.-V</b>	0.104
 09391E00	Actuating rod	Rod of moulded material  <b>No positive opening, not suitable for safety circuits</b>	<b>8060/1-.-H</b>	0.097
 09392E00	Spring-rod actuator	Spring of stainless steel Only for use with snap-action contact!  <b>No positive opening, not suitable for safety circuits</b>	<b>8060/1-2-F</b>	0.085

#### Order Number Supplement

Switching function	1 NC + 1 NO	Slow-action contact	<b>8060/1-1-...</b>	
	2 NC	Slow-action contact	<b>8060/1-3-...</b>	
	2 NO	Slow-action contact	<b>8060/1-4-...</b>	
	1 NC + 1 NO	Slow-action contact, make before break	<b>8060/1-5-...</b>	
	1 NC + 1 NO	Snap-action contact, with spring	<b>8060/1-2-...</b>	
		Version with unconnected cable end		<b>8060/1-.-.-.-K</b>

Note The actuators enclosed are not mounted

# Position Switches

## Series 8060



### Explosion Protection

#### Marking

IECEX	
Gas explosion protection	Ex de IIC T6
Dust explosion protection	Ex tD A21 IP65 T80°C
Europe (ATEX)	
Gas explosion protection	⊕ II 2 G Ex de IIC T6
Dust explosion protection	⊕ II 2 D Ex tD A21 IP65 T80°C

#### Certificates

IECEX	IECEX PTB 06.0091
Europe (ATEX)	
Gas explosion protection	PTB 01 ATEX 1052
Dust explosion protection	PTB 01 ATEX 1052
Further certificates	India (PESO), Canada (CSA), Kazakhstan (JSC), Russia (CTB), Belarus (Gospromnadzor), Ukraine (IECVE)

### Technical Data

#### Electrical Data

Rated operational voltage $U_e$	8060/1-1		8060/1-3	
	8060/1-2		8060/1-4	
Rated operational current $I_e$	max. 10 A		max. 10 A	
	max. 10 A		max. 10 A	
Switching capacity	AC-12		DC-12	
	AC-15		DC-12	
Rated insulation voltage	550 V		550 V	
	6 kV		6 kV	
Rated impulse withstand voltage	10 A gG		10 A gG	
	10 A gG		10 A gG	

#### Ambient Conditions

Operating temperature range	- 20 ... + 50 °C (10 A)
	- 20 ... + 70 °C (6 A)

#### Mechanical Data

Maximum switching frequency	max. 6000 operations/h
Degree of protection	IP65
Enclosure material	Polyamide, glass fibre reinforced, black
Mechanical shock resistance	Snap-action contact: 2 g
	Slow-action contact: 20 g

#### Mounting / Installation

Cable glands	8161/5-M20-13
Connection	at the bottom of the enclosure: 1 x M20 x 1.5
	With cable glands 8161: For plastic sheathed cable 4 x 2.5 mm <sup>2</sup> (diameter 6 ... 13 mm); recommended 4 x 1.5 mm <sup>2</sup>
Terminals	With mounted connecting cable: Plastic sheathed cable HK-SO-X05VV-F-OZ 4 x 1.5 mm, cable length 6 m
	1 x 2.5 mm <sup>2</sup> or 2 x 1 mm <sup>2</sup> , single-wire / finely-stranded
Tightening torque	Screw terminals: max. 0.4 Nm
	Cover screws: max. 0.7 Nm
	Connection thread: 2.3 Nm (M20 x 1.5)
	Pressure screw: 1.5 Nm (M20 x 1.5)

E4

# Position Switches

## Series 8060

### Technical Data

#### Contact

Version

Slow-action contact

Snap-action contact

Slow-action contact, make before break

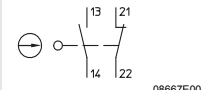

8060/1-1 08667E00

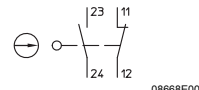

8060/1-2 08668E00

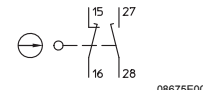

8060/1-5 08675E00

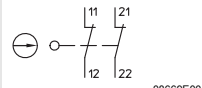

8060/1-3 08669E00

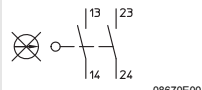

8060/1-4 08670E00

Attention:  
The positive opening function ⊖ depends on the actuator used

Contact arrangement

Contact opening

Contacts

Service life

Mechanical

electrical

Enclosure contact

2-pole, galvanically isolated, with double break action  
≥ 1.5 mm (isolating distance ≥ 3 mm)

Silver-nickel

max. 10<sup>6</sup> operations

max. 10<sup>6</sup> operations

Polyamide, glass fibre reinforced

### Technical Data

Operation, operating speed, contact travel or angle

Actuator	Operation	Diagram	Nominal contact travels or angles	Minimum force/torque
Type 8060/1	V = Max. operating speed → = Direction of operation ( ) = Connection for device with unconnected cable end	⊖ = Positive opening	■ = Contact closed □ = Contact open Zw = Travel for positive opening	
Roller plunger 8060/1- . -RS	<p>08084E00</p> <p>Lateral operation: V = 1.0 m/s</p>	<p>07695E00</p> <p>07696E00</p> <p>07697E00</p> <p>07698E00</p>	<p>In stroke direction</p> <p>8060/1-1:</p> <p>07705E01</p> <p>8060/1-2:</p> <p>07722E01</p> <p>8060/1-3:</p> <p>07706E01</p> <p>8060/1-4:</p> <p>07707E01</p>	14 N

# Position Switches

## Series 8060



### Technical Data

Operation, operating speed, contact travel or angle

Actuator	Operation	Diagram	Nominal contact travels or angles	Minimum force/torque
Type 8060/1	<p>V = Max. operating speed                      → = Direction of operation                      () = Connection for device with unconnected cable end</p> <p>Operation in stroke direction:                      V = 1.0 m/s</p>	<p>⊕ = Positive opening</p>	<p>■ = Contact closed                      □ = Contact open                      Zw = Travel for positive opening</p> <p>8060/1-5: </p>	
Roller lever plunger, form E 8060/1- . -AR	<p>V = 1.0 m/s</p>		<p>Movement of the roller in stroke direction of the plunger after plunger starts moving</p> <p>8060/1-1: </p> <p>8060/1-2: </p> <p>8060/1-3: </p> <p>8060/1-4: </p> <p>8060/1-5: </p>	12 N
Angled roller lever 8060/1- . -WR			<p>Movement of the roller vertically to stroke direction of the plunger after plunger starts moving</p> <p>8060/1-1: </p> <p>8060/1-2: </p> <p>8060/1-3: </p>	12 N

E4

# Position Switches

## Series 8060

### Technical Data

Operation, operating speed, contact travel or angle

Actuator	Operation	Diagram	Nominal contact travels or angles	Minimum force/torque
Type 8060/1	<p>V = Max. operating speed                      → = Direction of operation                      () = Connection for device with unconnected cable end</p>	<p>⊕ = Positive opening</p>	<p>■ = Contact closed                      □ = Contact open                      Zw = Travel for positive opening</p>	
Angled roller lever 8060/1- . -WR	V = 1.0 m/s		<p><b>8060/1-4:</b></p> <p>07714E01</p> <p><b>8060/1-5:</b></p> <p>Zw = 8.2 mm 12140E01</p>	
Swivelling roller lever, form A 8060/1- . -R	V = 1.5 m/s	<p>08743E00</p>	<p><b>8060/1-1:</b></p> <p>Zw = 34° 07715E00</p> <p><b>8060/1-2:</b></p> <p>Zw = 42° 07725E00</p> <p><b>8060/1-3:</b></p> <p>Zw = 43° 07717E00</p> <p><b>8060/1-4:</b></p> <p>Zw = 22° 07718E00</p> <p><b>8060/1-5:</b></p> <p>Zw = 45° 07716E00</p>	0.3 Nm

# Position Switches

## Series 8060



### Technical Data

Operation, operating speed, contact travel or angle

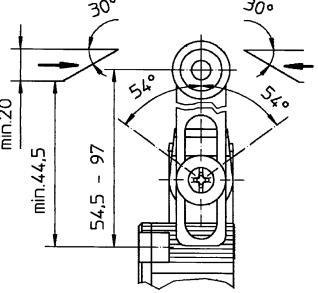
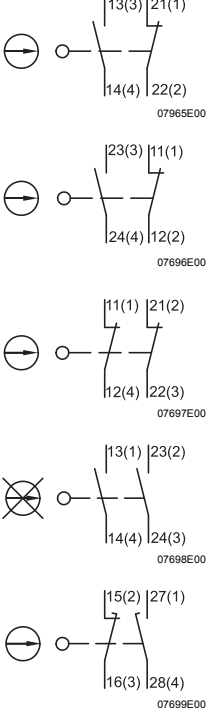
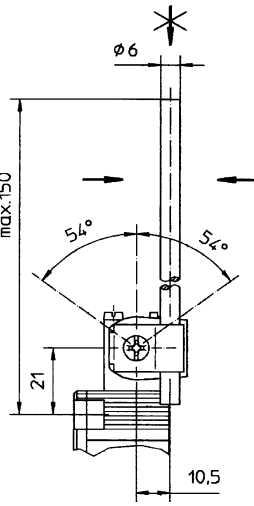
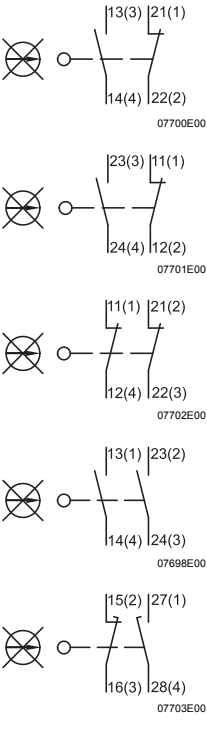
Actuator	Operation	Diagram	Nominal contact travels or angles	Minimum force/torque
Type 8060/1	<p>V = Max. operating speed                      → = Direction of operation                      () = Connection for device with unconnected cable end</p>	<p>⊕ = Positive opening</p>	<p>■ = Contact closed                      □ = Contact open                      Zw = Travel for positive opening</p>	
Adjustable roller lever 8060/1-..-V	 <p>V = 1.5 m/s</p>	<p>⊕ = Positive opening</p> 	<p><b>8060/1-1:</b> 13-14 (3)-(4), 21-22 (1)-(2), Zw = 34°, 0 22° 34° 54°, 07715E00</p> <p><b>8060/1-2:</b> 23-24 (3)-(4), 11-12 (1)-(2), 23-24 (3)-(4), 11-12 (1)-(2), Zw = 42°, 0 7° 25° 54°, 07725E00</p> <p><b>8060/1-3:</b> 11-12 (1)-(4), 21-22 (2)-(3), Zw = 43°, 0 24° 54°, 07717E00</p> <p><b>8060/1-4:</b> 13-14 (1)-(4), 23-24 (2)-(3), Zw = 44°, 0 22° 54°, 07718E00</p> <p><b>8060/1-5:</b> 27-28 (1)-(4), 15-16 (2)-(3), Zw = 45°, 0 19° 31° 54°, 07716E00</p>	0.3 Nm
Actuating rod 8060/1-..-H	 <p>V = 1.5 m/s</p>	<p>⊗ = Negative opening</p> 	<p><b>8060/1-1:</b> 13-14 (3)-(4), 21-22 (1)-(2), Zw = 34°, 0 22° 34° 54°, 07719E00</p> <p><b>8060/1-2:</b> 23-24 (3)-(4), 11-12 (1)-(2), 23-24 (3)-(4), 11-12 (1)-(2), Zw = 42°, 0 7° 25° 54°, 07726E00</p> <p><b>8060/1-3:</b> 11-12 (1)-(4), 21-22 (2)-(3), Zw = 43°, 0 25° 54°, 07721E00</p> <p><b>8060/1-4:</b> 13-14 (1)-(4), 23-24 (2)-(3), Zw = 44°, 0 22° 54°, 07718E00</p> <p><b>8060/1-5:</b> 27-28 (1)-(4), 15-16 (2)-(3), Zw = 45°, 0 19° 31° 54°, 07720E00</p>	0.3 Nm

E4

# Position Switches



## Series 8060

### Technical Data

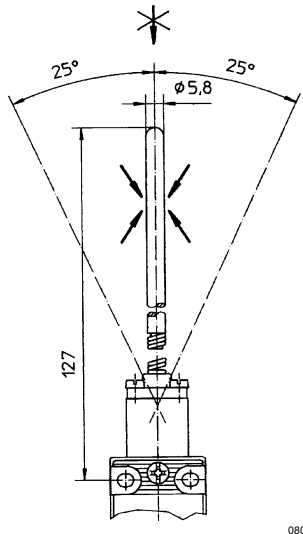
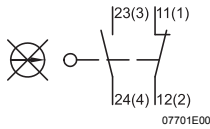
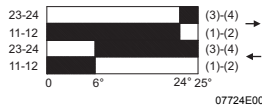
Operation, operating speed, contact travel or angle

Actuator	Operation	Diagram	Nominal contact travels or angles	Minimum force/torque
Type 8060/1	V = Max. operating speed → = Direction of operation () = Connection for device with unconnected cable end	⊖ = Positive opening	■ = Contact closed □ = Contact open Zw = Travel for positive opening	
Actuating rod 8060/1- . -H	No positive opening, not suitable for safety circuits			
Spring-rod actuator 8060/1-2-F	 <p>No positive opening, not suitable for safety circuits</p>		Only for use with snap-action contact! -- 8060/1-2: 	

### Accessories and Spare Parts

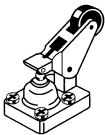
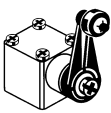
Designation	Illustration	Description	Art. no.	Weight kg	
Actuator	 05663E00	Roller plunger	8060/1-0-RS	<b>131254</b>	0.019
	 05664E00	Roller lever plunger, form E	8060/1-0-AR	<b>131257</b>	0.020
	 05669E00	Angled roller lever	8060/1-0-WR	<b>131272</b>	0.021
	 05665E00	Swivelling roller lever, form A	8060/1-0-R	<b>131260</b>	0.034





# Position Switches

## Series 8060

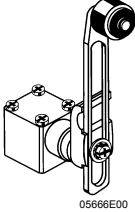
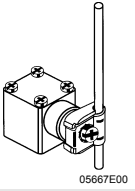
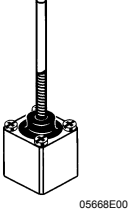

### Accessories and Spare Parts

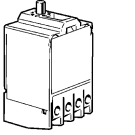
Designation	Illustration	Description	Art. no.	Weight kg
Actuator	 05668E00	Adjustable roller lever 8060/1-0-V	<b>131263</b>	0.052
	 05667E00	Actuating rod 8060/1-0-H	<b>131266</b>	0.045
	 05668E00	Spring-rod actuator <b>Only for use with snap-action contact!</b> 8060/1-0-F	<b>131269</b>	0.034
Cable gland	 05864E00	8161/5-M20-13 1 piece	<b>138518</b>	0.012
Contact	 10809E00	1 NC + 1 NO Slow-action contact 8080/1-1	<b>132529</b>	0.025
		2 NC Slow-action contact 8080/1-3	<b>132532</b>	0.025
		2 NO Slow-action contact 8080/1-4	<b>132533</b>	0.025
		1 NC + 1 NO Slow-action contact, make before break 8080/1-5	<b>132534</b>	0.025
		1 NC + 1 NO Snap-action contact 8080/1-2	<b>132531</b>	0.025

E4

### Dimensional Drawings (All Dimensions in mm) - Subject to Alterations

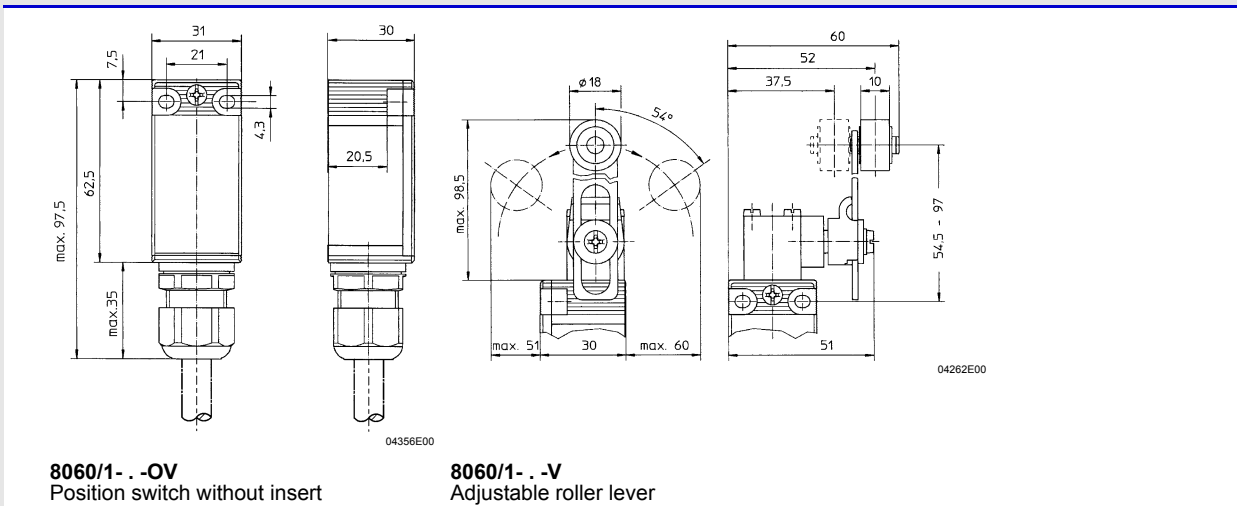

# Position Switches

## Series 8060

### Dimensional Drawings (All Dimensions in mm) - Subject to Alterations

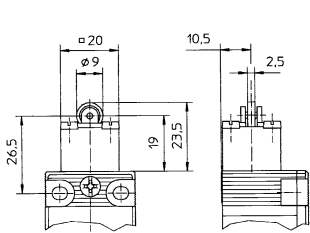

04259E00

**8060/1-.-RS**  
Roller plunger

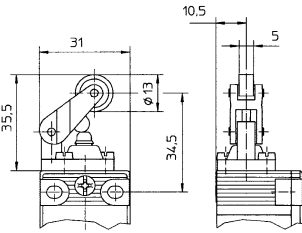

04260E00

**8060/1-.-AR**  
Roller lever, form E

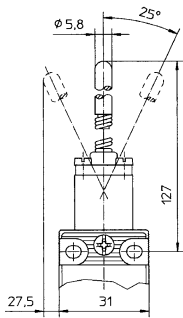

04264E00

**8060/1-2-F**  
Spring rod actuator

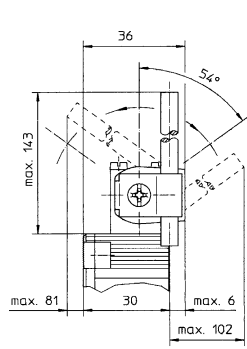
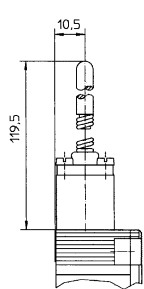

04263E00

**8060/1-.-H**  
Actuating rod

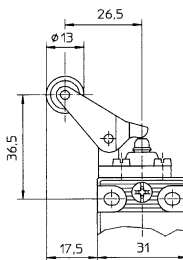
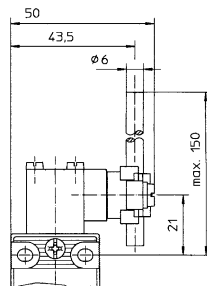

04265E00

**8060/1-.-WR**  
Angled roller lever

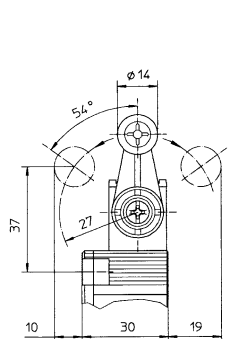
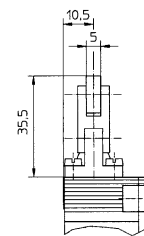

04261E00

**8060/1-.-R**  
Swivelling roller lever, form A

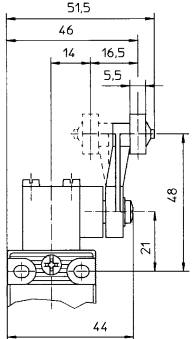

We reserve the right to make alterations to the technical data, dimensions, weights, designs and products available without notice. The illustrations cannot be considered binding.