

Lighting

Linear luminaire With LED

GRP industrial design

L402/4348-6120-152-1110-11-8400 Art. No. 276557



- Highly resistant industrial design
- Linear luminaire with long-life, efficient LED technology (up to 138 lm/W)
- Lightweight yet extremely robust, with an impact strength rating of IK10

MY R. STAHL L402A

The EXLUX L402/4 luminaire is designed for industrial use and can be fitted to the ceiling, a pole, or alternatively, it can be suspended. A bright light for not much energy is what you get with this efficient LED technology, which offers the added benefit of increased service life – this can be as much as 100,000 hours. The plastic enclosure is easily to open by a central lock.

Technical Data

Explosion Protection

Ex version	Industrial design
------------	-------------------

Electrical Data

Rated operational voltage AC	220 ... 230 V
------------------------------	---------------

Rated operational voltage DC	194 ... 250 V
------------------------------	---------------

Frequency range	50 – 50Hz
-----------------	-----------

Lighting Data

Number of lamps	1
-----------------	---

Lamp wattage	42 W
--------------	------

Lamp	LED
------	-----

Light colour	4000 K – warm neutral white
--------------	-----------------------------

Light distribution	120°x120° with diffusing glass
--------------------	--------------------------------

Luminaire efficacy	138 lm/W
--------------------	----------

Luminous flux	5810 lm
---------------	---------

Colour rendering	≥ 80
------------------	------

Colour temperature	4000 K
--------------------	--------

Ambient Conditions

Ambient temperature	-30 °C ... 45 °C Note: Through wiring Max. 3x16 A -30 °C ... 50 °C Note: Through wiring 2 Max. 3x10 A
---------------------	--

Note	Through wiring max. 3x16 A Ambient temperature °C -40 °C ... +55 °C Through wiring 2 max. 3x10 A Ambient temperature °C 2 -40 ... +60 °C
------	---

Mechanical Data

Version	Standard
---------	----------

IP degree of protection (IEC 60598)	IP66/IP67
-------------------------------------	-----------

Class	I (with inner PE connection)
-------	------------------------------

Enclosure material	Polyester resin, Glass fibre reinforced
--------------------	---

Lighting

Linear luminaire With LED

GRP industrial design

L402/4348-6120-152-1110-11-8400 Art. No. 276557



Mechanical Data

Enclosure colour	Light grey (RAL 7035)
Diffuser	With diffuser
Sealing material	Silicone
Silicone-free content	Contains silicone
Translucent cover material	Polycarbonate
Installed terminal strip	PE + N- + L+ + N' + L'
Max. solid connection terminals	6 mm ²
Max. finely stranded connection terminals	4 mm ²
Type of connection cable	Finely stranded Solid
Size	4
Width	184 mm
Height	125 mm
Length	1310 mm
Impact strength (IEC 62262)	IK10
Weight	5.6 kg
Weight	12.35 lb
Disconnection of the luminaire	No

Components

Threaded plate	2x plastic
Address module	UNI Modul ADR 20-ILS-Z2
Ballast	VG Luxtronic 40 W 300 mA
Through wiring	With 5 conductors 2.5 mm ²
Drilled holes	3 x M25
Cable glands and entries	2 x M25 Ø 7 ...
Material cable gland	Polyamide, black
Stopping plugs	2 x M25 x 1.5
Stopping plug material	Polyamide, black
Accessories	Provided

Light Distribution Curves

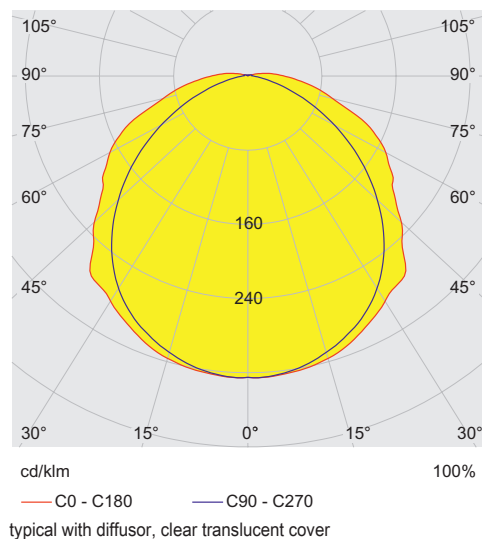

Lighting

Linear luminaire With LED

GRP industrial design

L402/4348-6120-152-1110-11-8400 Art. No. 276557



Dimensional Drawings (All Dimensions in mm [inches]) – Subject to Alterations

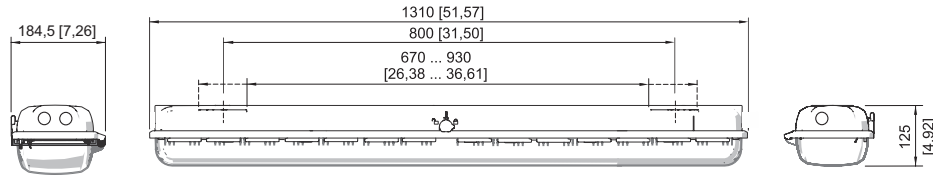

Size 4

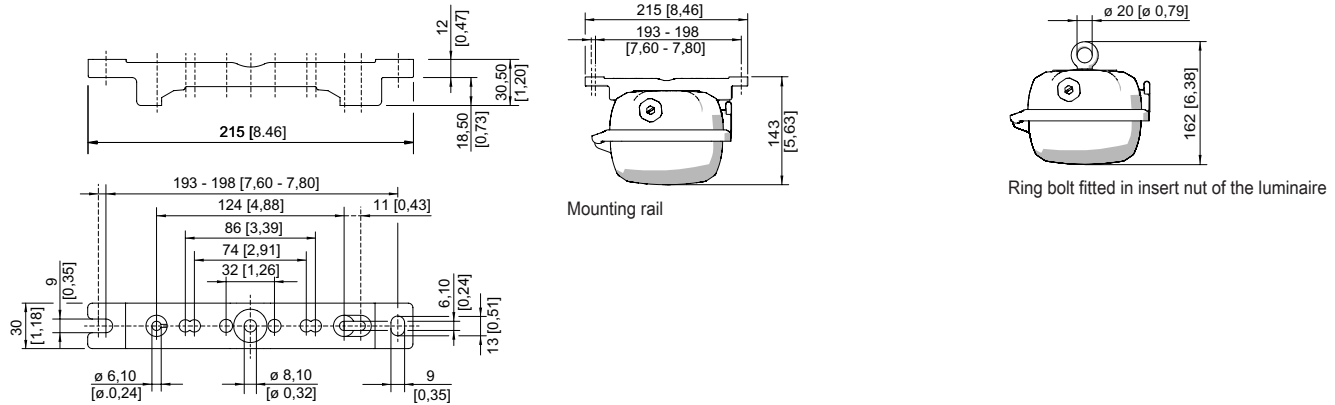

Mounting rail

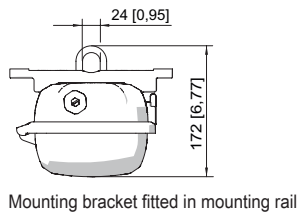

Mounting bracket fitted in mounting rail

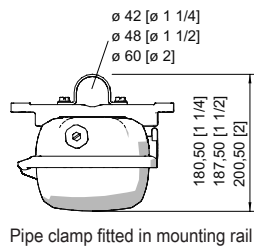

Pipe clamp fitted in mounting rail

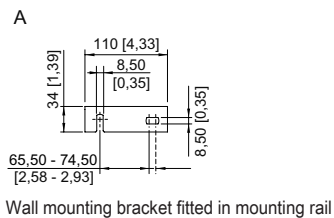
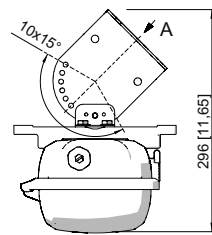

Wall mounting bracket fitted in mounting rail

Accessories

Box spanner

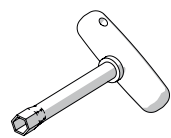

M8 / A/F 13;
For actuating the central lock

Art. No.

222430

Breather

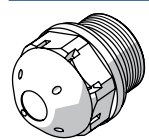

Thread: M25 x 1.5 (20 pieces); without jam nut

Art. No.

285780



Lighting

Linear luminaire With LED

GRP industrial design

L402/4348-6120-152-1110-11-8400 Art. No. 276557

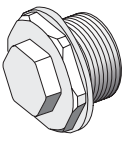
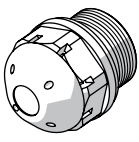
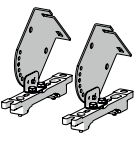
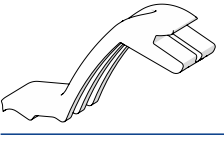
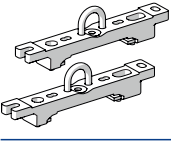
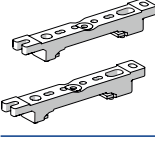
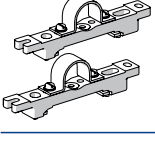

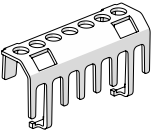
	<p>Thread: M25 x 1.5 (1 piece); for installation in light fittings; made from stainless steel; without jam nut</p>	<p>296608</p>
	<p>M25 x 1.5 in order to avoid condensate formation</p>	<p>115738</p>
<p>Ceiling and wall mounting bracket</p>		<p>Art. No.</p>
	<p>mounted on a mounting rail for a variable mounting distance; Material: stainless steel; Lamp can be swiveled in steps of 15°; 1 pair</p>	<p>222827</p>
<p>Holder for translucent cover</p>		<p>Art. No.</p>
	<p>The fall prevention system for the light fitting cover prevents the light fitting cover from falling accidentally when the light fitting is opened.</p>	<p>226791</p>
<p>Mounting bracket</p>		<p>Art. No.</p>
	<p>mounting clamp mounted on a mounting rail for a variable mounting distance; 1 pair</p>	<p>222456</p>
<p>Mounting rail</p>		<p>Art. No.</p>
	<p>for a variable mounting distance; 1 pair</p>	<p>222826</p>
<p>Pipe clamp</p>		<p>Art. No.</p>
	<p>R 1 1/2"; with mounting rail for a variable mounting distance; material: stainless steel; 1 pair</p>	<p>222459</p>
	<p>R 1 1/4"; with mounting rail for a variable mounting distance; Material: stainless steel; 1 pair</p>	<p>222458</p>
	<p>R 2"; with mounting rail for a variable mounting distance; Material: stainless steel; 1 pair</p>	<p>222460</p>
<p>Pole mounting sleeve</p>		<p>Art. No.</p>
	<p>for the subsequent mounting on lights size 2 and size 4, completely with assembly parts (for pipe diameter 42 mm)</p>	<p>227512</p>
<p>Protection against accidental contact</p>		<p>Art. No.</p>
	<p>The protection against accidental contact prevents maintenance technicians and electrical installers from accidentally touching conductive parts. The degree of protection is increased to IP20 when the protection against accidental contact is used.</p>	<p>283153</p>

Lighting

Linear luminaire With LED

GRP industrial design

L402/4348-6120-152-1110-11-8400 Art. No. 276557



Ring bolt

Art. No.



M8, direct mounting in insert nuts; 1 pair

115736

Spare Parts

Cover

Art. No.

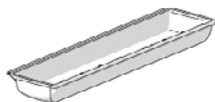

for luminaire size 4

222428

We reserve the right to make alterations to the technical data, dimensions, weights, designs and products available without notice. The illustrations cannot be considered binding.