

Lighting

Linear luminaire With LED

GRP

6002/4148-0100-152-1110-11-8650 Art. No. 277614



- The latest LED technology with a high luminous efficacy and a long service life
- Extremely high luminaire efficacy
- Luminous flux after 100,000 h still 90% of the starting luminous flux
- Optionally with DALI for controlling and monitoring the luminaire
- Optionally addressable for direct actuation of a common battery system

MY R. STAHL 6002D



The linear luminaire with Series 6002/4 LED is ideal for lighting surfaces at a mounting height of up to 10 m. It can also be used to illuminate equipment and objects, both inside and outside. The pole mounting sleeve accessory can be used to easily mount the luminaire on poles. Optionally, the luminaire can be equipped with addressable equipment. It can be used to control and monitor the luminaire for the common battery systems.

Technical Data

Explosion Protection

| | |
|---------------------------------|---|
| Ex version | Yes |
| Application range (zones) | 1, 2, 21, 22 |
| IECEX gas certificate | IECEX IBE 14.0035 |
| IECEX gas certificate | IECEX IBE 14.0035 |
| IECEX gas explosion protection | Ex db eb ib op is IIC T4 Gb |
| IECEX dust certificate | IECEX IBE 14.0035 |
| IECEX dust explosion protection | Ex tb op is IIIC T100 °C Db |
| ATEX gas certificate | IBExU 14ATEX1088 |
| ATEX gas certificate | IBExU 14ATEX1088 |
| ATEX gas explosion protection | Ex II 2 G Ex db eb ib op is IIC T4 Gb |
| ATEX dust certificate | IBExU 14ATEX1088 |
| ATEX dust explosion protection | Ex II 2 D Ex tb op is IIIC T100 °C Db |
| Certificates and approvals | ATEX IECEX UKEX |
| Certificates | ATEX (IBE), IECEX (IBE), India (PESO) |
| Ship approval | DNV |
| Declaration of Conformity | ATEX (EUK), Declaration of Conformity (AUS) |

Electrical Data

| | |
|------------------------------|---------------|
| Rated operational voltage AC | 100 ... 240 V |
| Rated operational voltage DC | 110 ... 250 V |
| Frequency range | 50 – 60Hz |

Lighting Data

| | |
|-----------------|------|
| Number of lamps | 1 |
| Lamp wattage | 42 W |
| Lamp | LED |

Lighting Data

| | |
|--------------------|--------------------------------|
| Light colour | 6500 K – daylight white |
| Light distribution | 120°x120° with diffusing glass |
| Luminaire efficacy | 138 lm/W |
| Luminous flux | 5810 lm |
| Colour rendering | ≥ 80 |
| Colour temperature | 6500 K |

Ambient Conditions

| | |
|---------------------|--|
| Ambient temperature | -40 °C ... 50 °C Note: Through wiring Max. 3x16 A -40 °C ... 60 °C Note: Through wiring 2 Max. 3x10 A |
|---------------------|--|

Mechanical Data

| | |
|---|---|
| Version | Standard |
| Translucent cover | Clear |
| IP degree of protection (IEC 60598) | IP66/IP67 |
| Enclosure material | Polyester resin, Glass fibre reinforced |
| Enclosure colour | Light grey (RAL 7035) |
| Diffuser | With diffuser |
| Sealing material | Silicone |
| Silicone-free content | Contains silicone |
| Translucent cover material | Polycarbonate |
| Installed terminal strip | PE + N + L1 + L2 + L3 |
| Max. solid connection terminals | 6 mm ² |
| Max. finely stranded connection terminals | 4 mm ² |
| Type of connection cable | Finely stranded Solid |
| Size | 4 |
| Width | 184 mm |
| Height | 125 mm |
| Length | 1310 mm |
| Impact strength (IEC 62262) | IK10 |
| Weight | 6.9 kg |
| Weight | 15.21 lb |
| Disconnection of the luminaire | No |

Components

| | |
|--------------------------|---------------------------------------|
| Threaded plate | 2x plastic |
| Ballast | 6045/311-120-10 |
| Through wiring | With 5 conductors 2.5 mm ² |
| Drilled holes | 3 x M25 |
| Cable glands and entries | 2 x M25 Ø 7 ... |
| Material cable gland | Polyamide, black |
| Stopping plugs | 2 x M25 x 1.5 |
| Stopping plug material | Polyamide, black |
| Accessories | Provided |

Light Distribution Curves

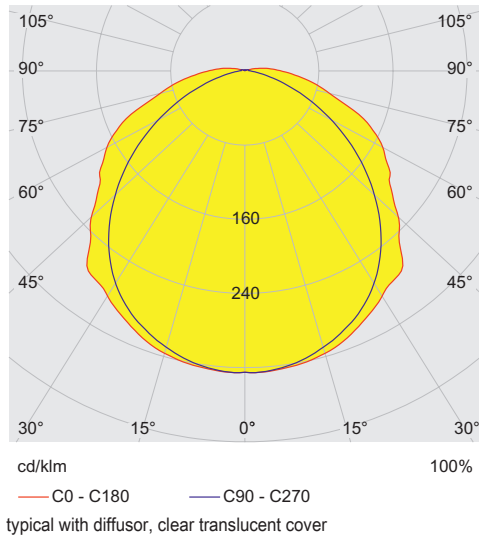

Dimensional Drawings (All Dimensions in mm [inches]) – Subject to Alterations

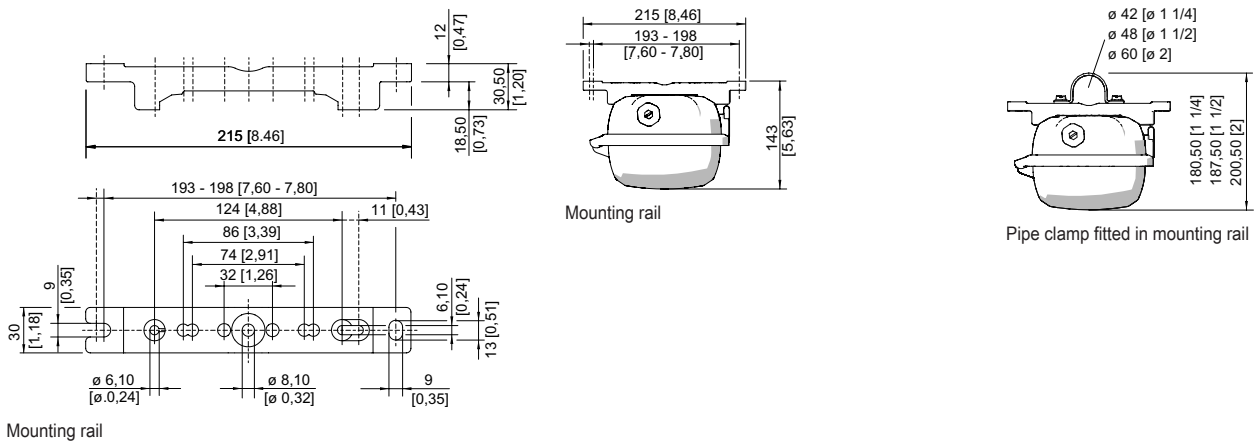
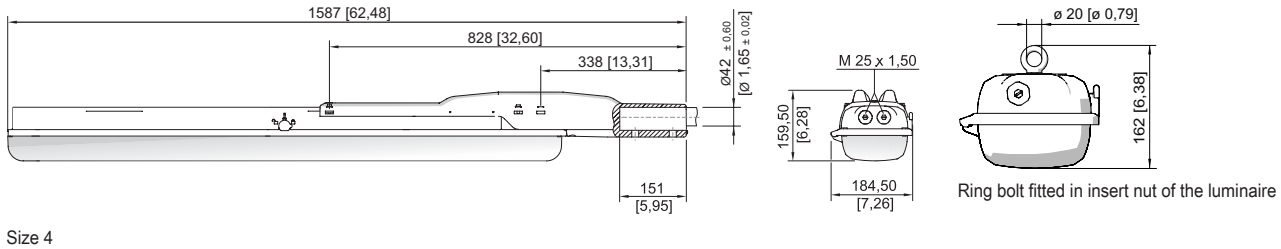
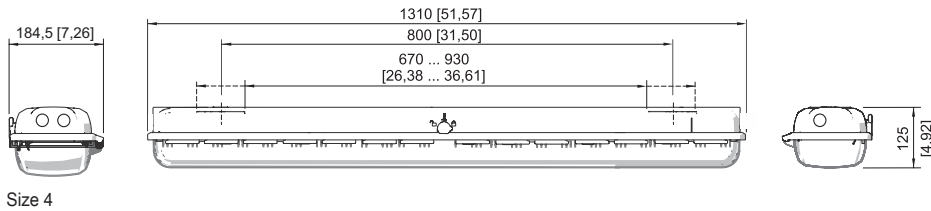

Lighting

Linear luminaire With LED

GRP

6002/4148-0100-152-1110-11-8650 Art. No. 277614



Mounting bracket fitted in mounting rail



Wall mounting bracket fitted in mounting rail

Accessories

Box spanner

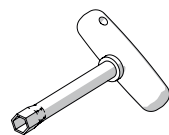

M8 / A/F 13;
For actuating the central lock

Art. No.

222430

Breather

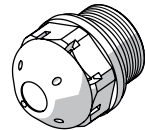

Thread: M25 x 1.5 (20 pieces); without jam nut

Art. No.

285780

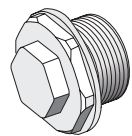

Thread: M25 x 1.5 (1 piece); for installation in light fittings; made from stainless steel; without jam nut

296608

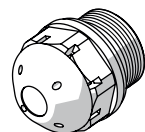

M25 x 1.5 in order to avoid condensate formation

115738

Ceiling and wall mounting bracket

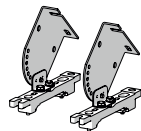

mounted on a mounting rail for a variable mounting distance; Material: stainless steel; Lamp can be swiveled in steps of 15°; 1 pair

Art. No.

222827

Holder for translucent cover



The fall prevention system for the light fitting cover prevents the light fitting cover from falling accidentally when the light fitting is opened.

Art. No.

226791

Lighting

Linear luminaire With LED

GRP

6002/4148-0100-152-1110-11-8650 Art. No. 277614

STAHL

Mounting bracket

Art. No.



mounting clamp mounted on a mounting rail for a variable mounting distance; 1 pair

222456

Mounting rail

Art. No.

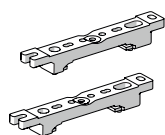

for a variable mounting distance; 1 pair

222826

Pipe clamp

Art. No.

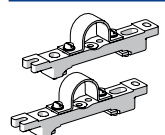

R 1 1/2"; with mounting rail for a variable mounting distance; material: stainless steel; 1 pair

222459

R 1 1/4"; with mounting rail for a variable mounting distance; Material: stainless steel; 1 pair

222458

R 2"; with mounting rail for a variable mounting distance; Material: stainless steel; 1 pair

222460

Pole mounting sleeve

Art. No.



for the subsequent mounting on lights size 2 and size 4, completely with assembly parts (for pipe diameter 42 mm)

227512

Protection against accidental contact

Art. No.



The protection against accidental contact prevents maintenance technicians and electrical installers from accidentally touching conductive parts. The degree of protection is increased to IP20 when the protection against accidental contact is used.

283153

Ring bolt

Art. No.



M8, direct mounting in insert nuts; 1 pair

115736

Spare Parts

Cover

Art. No.

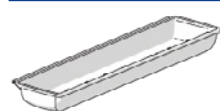

for luminaire size 4

222428

Reflector Plate

Art. No.

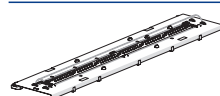

Spare part for 6002 or upgrade 6001 size 4, colour temperature 6500 K

272065

We reserve the right to make alterations to the technical data, dimensions, weights, designs and products available without notice. The illustrations cannot be considered binding.