

6125/2124-1501-6011-331 Art. No. 282392



- LED high-power floodlight with power consumption of up to 225 W
- Wide-range voltage input between 110 V and 277 V (50 Hz and 60 Hz)
- Suitable for operation in central battery systems and DC mains (176 V to 264 V DC)
- Three wattage classes are available: 100 W, 160 W and 225 W
- An enclosure made from stainless steel 316L is also available for marine and offshore applications.
- Optionally available with DALI interface

MY R. STAHL 6125B



The new generation of LED floodlights for Zone 1 also relies on the tried-and-tested, robust stainless steel enclosure (optionally seawater-resistant stainless steel 316L). However, thanks to their smaller design and a new generation of drivers, they weigh significantly less, thereby improving ergonomics during installation and operation. Now with three power classes and the three tried-and-tested light distribution curves, the LED floodlight generates three colours of LED light – warm white, neutral white and cold white.

Technical Data

Explosion Protection	
Application range (zones)	1, 2, 21, 22
IECEX gas certificate	IECEX EPS 15.0087
IECEX gas explosion protection	Ex db eb op is IIC T4 Gb
IECEX dust certificate	IECEX EPS 15.0087
IECEX dust explosion protection	Ex tb op is IIIC T100 °C Db
ATEX gas certificate	EPS 15 ATEX 1 114
ATEX gas explosion protection	Ex II 2 G Ex db eb op is IIC T4 Gb
ATEX dust certificate	EPS 15 ATEX 1 114
ATEX dust explosion protection	Ex II 2 D Ex tb op is IIIC T100 °C Db
Certificates	ATEX (BVIS), Brazil (ULB), IECEx (BVIS), India (PESO)
Declaration of conformity	ATEX (EUK)
Electrical Data	
Rated operational voltage AC	110 ... 277 V
Frequency range	50 – 60 Hz
Lighting Data	
Lamp wattage	100 W
Lamp type	LED
Lamp	LED
Light colour	Cool white
Light distribution	Wide beam
Luminaire efficacy	116 lm/W
Luminous flux	11574 lm
Colour rendering	≥ 70
Colour temperature	5700 K

6125/2124-1501-6011-331 Art. No. 282392

Ambient Conditions

Ambient temperature	-50 °C ... +60 °C
Storage temperature	-40 °C ... +75 °C

Mechanical Data

Degree of protection (IP)	IP66
Class	I
Enclosure material	Stainless steel 1.4301, Powder-coated Single-layer powder-coated
Enclosure colour	Similar to RAL 9010
Sealing material	Silicone
Pane material	Reinforced glass
Max. solid connection terminals	6 mm ²
Max. finely stranded connection terminals	4 mm ²
Type of connection cable	Finely stranded Solid
Width	400 mm
Height	70 mm
Length	520 mm
Impact strength (IEC 62262)	IK10
Mounting	With bracket, SS304
Weight	16.5 kg
Weight	36.38 lb

Mounting / Installation

Note about mounting	Provided
---------------------	----------

Components

Drilled holes	3 x M25
Cable glands and entries	1 x M25 x 1.5 CMP-25A2F
Material cable gland	Nickel-plated brass
Stopping plugs	2 x M25 x 1.5
Stopping plug material	Polyamide, black

Light Distribution Curves



cd/klm 100%
 — C0 - C180 — C90 - C270
 typ. broad beam

6125/2124-1501-6011-331 Art. No. 282392

Dimensional Drawings (All Dimensions in mm [inches]) – Subject to Alterations

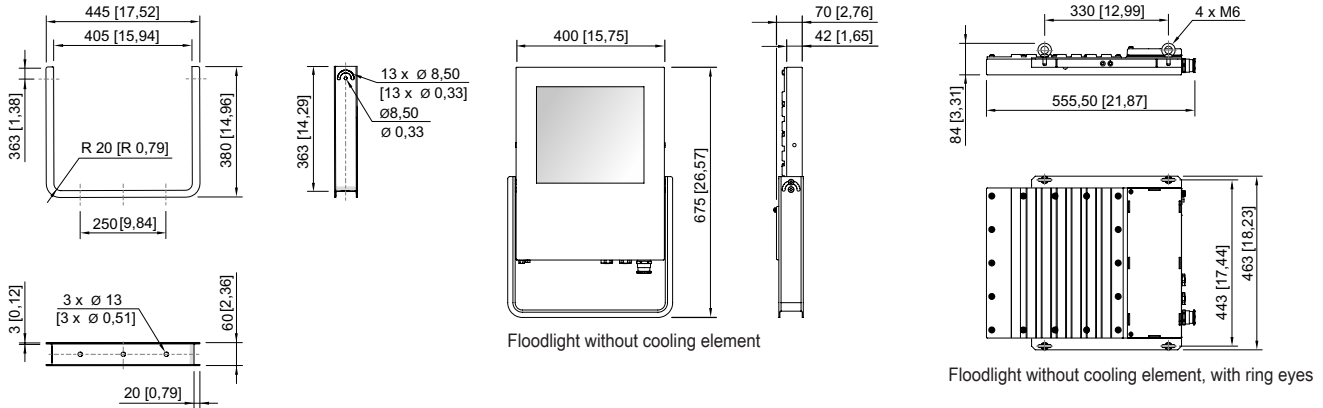

Mounting bracket

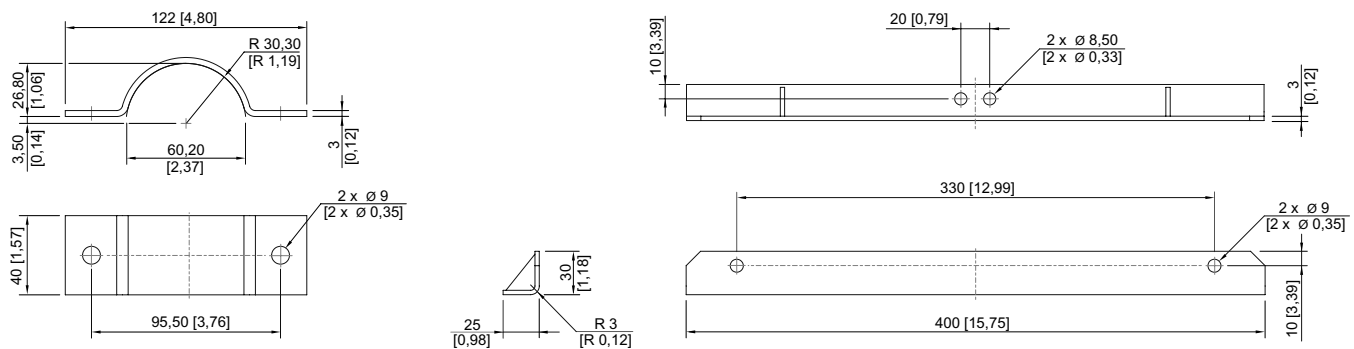
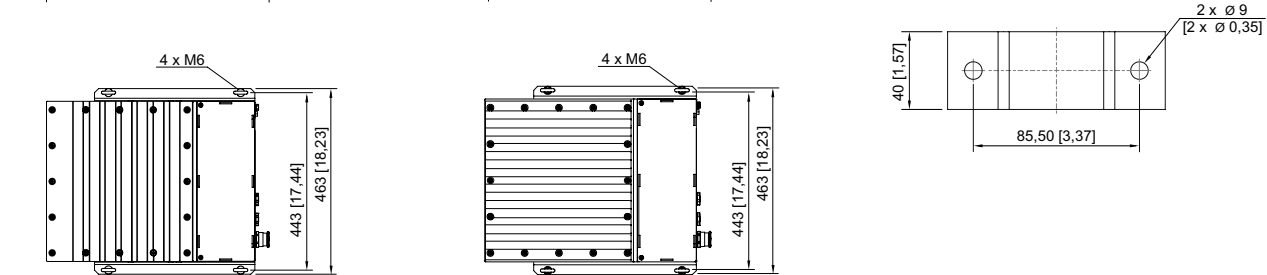
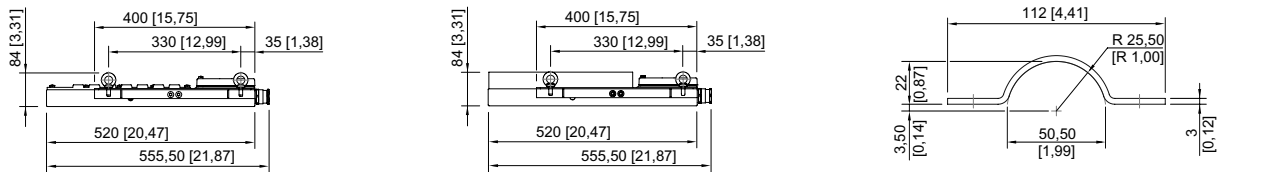
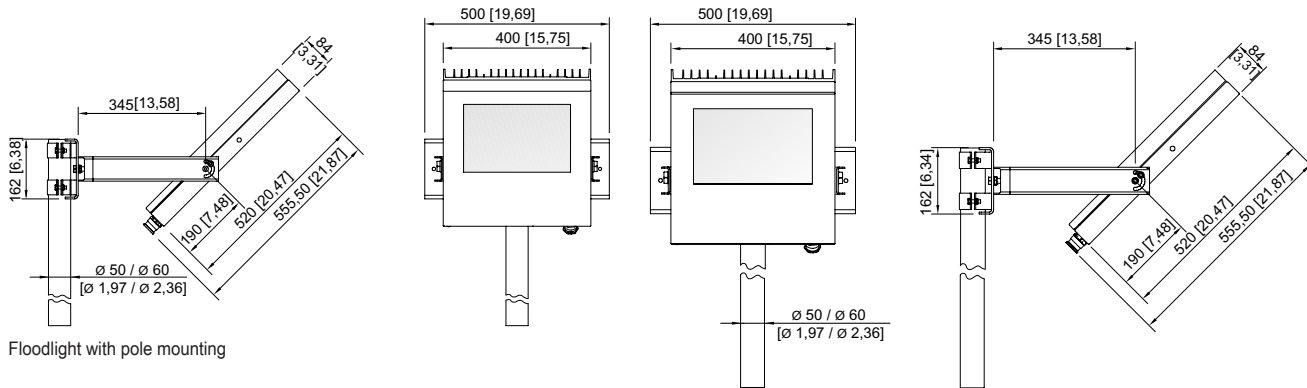

6125/2124-1501-6011-331 Art. No. 282392

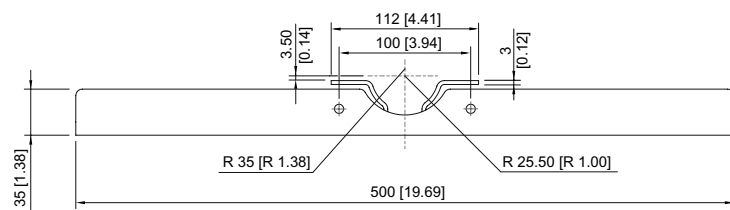
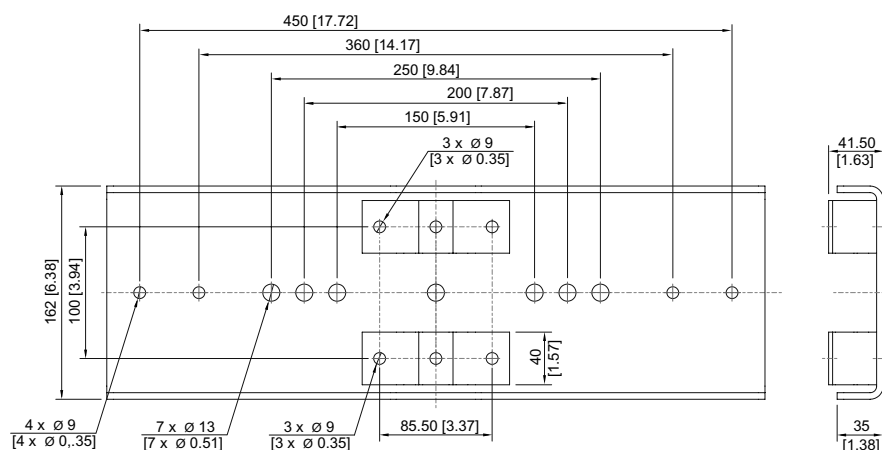
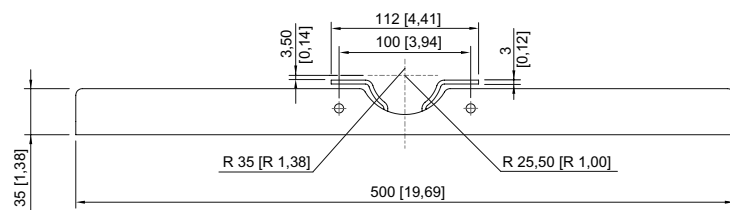
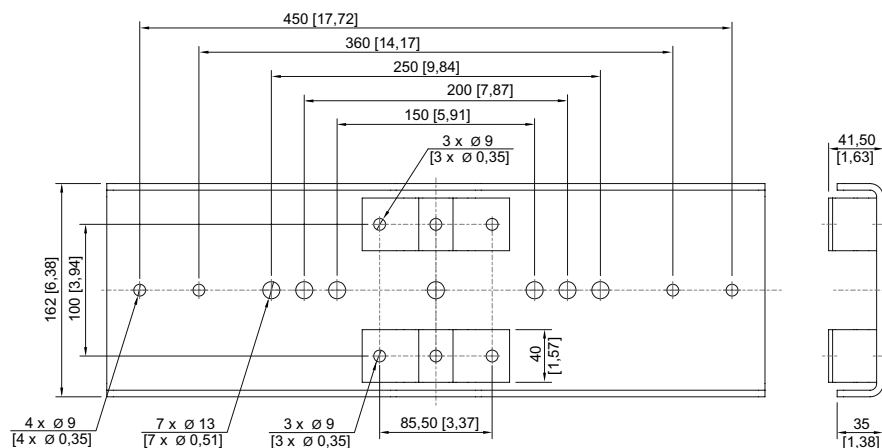

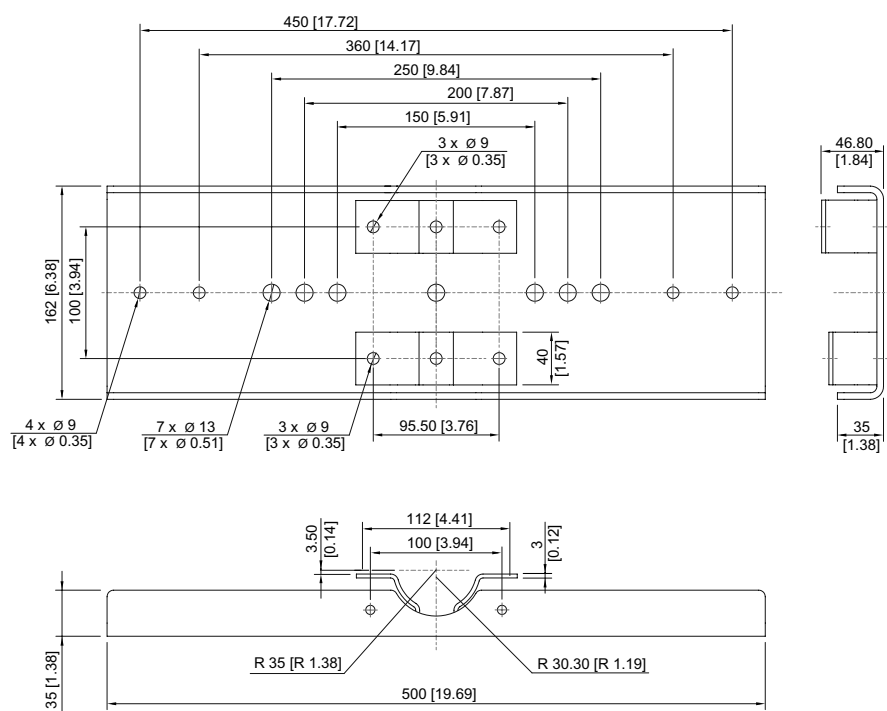
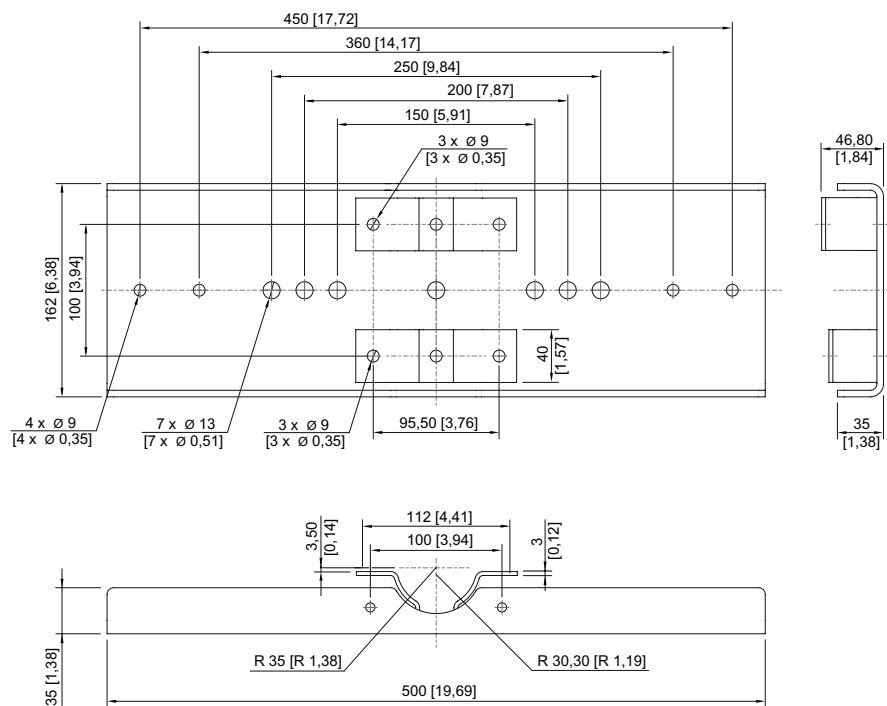

Accessories

Mounting set

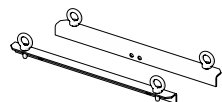

for pendant mounting with ring bolts included - stainless steel SS316L (1.4404 or V4A) without powder coating

Art. No.

257464

6125/2124-1501-6011-331 Art. No. 282392

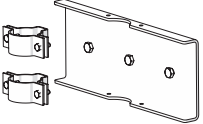
	for pole mounting with pole diameter of 50 mm - stainless steel SS316L (1.4404 or V4A) without powder coating	283361
	for pole mounting with pole diameter of 60 mm - stainless steel SS316L (1.4404 or V4A) without powder coating	263824

Ring bolt

Art. No.

	M6 (4 pieces), direct mounting in insert nuts	254234
--	---	--------

Mounting bracket

Art. No.

	Sheet steel, single powder coated	244604
	Stainless steel SS316L (1.4404 or V4A) without powder coating	221589

We reserve the right to make alterations to the technical data, dimensions, weights, designs and products available without notice. The illustrations cannot be considered binding.