

# Load disconnect switches and motor starters



## Load disconnect switch

80 A, non-fused

8146/5-V11-D07-00-0000-0 Art. No. 286763



- 3-pole horsepower (hp) rated switch
- Non-fused
- Suitable for voltages up to 600 V AC/240 V DC – limitations may apply
- Robust, lockable rotary actuator
- Lightweight construction
- Glass fibre reinforced polyester (GRP)
- Suitable for low ambient temperatures
- Enclosure type 3, 4, 4X, IP66
- No conduit seal required
- Quad certified

MY R. STAHL 8146V



Our switches are specifically engineered for hazardous locations and harsh environments with a corrosion resistant enclosure and wide temperature range. Ideal for close proximity installation of field equipment such as control panels, motors, skids or machinery. Whether the requirement is for disconnect switches to completely de-energize for service or maintenance tasks, or transfer switches to ensure continuous power supply to essential equipment, our solutions offer unmatched reliability. With our standard solutions, entries are not pre-installed, providing users with the flexibility to customized their own entries based on size, location and type. Built to withstand demanding conditions while ensuring safety and ease of use in various applications.

## Technical Data

### Explosion Protection

Area of application	European Union (ATEX) Canada IECEX USA
Application range (zones)	1, 2
IECEX gas certificate	IECEX PTB 06.0090
IECEX gas certificate	IECEX PTB 06.0090
IECEX gas explosion protection	Ex db eb IIC T5 Gb
IECEX dust certificate	IECEX PTB 06.0090
IECEX dust explosion protection	Ex tb IIIC T95 °C Db
ATEX gas certificate	PTB 01 ATEX 1024
ATEX gas certificate	PTB 01 ATEX 1024
ATEX gas explosion protection	⊕ II 2 G Ex db eb IIC T5 Gb
ATEX dust certificate	PTB 01 ATEX 1024
ATEX dust explosion protection	⊕ II 2 D Ex tb IIIC T95 °C Db
FMus certificate	FM18US0275X
cFM certificate	FM18CA0132X
Marking FMus	Class I, Div. 2, Groups A,B,C,D; Class II, III, Div. 1, Groups E,F,G, T5; Zone 1, AEx db eb IIC T5 Gb; Enclosure Type 3, 4, 4X
Marking cFM	Ex db eb IIC Gb; Class I, Div. 2, Groups A,B,C,D; Class II, III, Div. 1, Groups E,F,G, T5; Enclosure Type 3, 4, 4X

# Load disconnect switches and motor starters



## Load disconnect switch

80 A, non-fused

8146/5-V11-D07-00-0000-0 Art. No. 286763

### Explosion Protection

Marking cFM note	Zone 2 IIC according to Canadian Electrical Code Table 18
Certificates	ATEX (PTB), Canada (FM), IECEx (PTB), USA (FM)

### Electrical Data

Rated operational voltage AC	480 V
Rated operational voltage DC 1-pole	60 V
Rated operational voltage DC 2-pole	125 V
Rated operational voltage DC 3-pole	240 V
Rated operational current	80 A
Nominal power	60 hp
Nominal power note	Nominal power (hp) in relation to rated operating voltage 480 V AC
Auxiliary contact NC	without
Auxiliary contact NO	without
Short circuit protection (sym RMS)	20 kA
Additional short-circuit protection	Additional fuse necessary
Short-circuit protection note	Required back-up fuse in the electrical circuit
Frequency range	50 – 60 Hz

### Auxiliary Power

Nominal voltage	480 V AC
-----------------	----------

### Ambient Conditions

Ambient temperature	-50°C ... +55°C
Ambient temperature	-58°F ... +131°F

### Mechanical Data

Degree of protection (IP)	IP66
Enclosure type (UL50 & UL50E)	3, 4, 4X
Enclosure material	Polyester, Glass fibre reinforced
Additional terminal	without
Connection cross section, stranded min.	10 AWG
Connection cross section, stranded max.	1/0 AWG
Construction type	Standard
Width	340.5 mm
Width, inches	13.41 in
Height	340.5 mm
Height in inches	13.41 in
Depth	195 mm
Depth in inches	7.68 in
Service life, min.	10 <sup>5</sup> operating cycles
Handle colour	Black
Protective collar colour	Black
Seal	Silicone, foamed
Lockable in	Three times in 0 position
Detailed number of poles	3-pole
Weight	7.71 kg
Weight	17 lb

### Components

Entries	without
---------	---------

# Load disconnect switches and motor starters



## Load disconnect switch

80 A, non-fused

8146/5-V11-D07-00-0000-0 Art. No. 286763

### Technical Drawings – Subject to Alterations

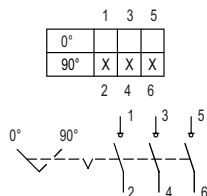

Switching arrangement 8544/1-3 and 8549/1-3

### Dimensional Drawings (All Dimensions in mm [inches]) – Subject to Alterations

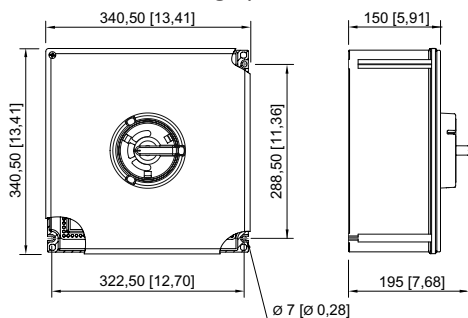

7146/5-V11-D06-00-0000-0  
7146/5-V11-D07-00-0000-0  
8146/5-V11-D06-00-0000-0  
8146/5-V11-D07-00-0000-0

## Accessories

Ex e cable glands for MC, MC-HL, combined and "TECK" armouring Series TMC

Art. No.

# Load disconnect switches and motor starters



## Load disconnect switch

80 A, non-fused

8146/5-V11-D07-00-0000-0 Art. No. 286763



Thread size: NPT1/2 Clamping range: 8.7 ... 12.7 mm Clamping range inch: 0.34 ... 0.5 in Nickel-plated brass	254316
Thread size: NPT1/2 Clamping range: 13 ... 17 mm Clamping range inch: 0.51 ... 0.67 in Nickel-plated brass	254317
Thread size: NPT3/4 Clamping range: 15 ... 23.3 mm Clamping range inch: 0.59 ... 0.92 in Nickel-plated brass	106090
Thread size: NPT1 Clamping range: 19.8 ... 29.2 mm Clamping range inch: 0.78 ... 1.15 in Nickel-plated brass	106091
Thread size: NPT1-1/4 Clamping range: 27.5 ... 35.2 mm Clamping range inch: 1.08 ... 1.39 in Nickel-plated brass	254320
Thread size: NPT1-1/2 Clamping range: 33.5 ... 41.1 mm Clamping range inch: 1.32 ... 1.62 in Nickel-plated brass	254321
Thread size: NPT2 Clamping range: 38.3 ... 47.1 mm Clamping range inch: 1.51 ... 1.85 in Nickel-plated brass	254322
Thread size: NPT2 Clamping range: 45 ... 53 mm Clamping range inch: 1.77 ... 2.09 in Nickel-plated brass	254323
Thread size: NPT2-1/2 Clamping range: 52.1 ... 58.9 mm Clamping range inch: 2.05 ... 2.32 in Nickel-plated brass	254324
Thread size: NPT2-1/2 Clamping range: 57.1 ... 64.6 mm Clamping range inch: 2.25 ... 2.54 in Nickel-plated brass	254325
Thread size: NPT3 Clamping range: 64.6 ... 75.3 mm Clamping range inch: 2.54 ... 2.96 in Nickel-plated brass	254326
Thread size: NPT3-1/2 Clamping range: 74 ... 88.5 mm Clamping range inch: 2.91 ... 3.48 in Nickel-plated brass	254327

# Load disconnect switches and motor starters



## Load disconnect switch

80 A, non-fused

8146/5-V11-D07-00-0000-0 Art. No. 286763

### Metal Ex e conduit hubs Series 8166

Art. No.

	Thread size: NPT1/2 Typ: 8166/11-01-NE	139082
	Thread size: NPT3/4 Typ: 8166/11-02-NE	139083
	Thread size: NPT1 Typ: 8166/11-03-NE	139084
	Thread size: NPT1-1/4 Typ: 8166/11-04-NE	139085
	Thread size: NPT1-1/2 Typ: 8166/11-05-NE	139086
	Thread size: NPT2 Typ: 8166/11-06-NE	139087
	Thread size: NPT2-1/2 Typ: 8166/11-07-NE	139088

### Auxiliary contact

Art. No.

	Note: The auxiliary contacts can only be retrofitted for 40 A, 63 A and 80 A versions. For all other versions, the auxiliary contact must be ordered separately when placing the order. Retrofitting is not possible for this.	
	2 NC (8080/1-3) 250 V AC/DC Max. 6 A 1.5 to 2.5 mm <sup>2</sup> , solid/finely stranded The switching function of the auxiliary contact depends on the installation slot used. Left and right: Synchronising	168356
	1 NC + 1 NO (8080/1-1) 250 V AC/DC Max. 6 A 1.5 to 2.5 mm <sup>2</sup> , solid/finely stranded The switching function of the auxiliary contact depends on the installation slot used. Left: Delayed (ON), leading (OFF) Right: Synchronising	168351
	2 NO (8080/1-4) 250 V AC/DC Max. 6 A 1.5 to 2.5 mm <sup>2</sup> , solid/finely stranded The switching function of the auxiliary contact depends on the installation slot used. Left and right: Synchronising	168353

### Spare Parts

#### Load/motor switch / Load disconnect switch

Art. No.

	60 A, 63 A and 80 A No. of poles: 3 P Type: 8544/1-32 Load/motor switch / Load disconnect switch	171154
--	---	--------

# Load disconnect switches and motor starters



Load disconnect switch

80 A, non-fused

8146/5-V11-D07-00-0000-0 Art. No. 286763

Auxiliary contact key		Art. No.
	For removing installed auxiliary contacts	201909

We reserve the right to make alterations to the technical data, dimensions, weights, designs and products available without notice. The illustrations cannot be considered binding.