

Signalling devices



Visual signalling device LED continuous beacon

In flameproof enclosure

FX15/B-P-060-G-EN-SF-A-ST-00-00-00 Art. No. 247029



- Lamp: Flashing beacon – XENON (5 J)/continuous beacon – LED (6.5 W)
- Type of protection: Ex d
- Class: IP66/IP67 (IEC 60529/NEMA 4X)
- Corrosion-resistant GRP enclosure
- Including stainless steel protective cage
- Eight light-amplifying Fresnel lens colours can be ordered
- Low weight (2.25 kg)

MY R. STAHL FX15A



The **FX15 product series** provides visual signals as a continuous beacon with LED or a 5 J flashing beacon with xenon flashes. The enclosure is made from glass fibre reinforced polyester. The product series is intended for use in hazardous and harsh environments.

Technical Data

Explosion Protection

Area of application	IECEX European Union (ATEX)
Application range (zones)	1, 2, 21, 22
IECEX gas certificate	IECEX BAS 13.0005X
IECEX gas explosion protection	Ex d IIB T6 Gb
IECEX dust certificate	IECEX BAS 13.0005X
IECEX dust explosion protection	Ex tb IIIC T85 °C Db
ATEX gas certificate	Baseefa 13 ATEX 0007X
ATEX gas explosion protection	⊕ II 2 G Ex d IIB T6 Gb
ATEX dust certificate	Baseefa 13 ATEX 0007X
ATEX dust explosion protection	⊕ II 2 D Ex tb IIIC T85 °C Db
Certificates	ATEX (BAS), IECEX (BAS)
Declaration of conformity	ATEX (EUK)

Electrical Data

Rated operational voltage AC	100 ... 254 V
Power	3.7 W
Tolerance	-10 ... 10 %

Lighting Data

Lamp	LED
Effective luminous intensity	51 cd
Luminous flux	45 lm

Ambient Conditions

Ambient temperature	-60 °C ... +70 °C (T6)
Operating temperature	-60 °C ... +50 °C

Mechanical Data

Degree of protection (IP)	IP66
Degree of protection (IP) (IEC 60529)	IP66/IP67

Signalling devices



Visual signalling device LED continuous beacon

In flameproof enclosure

FX15/B-P-060-G-EN-SF-A-ST-00-00-00 Art. No. 247029

Mechanical Data

Enclosure material	Polyester (GRP), Glass fibre reinforced
Enclosure colour	Black
Sealing material	Red silicone 70
Material dome	Polycarbonate, prismatic
Wire guard material	Stainless steel
Max. solid connection terminals	2.5 mm ²
Max. finely stranded connection terminals	2.5 mm ²
Type of connection cable	Solid Finely stranded
Width	137 mm
Height	239 mm
Length	148 mm
Lens colour	Green
Seal	O-ring seal
Weight	2.25 kg
Weight	4.96 lb

Mounting / Installation

Connection type	Screw terminal
Mounting part material	Stainless steel
Note about mounting	Can be ordered as accessories

Components

Drilled holes	3 x M20
Cable glands and entries	can be ordered as an accessory
Stopping plugs	3 x dust cap
Wire guard	Yes

Technical Drawings – Subject to Alterations

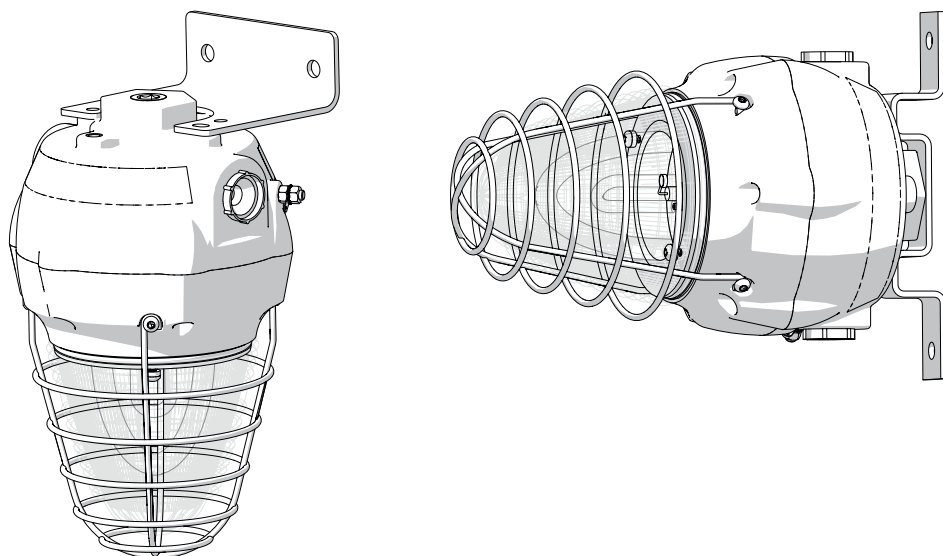

Signalling devices

Visual signalling device LED continuous beacon

In flameproof enclosure

FX15/B-P-060-G-EN-SF-A-ST-00-00-00 Art. No. 247029



Dimensional Drawings (All Dimensions in mm [inches]) – Subject to Alterations

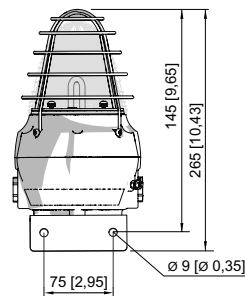
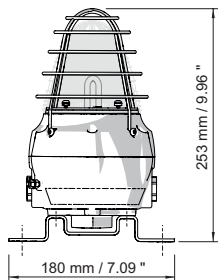
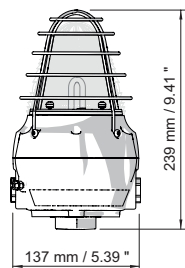
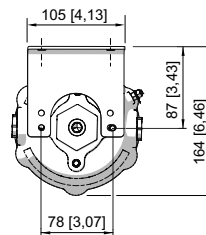
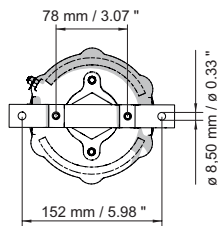
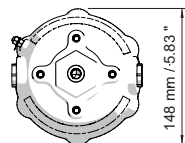

FX15 flashing beacon

FX15 flashing beacon with fastening bracket

FX15 flashing beacon with L-bracket

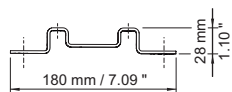
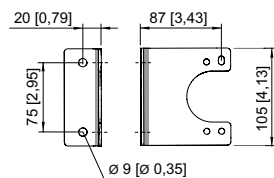
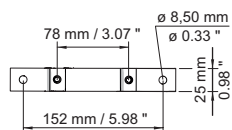

L-bracket

Fastening bracket

Accessories

Metal cable gland

Art. No.

	<p>Ex d and Ex e cable gland with compound for all types of armoured cables (SWA, wire-braid, tape) (nickel-plated brass) Type 20PX2K, M20 x 1.5</p>	<p>109428</p>
	<p>Ex d and Ex e cable glands with RapidEx sealing system for all types of unarmoured cables and wire-braid-armoured cables (nickel-plated brass) Type 20PX2K-REX, M20 x 1.5</p>	<p>246649</p>
	<p>Ex d and Ex e cable glands with compound for all types of unarmoured cables and wire-braid-armoured cables (nickel-plated brass) Type 20PXSS2K, M20 x 1.5</p>	<p>109441</p>
	<p>Ex d and Ex e cable glands with RapidEx sealing system for all types of unarmoured cables and wire-braid-armoured cables (nickel-plated brass) Type 20PXSS2K-REX, M20 x 1.5</p>	<p>246605</p>
	<p>Ex d and Ex e cable gland for all types of unarmoured cables (SWA, wire-braid, tape) (nickel-plated brass) with a special compensating sliding seal (CDS) Type 20T3CDS, M20 x 1.5</p>	<p>246561</p>

Signalling devices



Visual signalling device LED continuous beacon

In flameproof enclosure

FX15/B-P-060-G-EN-SF-A-ST-00-00-00 Art. No. 247029



Stopping plug

Art. No.

	Stainless steel stopping plug M20x1.5 with hexagon insert bit	251101
--	---	--------

Mounting accessories

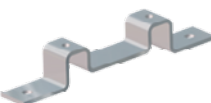
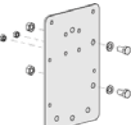
Art. No.

	Stainless steel L-bracket, standard version	221711
	Stainless steel L-bracket, long version	247371
	Stainless steel fastening bracket	221712
	Adapter plate for pipe clamp fastening	256519
	Stainless steel sun shield	262077
	Pipe clamp, R 1 1/4"	120812
	Pipe clamp, R 1 1/2"	120819
	Pipe clamp, R 2"	120823

Spare Parts

Flange

Art. No.

	Flange, ATEX, green (available for FL6S, FX15, YL6S)	243405
--	--	--------

Fresnel lens

Art. No.

	Fresnel lens, green, spare	292143
--	----------------------------	--------

We reserve the right to make alterations to the technical data, dimensions, weights, designs and products available without notice. The illustrations cannot be considered binding.