

Lighting

Compact light fitting Emergency luminaire

With ILS

6102/111-0130-150-0111-31-1850-D1 Art. No. 287793



- Suitable for wall, ceiling and suspended mounting
- With either DALI or address module
- Emergency exit signs with suspended panel so that they can be read from both sides
- Large recognition range $d \geq 30$ m
- Lightweight, robust and compact design

MY R. STAHL 6102A



The Series C-LUX 6102 compact light fittings can be used for normal lighting or as emergency luminaires in conjunction with emergency exit signs and/or an address module for use in central battery systems.

Technical Data

Explosion Protection

| | |
|---------------------------------|---|
| Area of application | European Union (ATEX) IECEX |
| Ex version | Yes |
| Application range (zones) | 1, 2, 21, 22 |
| IECEX gas certificate | IECEX IBE 19.0016 |
| IECEX gas explosion protection | Ex db eb ib op is IIC T4 Gb |
| IECEX dust certificate | IECEX IBE 19.0016 |
| IECEX dust explosion protection | Ex tb op is IIIC T100 °C Db |
| ATEX gas certificate | IBExU 19 ATEX 1072 |
| ATEX gas explosion protection | Ⓔ II 2 G Ex db eb ib op is IIC T4 Gb |
| ATEX dust certificate | IBExU 19 ATEX 1072 |
| ATEX dust explosion protection | Ⓔ II 2 D Ex tb op is IIIC T100 °C Db |
| Certificates and approvals | ATEX IECEX UKEX |
| Certificates | ATEX (IBE), Brazil (ULB), China (NEPSI), IECEX (IBE), Polen (CNBOP) |
| Ship approval | DNVGL |
| Declaration of Conformity | ATEX (EUK), Declaration of Conformity (AUS) |

Electrical Data

| | |
|----------------------|-------------------------|
| Frequency range | 50 Hz |
| AC operating voltage | 220 to 240 V |
| DC operating voltage | 194 to 250 V |
| Control interface | Internal address module |

Lighting Data

| | |
|--------------------|--------|
| Lamp | LED |
| Luminaire efficacy | 0 lm/W |
| Luminous flux | 0 lm |

Lighting

Compact light fitting Emergency luminaire

With ILS

6102/111-0130-150-0111-31-1850-D1 Art. No. 287793



Ambient Conditions

| | |
|---------------------|--|
| Ambient temperature | -30 °C ... +50 °C Note: Through wiring Max. 3x16 A -30 °C ... +60 °C Note: Through wiring 2 Max. 3x10 A |
|---------------------|--|

Mechanical Data

| | |
|---|------------------------------------|
| IP degree of protection (IEC 60598) | IP66 / IP67 |
| Class | I |
| Enclosure material | Thermoset |
| Enclosure colour | Light grey (RAL 7035) |
| Cover material | Polycarbonate |
| Sealing material | Silicone |
| Silicone-free content | Without influence on paint wetting |
| Pane material | PMMA |
| Installed terminal strip | PE + N- + L+ + L" + N" |
| Max. solid connection terminals | 6 mm ² |
| Max. finely stranded connection terminals | 4 mm ² |
| Type of connection cable | Finely stranded Solid |
| Size | 1 |
| Width | 185 mm |
| Height | 240 mm |
| Length | 440 mm |
| Impact strength (IEC 62262) | IK08 |
| Weight | 3.57 kg |
| Weight | 7.87 lb |
| Disconnection of the luminaire | No |

Components

| | |
|--------------------------|--------------------------------------|
| Variant | Escape route downstairs Single-sided |
| Threaded plate | Plastic |
| Ballast | 6045/312-842-20 AC/DC int. ADR |
| Through wiring | Loop in/loop out |
| Drilled holes | 3 x M25 |
| Cable glands and entries | 2 x M25 Ø 7 ... |
| Stopping plugs | 2 x M25 x 1.5 |
| Stopping plug material | Polyamide, black |
| Breather | without |
| Accessories | Provided |

Light Distribution Curves

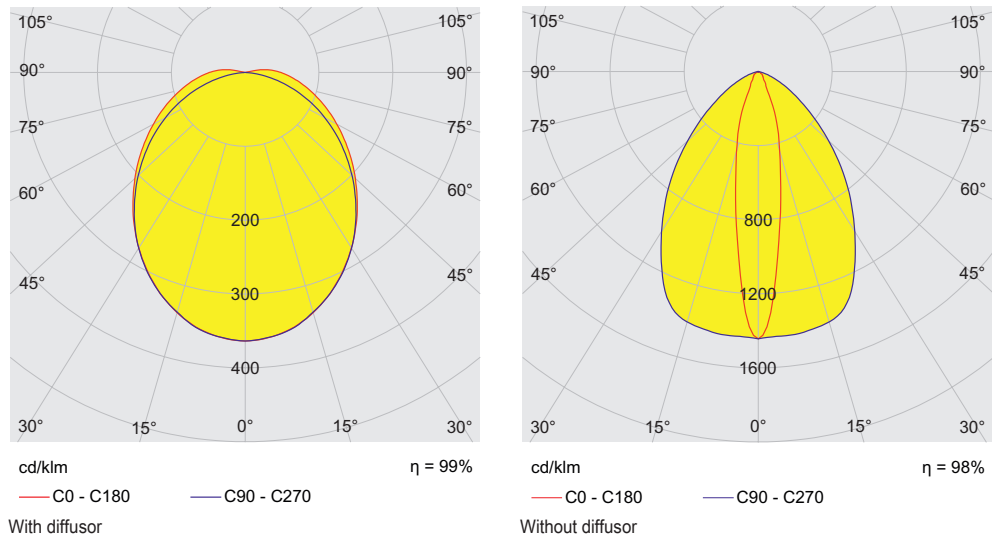

Dimensional Drawings (All Dimensions in mm [inches]) – Subject to Alterations

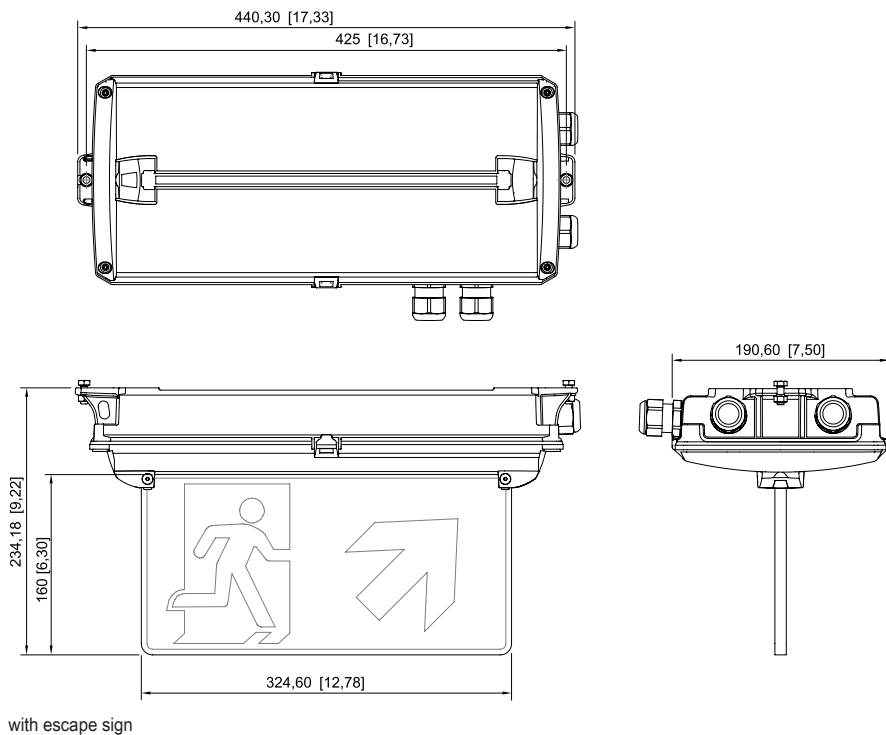

Lighting

Compact light fitting Emergency luminaire

With ILS

6102/111-0130-150-0111-31-1850-D1 Art. No. 287793

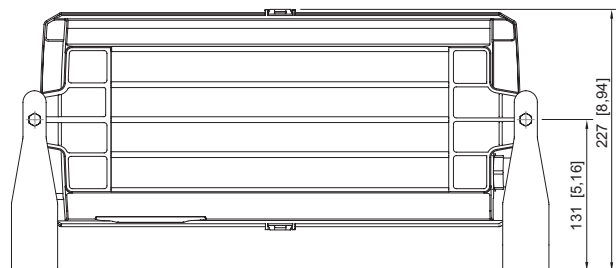
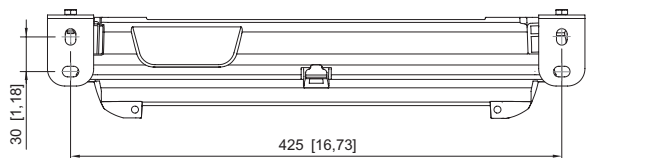

with mounting brackets

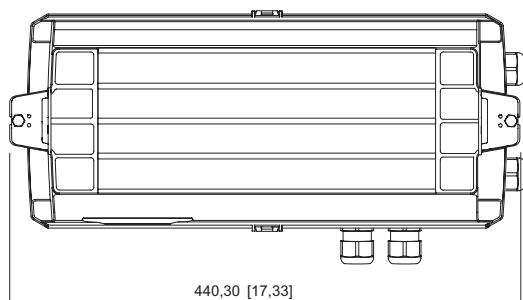
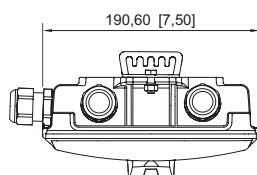
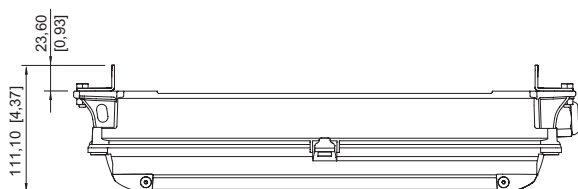

for rope/chain mounting

Accessories

Fastening set

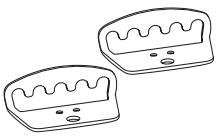
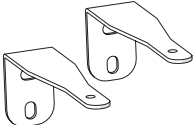
| | | Art. No. |
|--|-------------------------|----------|
|  | for chain/rope assembly | 275407 |
|  | for wall mounting | 275408 |

Light panel

| | | Art. No. |
|--|---------------------------|----------|
|  | Escape route double sided | 275872 |







Lighting

Compact light fitting Emergency luminaire

With ILS

6102/111-0130-150-0111-31-1850-D1 Art. No. 287793



| | | |
|--|--|--------|
|  | Escape route, down | 274776 |
|  | Escape route, up | 274758 |
|  | Escape route, down double-sided | 274780 |
|  | Escape route, left | 274757 |
|  | Escape route, right | 274775 |
|  | Escape route left/right double-sided | 274773 |
|  | Escape route stairs, down left | 274777 |
|  | Escape route stairs, down right | 274778 |
|  | Escape route stairs, down double-sided | 274779 |
|  | Escape route stairs, up left | 274759 |
|  | Escape route stairs, up right | 274760 |
|  | Escape route stairs, up double-sided | 274771 |
|  | Escape route, up double-sided | 274772 |

Lighting

Compact light fitting Emergency luminaire



With ILS

6102/111-0130-150-0111-31-1850-D1 Art. No. 287793



| | | |
|--|------|--------|
|  | EXIT | 275514 |
|--|------|--------|

Spare Parts

| Optic | | Art. No. |
|--|-------------------|----------|
|  | Diffuser | 274756 |
|  | Deflection optics | 274781 |

We reserve the right to make alterations to the technical data, dimensions, weights, designs and products available without notice. The illustrations cannot be considered binding.