

Control and signalling devices

Control device system Series ConSig 8040

STAHL

ConSig

8040/1380X-01L13SA05-01L08SA05-01L15SA05 Art. No. 130861



- Flexible: Modular design and three sizes make customer-specific versions possible
- Lightweight enclosure made of glass fibre reinforced polyester resin (GRP), suitable for the marine industry and offshore applications

MY R. STAHL 8040B

With the R. STAHL Series 8040 control device system, you can get a clear overview of the control devices. The three combinable sizes and the modular design offer flexibility. You can choose from one standard version and customised variants.

Technical Data

Explosion Protection	
Area of application	IECEX European Union (ATEX)
Application range (zones)	1, 2, 21, 22
IECEX gas certificate	IECEX PTB 06.0025
IECEX gas certificate	PTB 01 ATEX 1105
IECEX gas explosion protection	Ex db eb IIC T6 / T5 Gb
IECEX dust certificate	IECEX PTB 06.0025
IECEX dust explosion protection	Ex tb IIIC T80 °C / T95 °C Db
ATEX gas certificate	PTB 01 ATEX 1105
ATEX gas certificate	PTB 01 ATEX 1105
ATEX gas explosion protection	Ex II 2 G Ex db eb IIC T6 / T5 Gb
ATEX dust certificate	PTB 01 ATEX 1105
ATEX dust explosion protection	Ex II 2 D Ex tb IIIC T80 °C / T95 °C Db
Certificates	ATEX (PTB), Brazil (ULB), Canada (UL), China (NEPSI), IECEX (PTB), India (PESO), Korea (KGS), Taiwan (ITRI), USA (UL)
Ship approval	DNVGL
Declaration of conformity	ATEX (EUK), China (CCC)
Explosion protection note	Product label may vary. Series devices are labelled with ATEX and IECEX.
Electrical Data	
Rated operational voltage AC	550 V
Rated operational current	10 A (T6)
Ambient Conditions	
Ambient temperature	-60 °C ... 40 °C (T6) -60 °C ... 55 °C (T5)
Ambient temperature	-76 °F ... 104 ... +104 °F (T6) -76 °F ... +131 °F (T5)
Mechanical Data	
IP degree of protection (IEC 60529)	IP66

Control and signalling devices

Control device system Series ConSig 8040



8040/1380X-01L13SA05-01L08SA05-01L15SA05 Art. No. 130861

Mechanical Data

Enclosure material	Polyester resin, Glass fibre reinforced
Enclosure colour	Dark grey
Silicone-free	No
Clamping range AWG	14 AWG
Connection cross-section max.	2.5 mm ²
Solid connection cross section	0.32 – 2.5 mm ²
Connection cross-section AWG single stranded	22 AWG ... 14 AWG
Finely stranded connection cross section	0.32 – 2.5 mm ²
Finely stranded connection cross-section AWG	22 AWG ... 14 AWG
Cover fixing type	With captive screws, M4 stainless steel screws
Width	80 mm
Width, inches	3.15 in
Height	185 mm
Height in inches	7.28 in
Depth	72 mm
Depth in inches	2.76 in
Seal	Silicone, foamed
Weight	580 g
Weight	1.28 lb

Mounting / Installation

Tightening torque of cover screw 1	1.4 Nm
Tightening torque of cover screw 1 lbf in	12.4 lbf in

Components

Installation position top	Pushbutton, Green - "I"
Built-in element top	Contact element NC/NO
Installation position middle	Pushbutton, Red - "0"
Built-in element middle	Contact element NC/NO
Installation position bottom	Pushbutton, Green - "II"
Built-in element bottom	Contact element NC/NO
Flange and plates	Without flange, without plates
Cable glands and entries	1 x M25 Ø 7 ... 17 mm
Entry type	Standard 8161, moulded material
Entry 1	1 x 8161/7-M25-1707-LT
Entry 1 type	Polyamide cable gland, black
Entry 1	M25 x 1.5
Entry 1 clamping range	7 – 17 mm
Entry 1 clamping range, inch	0.28 – 0.67 in
Metal entry possible 1	No

Technical Drawings – Subject to Alterations

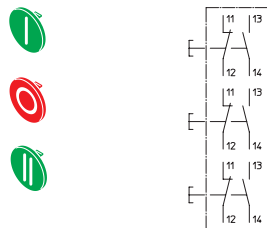

Dimensional Drawings (All Dimensions in mm [inches]) – Subject to Alterations

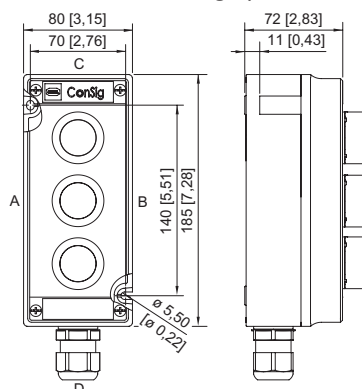

ConSig 8040/13

Accessories

Pushbutton BG001



Ø 39 mm
Black
Designation plate: Black, blank disc without text
Front panel mounting
Silicone-free: No

Art. No.

223692

Spare Parts

Designation plates set for BG001, BG023



The button label set contains nine labels
6x blank disc without text in red, green, white, blue, yellow and black
1x red label, text: STOP
1x green label, text: START
1x blue label, text: RESET

Art. No.

321791

Label holder



Size 1, without insert disc, 1-line label
for actuators Ø 39

Art. No.

223566



Size 2, without insert disc, 1- or 2-line label
for actuators Ø 39

Art. No.

223567

Control and signalling devices

Control device system Series ConSig 8040





8040/1380X-01L13SA05-01L08SA05-01L15SA05 Art. No. 130861

	Size 3, without insert disc, 1-, 2- or 3-line label for actuators Ø 39	223568
--	--	--------

Locking devices

Art. No.

	8602C3-753 for not actuated pushbutton BG001	244870
	8602C3-754 for actuated pushbutton BG001	244871
	8602C3-755 for not actuated pushbutton BG001	244872

Special key

Art. No.

	for tightening plastic locking nut	169101
--	------------------------------------	--------

Tag label

Art. No.

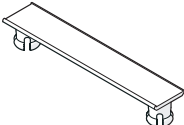
	plain for attaching to enclosure 8040; moulded material; with paper insert strip	130673
--	--	--------

We reserve the right to make alterations to the technical data, dimensions, weights, designs and products available without notice. The illustrations cannot be considered binding.