



- Flexible: Modular design and three sizes make customer-specific versions possible
- Lightweight enclosure made of glass fibre reinforced polyester resin (GRP), suitable for the marine industry and offshore applications

MY R. STAHL 8040B



With the R. STAHL Series 8040 control device system, you can get a clear overview of the control devices. The three combinable sizes and the modular design offer flexibility. You can choose from one standard version and customised variants.

Technical Data

Explosion Protection	
Area of application	IECEX
Application range (zones)	1, 2, 21, 22
IECEX gas certificate	IECEX PTB 06.0025
IECEX gas certificate	IECEX PTB 06.0025
IECEX gas explosion protection	Ex db eb IIC T6 Gb
IECEX dust certificate	IECEX PTB 06.0025
IECEX dust explosion protection	Ex tb IIIC T80 °C Db
ATEX gas certificate	PTB 01 ATEX 1105
ATEX gas certificate	PTB 01 ATEX 1105
ATEX gas explosion protection	Ex II 2 G Ex db eb IIC T6 Gb
ATEX dust certificate	PTB 01 ATEX 1105
ATEX dust explosion protection	Ex II 2 D Ex tb IIIC T80 °C Db
Certificates	ATEX (PTB), Brazil (ULB), Canada (UL), China (NEPSI), IECEX (PTB), India (PESO), Korea (KGS), Taiwan (ITRI), USA (UL)
Ship approval	DNVGL
Declaration of conformity	ATEX (EUK), China (CCC)
Explosion protection note	Product label may vary. Series devices are labelled with ATEX and IECEX.
Electrical Data	
Rated operational voltage AC	550 V
Rated operational current	10 A (T6)
Ambient Conditions	
Ambient temperature	-60 °C ... 60 °C (T6)
Ambient temperature	-76 °F ... 140 (T6)
Mechanical Data	
IP degree of protection (IEC 60529)	IP66
Enclosure material	Polyester resin, Glass fibre reinforced
Enclosure colour	Dark grey
Silicone-free	No

Control and signalling devices

Control device system Series ConSig 8040



8040/1280X-01L13SA02-01L08SA01 Art. No. 130899

Mechanical Data

Connection cross-section max.	2.5 mm ²
Solid connection cross section	0.32 – 2.5 mm ²
Connection cross-section AWG single stranded	22 AWG ... 14 AWG
Finely stranded connection cross section	0.32 – 2.5 mm ²
Finely stranded connection cross-section AWG	22 AWG ... 14 AWG
Cover fixing type	With captive screws, M4 stainless steel screws
Width	80 mm
Width, inches	3.15 in
Height	139 mm
Height in inches	5.47 in
Depth	72 mm
Depth in inches	2.76 in
Seal	Silicone, foamed
Weight	500 g
Weight	1.1 lb

Mounting / Installation

Tightening torque of cover screw 1	1.4 N · m
Tightening torque of cover screw 1 lbf in	12.4 lbf in

Components

Installation position top	Pushbutton, Green - "I"
Built-in element top	Contact element NO
Installation position bottom	Pushbutton, red – "0"
Built-in element bottom	Contact element NC
Flange and plates	Without flange, without plates
Cable glands and entries	1 x M25 Ø 7 ... 17 mm
Entry type	Standard 8161, moulded material
Entry 1	1 x 8161/7-M25-1707-LT
Entry 1 type	Polyamide cable gland, black
Entry 1	M25 x 1.5
Entry 1 clamping range	7 – 17 mm
Entry 1 clamping range, inch	0.28 – 0.67 in
Metal entry possible 1	No

Dimensional Drawings (All Dimensions in mm [inches]) – Subject to Alterations

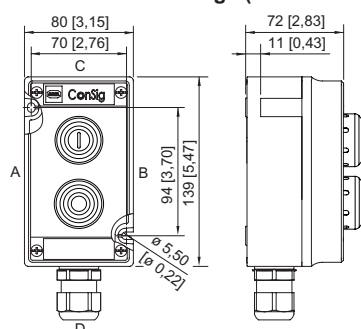

ConSig 8040/12

Control and signalling devices



Control device system Series ConSig 8040



8040/1280X-01L13SA02-01L08SA01 Art. No. 130899

Accessories

Locking devices



		Art. No.
	8602C3-753 for not actuated pushbutton BG001	244870
	8602C3-754 for actuated pushbutton BG001	244871
	8602C3-755 for not actuated pushbutton BG001	244872

Pushbutton BG001

		Art. No.
	Ø 39 mm Black Designation plate: Black, blank disc without text Front panel mounting Silicone-free: No	223692

Spare Parts

Label holder

		Art. No.
	Size 1, without insert disc, 1-line label for actuators Ø 39	223566
	Size 2, without insert disc, 1- or 2-line label for actuators Ø 39	223567
	Size 3, without insert disc, 1-, 2- or 3-line label for actuators Ø 39	223568

Special key

		Art. No.
	for tightening plastic locking nut	169101

Tag label

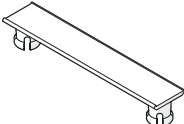
		Art. No.
	plain for attaching to enclosure 8040; moulded material; with paper insert strip	130673

Control and signalling devices

Control device system Series ConSig 8040



8040/1280X-01L13SA02-01L08SA01 Art. No. 130899

We reserve the right to make alterations to the technical data, dimensions, weights, designs and products available without notice. The illustrations cannot be considered binding.