

8070/1-3-ZB Art. No. 131969



- Interchangeable Ex d contact element
- Various actuators possible, all of which can be repositioned by 4 x 90°
- Suitable for safety circuits in accordance with IEC/EN 60947-5-1, category 2 safety position switch thanks to separate actuator

WebCode **8070B**



R. STAHL's 8070 series safety position switches are suitable for switching control and signal circuits and for safety circuits in accordance with EN 60947-5-1 in "increased safety" enclosures. The dimensions comply with EN 50047. They are able to switch different potentials, comprise an interchangeable Ex d contact element with positive-opening contacts, and are available with a variety of actuators.

### Technical Data

#### Explosion Protection

Scope of validity	IECEX
Application range (zones)	1 2 21 22
IECEX gas certificate	IECEX PTB 06.0092
IECEX gas explosion protection	Ex de IIC T6
IECEX dust certificate	IECEX PTB 06.0092
IECEX dust explosion protection	Ex tD A21 T80 °C
ATEX gas certificate	PTB 01 ATEX 1053
ATEX gas explosion protection	⊕ II 2 G Ex de IIC T6
ATEX dust certificate	PTB 01 ATEX 1053
ATEX dust explosion protection	⊕ II 2 D Ex tD A21 T80 °C

#### Electrical Data

DC rated operational voltage	250 V
AC operating voltage (equal potential)	400 V
AC operating voltage (unequal potential)	250 V
Actuating time	0
Rated surge voltage	0 kV
Short-circuit protection, max.	10 A
Tripping characteristic	gG

#### Ambient Conditions

Ambient temperature	-20 °C ... +50 °C
---------------------	-------------------

#### Mechanical Data

Degree of protection (IP)	IP65
Enclosure material	Polyamide, Glass fibre reinforced

8070/1-3-ZB Art. No. 131969

### Mechanical Data

Max. earth connection	0 mm <sup>2</sup>
Contact material	Silver-nickel
Number of NCs	2
Number of NOs	0
Actuator	Safety switch
Clamping range	4 ... 13 mm
Contacts	2 NC
Enclosure colour	Black
Packaging unit	1
Weight	0.208 kg
Weight	0.46 lb

### Components

Actuator 2	With separate actuator
Cable glands and entries	1 x M20 x 1.5

### Technical Drawings – Subject to Alterations

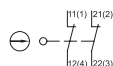
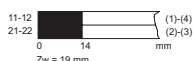

Diagram with positive opening 8060/1-3-..; 8070/1-3-..



Nominal contact travels or angles:

■ = Contact closed

□ = Contact open

Zw = Travel for positive opening

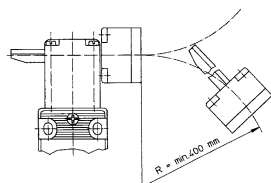
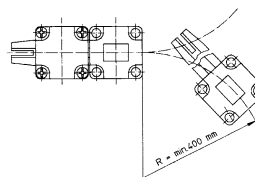

Do not use the switch as a mechanical stop.

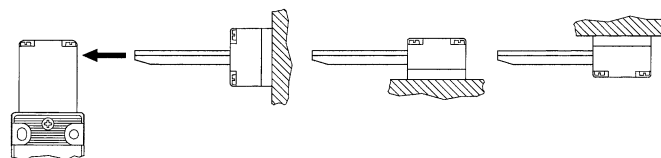

The actuators can be mounted in several ways, this substantially increases the range of application of the switches.

### Dimensional Drawings (All Dimensions in mm [inches]) – Subject to Alterations

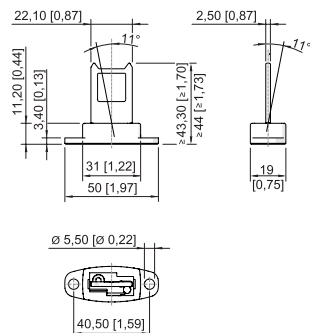

Adjustable actuator for safety switch

## Accessories

Actuator

Art. No.

8070/1-3-ZB Art. No. 131969

	Safety switch with separate actuator (safety operating head) 8070/1-0-ZB	131832
--	--	--------

**Cable gland made of plastic**

	8161/7-M20-1304, Ex e Plastic, M20 x 1.5, cable outer diameter 4 to 13 mm Lot size 50 pieces	<b>Art. No.</b> 239156
--	--	---------------------------

**Spare Parts**

<b>Actuator</b>		<b>Art. No.</b>
	Safety switch with separate actuator (safety operating head) 8070/1-0-ZB	131835

We reserve the right to make alterations to the technical data, dimensions, weights, designs and products available without notice. The illustrations cannot be considered binding.