

8265/06-0000 Art. No. 143413



- Six basic enclosure sizes, optional inspection windows, direct and indirect cable entry possible
- International certification, wide temperature range, seawater-resistant light-metal enclosure
- Suitable series 8146/8150 connection-chamber enclosures possible

MY R. STAHL 8265A



R. STAHL series 8265 Ex d enclosures are ideal for motor control units, control boxes and terminal boxes. We equip these with various components, including sparking equipment, according to customer requirements. The cable entry can be direct or indirect. The large cover opening makes commissioning and maintenance easier. Single enclosures are ideal as components in Ex e control systems. Optional, large inspection window possible.

Technical Data

Explosion Protection

Application range (zones)	1, 2, 21, 22
IECEX gas certificate	IECEX PTB 07.0027 U
IECEX gas explosion protection	Ex db eb IIC Gb
IECEX dust certificate	IECEX PTB 07.0027 U
IECEX dust explosion protection	Ex tb IIIC Db
ATEX gas certificate	PTB 06 ATEX 1023 U
ATEX gas explosion protection	Ex II 2 G Ex db eb IIC Gb
ATEX dust certificate	PTB 06 ATEX 1023 U
ATEX dust explosion protection	Ex II 2 D Ex tb IIIC Db
Certificates	ATEX (PTB), Brazil (ULB), China (NEPSI), IECEX (PTB), Taiwan (ITRI)
Ship approval	DNV
Declaration of Conformity	Certificate of conformity (ATEX), China (CCC)

Ambient Conditions

Ambient temperature	-50 °C ... +60 °C
Ambient temperature	-58°F ... +140°F

Mechanical Data

Degree of protection (IP)	IP54
Note on degree of protection	IP66 with O-ring silicone -60 °C ... +60 °C
Enclosure material	Aluminium, copper-free, Seawater-resistant
Enclosure colour	without
Material note	Where there will be direct contact with seawater, a coating is recommended.
Clamping range max.	120 mm ²
Cover	Closed
Design	Without entry
Width	335 mm
Width, inches	13.19 in

8265/06-0000 Art. No. 143413

Mechanical Data

Height	281 mm
Height in inches	11.06 in
Length	335 mm
Length in inches	13.19 in
Diameter	410 mm
Enclosure size	6
Weight	27.8 kg
Weight	61.29 lb

Dimensional Drawings (All Dimensions in mm [inches]) – Subject to Alterations

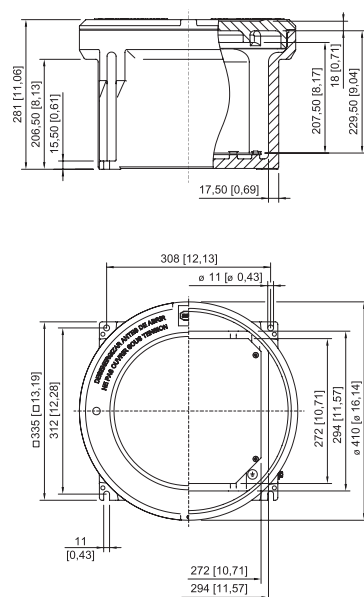

Size 6 enclosure without sight glass

Accessories

Cover without sight glass

		Art. No.
	Enclosure: 8265/.6-0000	143476

Mounting rail

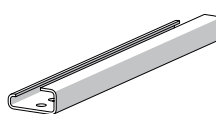
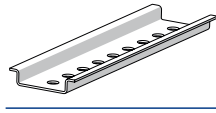
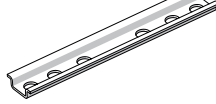
		Art. No.
	G32 length: 280 mm [11.02 inch] for size 6 enclosure	166450
	TS35 length: 280 mm [11.02 inch] for size 6 enclosure	166449
	TS15 length: 280 mm [11.02 inch] for size 6 enclosure	166448

8265/06-0000 Art. No. 143413

Threaded pin

Art. No.

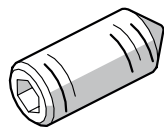

M5x16-A2 with hexagon socket and pointed tip

110216

Spare Parts

Mounting plate

Art. No.



for size 6 enclosure
M5 x 8 screws are not included in the delivery

143488

O-ring

Art. No.

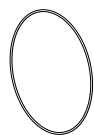

Silicone, for size 6 enclosure

305633

We reserve the right to make alterations to the technical data, dimensions, weights, designs and products available without notice. The illustrations cannot be considered binding.