

# Signalling devices



Audible signalling device Sounder

In flameproof enclosure

YA90/C-D-UL-RN-ST-00-00-00 Art. No. 205365



- Horn: Directional/max. 115 dB(A)
- Type of protection: Ex d
- Class: IP66 (IEC 60529)
- Corrosion-resistant GRP enclosure
- Including fastening bracket
- 32 standardised preconfigured signal tones (compatible with PFEER/UKOOA)
- Two separate signal tones can be selected
- Connection for telephone systems can be ordered as an option
- Optional line monitoring

MY R. STAHL YA90A



The YA90 product series provides directional, audible signals and is intended for use in hazardous or extremely harsh environments.

## Technical Data

### Explosion Protection

Area of application	European Union (ATEX) Canada IECEX USA
Application range (zones)	1, 2, 21, 22
Certificate ULus	UL E161818
USA dust certificate	UL E161818
Marking cULus	Class I, Div. 2, Groups A,B,C,D
Certificate cUL	UL E161818
CAN dust certificate	UL E161818
Marking cULus	Class I, Div. 2, Groups A,B,C,D
Certificates	Canada / USA (UL), IECEX (BAS)

### Electrical Data

Rated operational voltage DC	24 V
Rated operational current	0.5 A (T4)
Tolerance	-10 ... 10 %

### Acoustic Data

Sound pressure level	max. 115 dB(A) @ 1 m
Sound pressure level, inches	Max. 110 dB(A) @ 39.37"
Tone selection	Via DIL switch
Sound level	2

# Signalling devices

Audible signalling device Sounder

In flameproof enclosure

YA90/C-D-UL-RN-ST-00-00-00 Art. No. 205365



Polar diagram

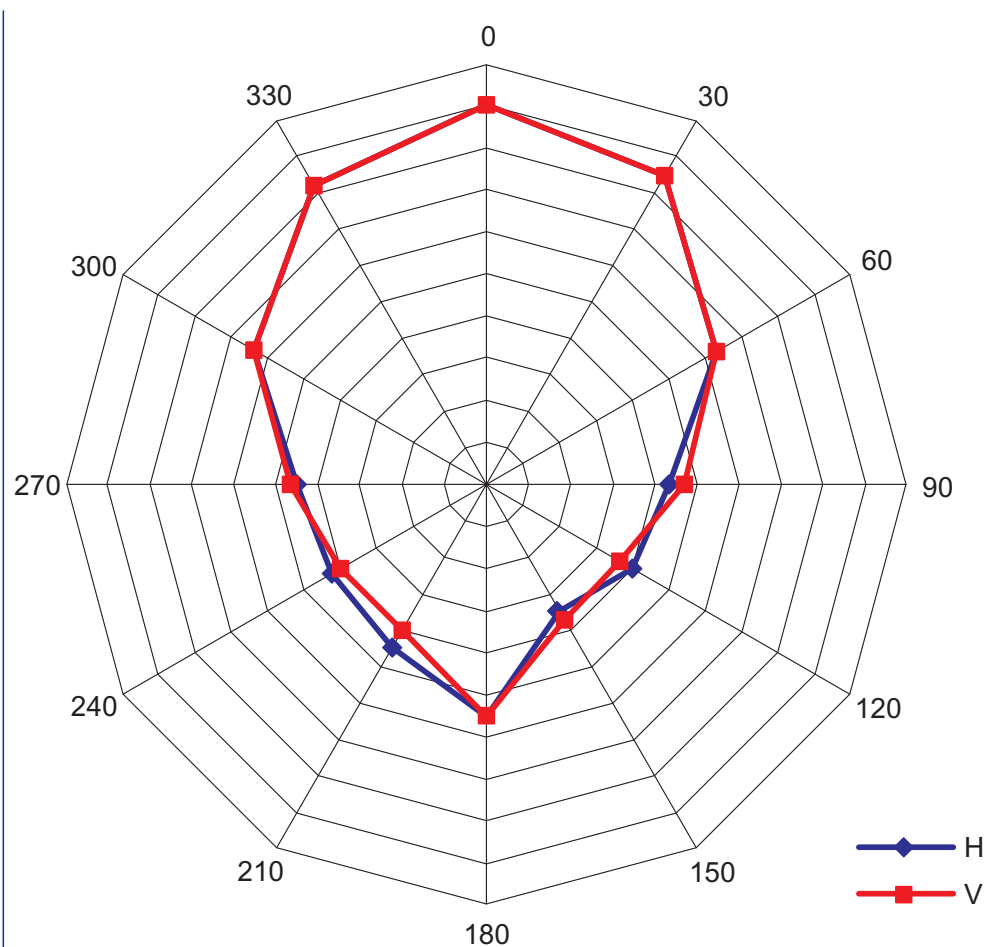

## Ambient Conditions

Ambient temperature -60 °C ... +66 °C

Ambient temperature -76°F ... +151°F

## Mechanical Data

Degree of protection (IP) (IEC 60529) IP66

Enclosure material Polyester (GRP), Glass fibre reinforced

Enclosure colour Red (RAL 3001)

Trumpet material ABS, flame retardant

Connection terminal, solid, max. AWG AWG 14

Connection terminal, finely stranded, max. AWG AWG 14

Cable length, inches 0 in

Width 325 mm

Width, inches 12.8 in

Height 210 mm

Height in inches 8.27 in

Length 210 mm

Length in inches 8.27 in

Weight 9.92 lb

## Mounting / Installation

Connection type Screw terminal

Mounting part material Stainless steel 1.4404

# Signalling devices



Audible signalling device Sounder

In flameproof enclosure

YA90/C-D-UL-RN-ST-00-00-00 Art. No. 205365

## Mounting / Installation

Note about mounting	Provided
---------------------	----------

## Components

Drilled holes	2 x M20
Cable glands and entries	can be ordered as an accessory
Stopping plugs	1 x 1/2" NPT 1 x dust cap 2 x adaptor M20x1/2"NPT
Stopping plug material	Brass

## Dimensional Drawings (All Dimensions in mm [inches]) – Subject to Alterations

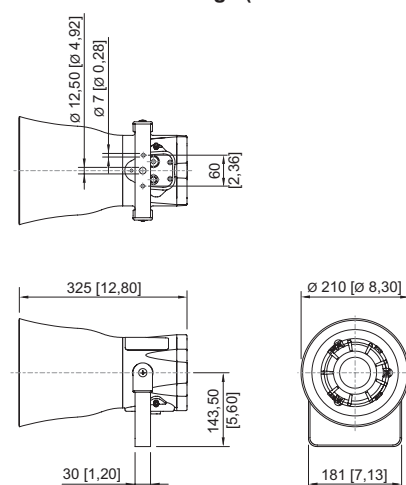



## Accessories

### Mounting accessories

	U-bracket, stainless steel	Art. No. 224587
--	----------------------------	--------------------

### Sun shield

	Fastening kit for pole mounting incl. adaptor plate and screws	Art. No. 267720
	Sun shield YA90 incl. mounting screws	Art. No. 267731

## Signalling devices

Audible signalling device Sounder



In flameproof enclosure

YA90/C-D-UL-RN-ST-00-00-00 Art. No. 205365



### Metal cable gland



### Art. No.

	Ex d and Ex e cable gland with compound for all types of armoured cables (SWA, wire-braid, tape) (nickel-plated brass) Type 20PX2K, M20 x 1.5	109428
	Ex d and Ex e cable glands with RapidEx sealing system for all types of unarmoured cables and wire-braid-armoured cables (nickel-plated brass) Type 20PX2K-REX, M20 x 1.5	246649
	Ex d and Ex e cable glands with compound for all types of unarmoured cables and wire-braid-armoured cables (nickel-plated brass) Type 20PXSS2K, M20 x 1.5	109441
	Ex d and Ex e cable glands with RapidEx sealing system for all types of unarmoured cables and wire-braid-armoured cables (nickel-plated brass) Type 20PXSS2K-REX, M20 x 1.5	246605

### Spare Parts

### Spare PCB assembly kit

### Art. No.

	115 to 230 V AC	209534
	24 V DC	209564

We reserve the right to make alterations to the technical data, dimensions, weights, designs and products available without notice. The illustrations cannot be considered binding.