

Network technology

ISbus fieldbus technology Field device coupler, 8 spurs

for Zone 2 Ex i

9411/24-330-41 Art. No. 206839



- For connecting 8 (FISCO, Entity) fieldbus devices in Zone 2
- Operation on a high-power trunk
- Reduced start-up current thanks to power management and short-circuit limiting with disconnection

MY R. STAHL 9411F



Series 9411/24 Ex i field device couplers for Zone 2 with galvanic separation are used for interference-free connection of up to 8 intrinsically safe FF H1 or PROFIBUS PA field devices to the high-power trunk. The spurs with the ia type of protection can be used for fieldbus devices in Zones 1 and 2 and are protected by a short-circuit limiting function.

The integrated power management minimises start-up and short-circuit currents.

Available with screw or spring clamp terminals.

Technical Data

Explosion Protection

Application range (zones)	2
Ex interface zone	0, 1, 2, 20, 21, 22
IECEX gas certificate	IECEX BVS 08.0057X
IECEX gas explosion protection	Ex nA [ia Ga] IIC T4 Gc
IECEX dust certificate	IECEX BVS 08.0057X
IECEX dust explosion protection	[Ex ia Da] IIIC
ATEX gas certificate	BVS 06 ATEX E 004 X
ATEX gas certificate	BVS 06 ATEX E 004 X
ATEX gas explosion protection	Ex II 3 (1) G Ex nA [ia Ga] IIC T4 Gc
ATEX dust certificate	BVS 06 ATEX E 004 X
ATEX dust explosion protection	Ex II (1) D [Ex ia Da] IIIC
FMus certificate	3026646
cFM certificate	3026646C
Marking cFMus	NI, Class I, Div. 2, Groups A,B,C,D; T4, AIS Class I,II,III, Div. 1, Groups A,B,C,D,E,F,G; Class I, Zone 2, AEx/Ex nA [ia] IIC T4 T4 at Ta = 75°C See Doc. 9411 6 031 004 1
Certificates	ATEX (BVS), Brazil (ULB), Canada (FM), IECEX (BVS), India (PESO), International (FF), USA (FM)
Declaration of Conformity	ATEX (EUK)

Safety Data

Max. voltage U_o	15.7 V
Max. current I_o	245 mA
Max. power P_o	960 mW

Safety Data

Max. permissible external capacity C_o for IIC	476 μ F
Max. permissible external inductance L_o for IIC	0.58 mH
Max. permissible external capacity C_o for IIB	2878 μ F
Max. permissible external inductance L_o for IIB	2.9 mH
Internal capacitance	1.1 nF
Internal inductance	~ 0 mH
Safety-related max. voltage	253 V

Electrical Data

Max. number of field devices per segment	16 (FF H1) 32 (Profibus PA)
Data transmission trunk and spurs	Passive No repeater function
Max. number of field device couplers	4 per trunk
Power Management	If the voltage on the trunk exceeds 16 V, the spurs are switched on consecutively in order to avoid a high start-up current through the field devices. If a spur short circuit is detected, the affected spur is disconnected until the short circuit is removed. The trunk is loaded with max. one short-circuit current, regardless of how many spurs are short-circuited. This minimises the current drawn by the trunk and the power dissipation under all operating conditions.
Fieldbus termination	The field device couplers have a built-in, connectable terminator 100 Ω + 1 μ F (IEC 61158-2). A jumper between the TERM 1 and 2 terminals connects the terminator to the trunk. As an alternative, it is also possible to use a Series 9418 external terminator at the trunk OUT connection.

Auxiliary Power

Max. power dissipation	1.8 W
Auxiliary power	Not required; the field device coupler is supplied from the trunk.

Galvanic Isolation

Galvanic separation Ex i spur/trunk	1500 V AC
Galvanic separation Ex i spur/Ex i spur	No galvanic separation

Input

Trunk connections	2 (IN/OUT) Bridged internally
Trunk version	High power trunk/Ex e
Voltage range	16 – 32 V
Input undervoltage monitoring	< 16 V, spurs de-energised
Max. trunk voltage IN/OUT	2 A
Max. trunk voltage drop IN/OUT	60 mV
Trunk polarity reversal protection	Yes
Trunk earthing	Direct on shield bus Capacitive over 5.2 nF
Max. input current Trunk, voltage 16 V	Without load on spurs: 32 mA Load on spurs 1 x 20 mA: 58 mA Load on spurs 8 x 20 mA: 225 mA Load on spurs 7 x 20 mA + 1 x short circuit: 270 mA

Input

Max. input current Trunk, voltage 32 V	Without load on spurs: 32 mA Load on spurs 1 x 20 mA: 50 mA Load on spurs 8 x 20 mA: 115 mA Load on spurs 7 x 20 mA + 1 x short circuit: 135 mA
--	--

Output

Output voltage	Min. 10 V at 41 mA
Max. number of field devices per spur	1
Max. cable length	120 m
Max. continuous output current DC	20 mA
Output max. short-circuit current	50 mA
Spurs earthing	Direct on shield bus Capacitive over 4.7 nF

Field Device Interface

Spurs version	Intrinsically safe FISCO Ex i
Spurs connections	8
Spurs connection type	Detachable screw terminal

Device Specific Data

Trunk LED operating conditions	"RUN" LED, green
Spurs operating condition LED	"S1" to "S8" LED, yellow
LED error indication	"ERR" LED, red
Error detection	Short circuit ≥ 42 to 50 mA
Short circuit indication	"S1" to "S8" LED Yellow, flashes
Note	The R. STAHL "Fieldbus wizard" tool (r-stahl.com) must be used for correct project engineering.

Diagnostics

LED group error	Red "ERR" LED, flashing
-----------------	-------------------------

Ambient Conditions

Ambient temperature	-40 °C ... 75 °C
Ambient temperature	-40 °F ... +167 °F
Storage temperature	-40 °C ... 75 °C
Storage temperature	-40 °F ... +167 °F
Max. operating altitude	< 2000 m
Max. operating altitude	2000 m
Max. operating altitude, ft	< 6562 ft
Max. relative humidity	95% (without condensation)
Max. relative humidity	95 %
Electromagnetic compatibility	Tested to the following standards and regulations: EN 61326 (IEC/EN 61000-4-1 to 61000-4-6 and 61000-4-11; EN 55022 class B), NAMUR NE21
Note	Coupler mounted on DIN rails

Mechanical Data

Field enclosure	without
Trunk connection type	Screw terminals
Connection terminals	3-pole (+, -, shield)

Mechanical Data

Rigid single-wire connection	Trunk 0.2 to 4 mm ² Spurs 0.2 to 4 mm ²
Flexible single-wire connection	Trunk 0.25 to 2.5 mm ² Spurs 0.25 to 2.5 mm ²
Flexible single-wire connection with sleeve	Trunk 0.25 to 2.5 mm ² Spurs 0.25 to 2.5 mm ²
Degree of protection note	The installation enclosure may be opened during operation in a hazardous area while connected to power.
Degree of protection (IP) (IEC 60529)	IP30 enclosure IP20 Ex i terminals
Module enclosure	PA 6.6
Fire resistance (UL 94)	HB
Pollutant class	Corresponds to G3
Width	208.5 mm
Width, inches	8.21 in
Height	83.3 mm
Depth	128.3 mm
Depth in inches	5.05 in
Mounting depth in inches	3.28 in
Weight	735 g
Weight	1.62 lb

Mounting / Installation

Mounting type	on NS 35/15 DIN rail (DIN EN 60715) On mounting plate (4 x M5 screw)
Tightening torque	2.6 Nm
Mounting orientation	Horizontal Vertical

Components

LED error indication design.	ERR
LED error indication colour	red
LED operating status Trunk col	green

Technical Drawings – Subject to Alterations

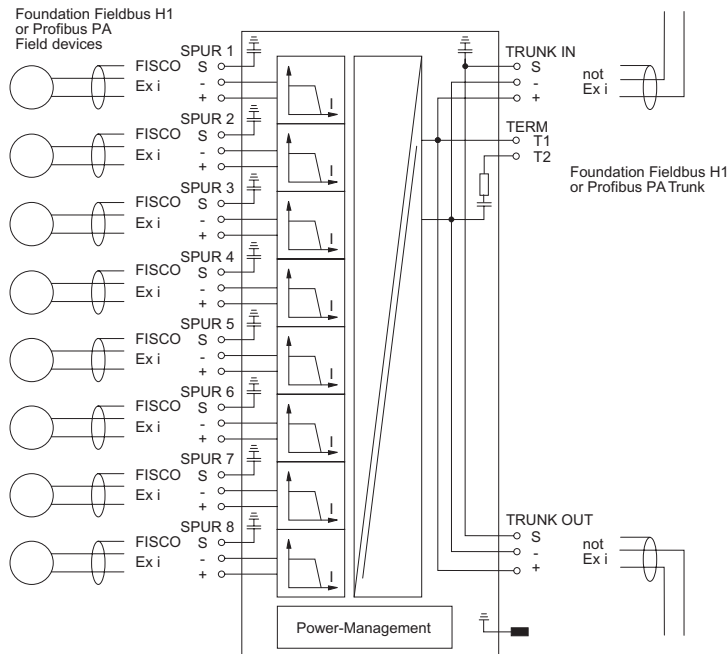

Connection diagram 9411/2.

Dimensional Drawings (All Dimensions in mm [inches]) – Subject to Alterations

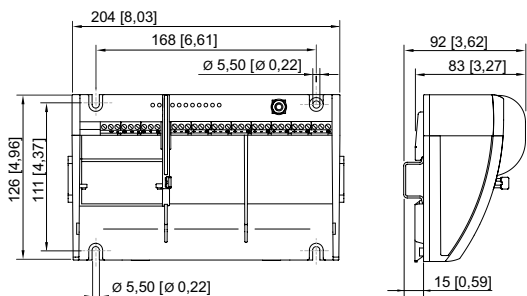

Accessories

Cable for Foundation Fieldbus, PROFIBUS PA

Art. No.

	Cable type: O2YS(St+Ce)Y-fl	169328
	Colour (sheath): Blue Application area: Universal use FISCO, UL listed, sunlight-resistant, oil-resistant, flame retardant	

Cable for FOUNDATION Fieldbus, PROFIBUS PA

Art. No.

	Cable type: O2YS(St+Ce)Y-fl	169328
	Colour (sheath): Orange Application area: Universal use FISCO, UL listed, sunlight-resistant, oil-resistant, flame retardant	

Earthing rail set for 8 spurs

Art. No.

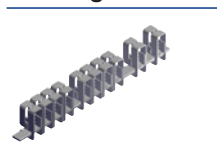
	9411 earthing rail with spring clamp clips	202775
--	--	--------



Network technology



ISbus fieldbus technology Field device coupler, 8 spurs

for Zone 2 Ex i

9411/24-330-41 Art. No. 206839

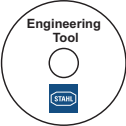
	9411 earthing rail with screw terminals	161930
Fieldbus power supply		Art. No.
	Fieldbus power supply and diagnostics	200586
Fieldbus wizard engineering tool		Art. No.
	Engineering tool for project engineering for Foundation Fieldbus or PROFIBUS PA fieldbus segments Download from r-stahl.com	

We reserve the right to make alterations to the technical data, dimensions, weights, designs and products available without notice. The illustrations cannot be considered binding.