

8562/53-5045-040 Art. No. 214881



- Non-adjustable thermal and magnetic releases
- Isolating function in accordance with EN 60947-2
- Energy limiting class 3

MY R. STAHL 8562B



R. STAHL Series 8562 miniature circuit breakers boast good current limiting for short circuits and a high switching capacity of 6 or 10 kA. This results in a low load on conductors and a high selectivity for upstream fuses. The components have a modular design and are therefore available in 1- to 4-pole versions and for nominal currents from 0.5 to 40 A.

Technical Data

Explosion Protection	
Application range (zones)	1, 2
IECEX gas certificate	IECEX PTB 06.0062U
IECEX gas explosion protection	Ex de IIC T6 Gb
IECEX firedamp certificate	IECEX PTB 06.0062U
IECEX firedamp protection	Ex de I Mb
ATEX gas certificate	PTB 02 ATEX 1049 U
ATEX gas explosion protection	Ex II 2 G Ex de IIC T6 Gb
ATEX firedamp certificate	PTB 02 ATEX 1049 U
ATEX firedamp protection	Ex I M2 Ex de I Mb
Certificates	ATEX (PTB), Brazil (ULB), China (CQST), IECEX (PTB)
Electrical Data	
Rated operational voltage AC	230 V
Rated operational current	4 A
Rated operational current	4 A
Rated switching capacity	10 kA
Type of voltage	AC
Auxiliary contacts	1 change-over contact
N-pole present	Yes
Tripping characteristic	C
No. of poles	2
Ambient Conditions	
Ambient temperature	-20 °C ... 60 °C
Mechanical Data	
Degree of protection (IP)	IP20
Enclosure material	Epoxy resin
Width	72 mm
Length	156 mm

8562/53-5045-040 Art. No. 214881

Mechanical Data

Length in inches	6.14 in
Depth of cut-out	117 mm
Mounting depth in inches	4.61 in
Weight	3.31 lb

Technical Drawings – Subject to Alterations



1-pole + N



Fault signal contact 1 change-over contact for error signal
(only for types 8562/54-2465-160-4 and 8562/54-2475-4: After the switch trips, the fault message contact can be reset manually)

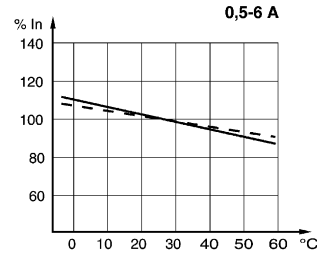

Correction factors for ambient temperatures which deviate from 30 °C

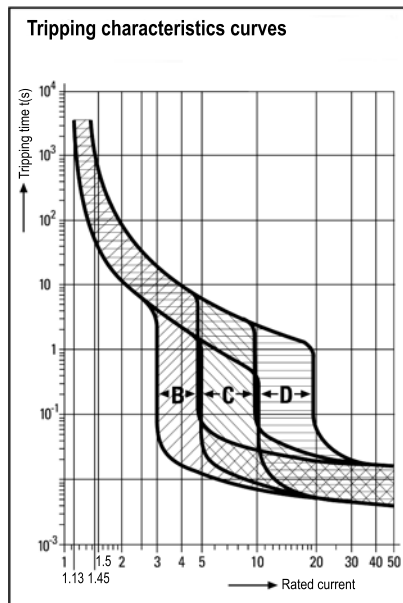

Dimensional Drawings (All Dimensions in mm [inches]) – Subject to Alterations

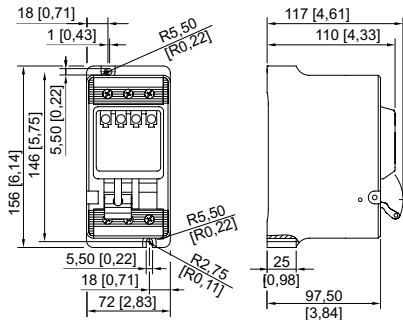

8562/53

We reserve the right to make alterations to the technical data, dimensions, weights, designs and products available without notice. The illustrations cannot be considered binding.