

# Isolators

Transmitter supply unit

Ex i field circuit

9160/13-11-11s Art. No. 214895



- Can be used universally for 2- and 3-wire transmitters and mA sources (4-wire transmitters)
- High accuracy
- For use up to SIL 2, special variant up to SIL 3 (IEC/EN 61508)

MY R. STAHL 9160A



Series 9160 Ex i transmitter supply units are used for the intrinsically safe operation of 2- and 3-wire transmitters or intrinsically safe mA sources such as 4-wire transmitters. The device transmits HART signals in both directions. The range includes one- and two-channel devices, as well as a variant for signal duplication. Special versions are available for lower output voltages and SIL 3.

## Technical Data

Explosion Protection	
Application range (zones)	2
Ex interface zone	0, 1, 2, 20, 21, 22
IECEX gas certificate	IECEX BVS 08.0050 X
IECEX gas certificate	IECEX BVS 08.0050 X
IECEX gas explosion protection	Ex nA nC [ia Ga] IIC T4 Gc
IECEX dust certificate	IECEX BVS 08.0050 X
IECEX dust explosion protection	[Ex ia Da] IIIC
IECEX firedamp certificate	IECEX BVS 08.0050 X
IECEX firedamp protection	[Ex ia Ma] I
ATEX gas certificate	DMT 03 ATEX E 010 X
ATEX gas certificate	DMT 03 ATEX E 010 X
ATEX gas explosion protection	⊕ II 3 (1) G Ex nA nC [ia Ga] IIC T4 Gc
ATEX dust certificate	DMT 03 ATEX E 010 X
ATEX dust explosion protection	⊕ II (1) D [Ex ia Da] IIIC
ATEX firedamp certificate	DMT 03 ATEX E 010 X
ATEX firedamp protection	⊕ I (M1) [Ex ia Ma] I
FMus certificate	FM16US0122X
cFM certificate	FM16CA0067X
Marking cFMus	Class I, Div. 2, Groups A,B,C,D; Class I, Zone 2, nA nC Group IIC AIS Class I,II,III, Div. 1, Groups A,B,C,D,E,F,G; Class I, Zone 0, [Ex ia] IIC T4 Mounting vert. at Ta = 70°C , or horizontal Ta = 60°C See Doc. 91 606 01 31 1
Certificates	ATEX (BVS), Brazil (ULB), Canada (FM), China (NEPSI), IECEX (BVS), Korea (KTL), SIL (exida), USA (FM)
Ship approval	CCS, EU RO MR (DNV)

#### Explosion Protection

Declaration of conformity	ATEX (EUK), China (CCC)
---------------------------	-------------------------

#### Safety Data

Max. voltage $U_o$	27 V				
Max. current $I_o$	88 mA				
Max. power $P_o$	576 mW				
Max. permissible external capacity $C_o$ for IIC	0.09 $\mu$ F				
Max. permissible external inductance $L_o$ for IIC	2.3 mH				
Max. permissible external capacity $C_o$ for IIB	0.705 $\mu$ F				
Max. permissible external inductance $L_o$ for IIB	17 mH				
Max. permissible external capa.IIA	2330 nF				
Max. permissible external inductance $L_o$ for IIA	28 mH				
Max. permissible external capacity $C_o$ for IIIC	0.705 $\mu$ F				
Max. permissible external inductance $L_o$ for IIIC	17 mH				
Max. permissible external capacity $C_o$ for I	3750 nF				
Max. permissible external inductance $L_o$ for I	40 mH				
Max. voltage $U_o$ isolation amplifier	4.1 V				
Max. current $I_o$ isolation amplifier	negligible				
Max. power $P_o$ isolation amplifier	negligible				
Max. voltage $U_i$ isolation amplifier	30 V				
Max. current $I_i$ isolation amplifier	100 mA				
Max. power $P_i$ isolation amplifier	internally limited				
Internal capacitance isolation amplifier	Negligible				
Internal inductance $L_i$ isolation amplifier	Negligible				
Max. voltage $U_i$	30 V				
Max. current $I_i$ note	Internally limited				
Max. power $P_i$	100 mW				
Internal capacitance	Negligible				
Internal inductance	Negligible				
Safety-related max. voltage	253 V AC				
Intrinsically safe limiting values inductance $L_o$ /capacitance $C_o$	Jointly connectable inductance $L_o$ /capacitance $C_o$				
IIC	$L_o$ [mH]	2 mH	1 mH	0.500 mH	0.200 mH
	$C_o$ [ $\mu$ F]	0.042 $\mu$ F	0.056 $\mu$ F	0.072 $\mu$ F	0.090 $\mu$ F
IIB	$L_o$ [mH]	17 mH	2 mH	0.500 mH	0.200 mH
	$C_o$ [ $\mu$ F]	0.290 $\mu$ F	0.320 $\mu$ F	0.460 $\mu$ F	0.600 $\mu$ F
IIA	$L_o$ [mH]	28 mH	2 mH	1 mH	0.200 mH
	$C_o$ [ $\mu$ F]	0.410 $\mu$ F	0.320 $\mu$ F	0.540 $\mu$ F	0.820 $\mu$ F

IIIC	L <sub>o</sub> [mH]	17 mH	2 mH	0.500 mH	0.200 mH
	C <sub>o</sub> [μF]	0.290 μF	0.320 μF	0.460 μF	0.600 μF
I	L <sub>o</sub> [mH]	40 mH	20 mH	0.500 mH	0.100 mH
	C <sub>o</sub> [μF]	0.480 μF	0.660 μF	0.810 μF	1.200 μF

#### Functional Safety

SIL	2
HFT	0
SFF	85%
Lambda SD	0 FIT
Lambda SU	0 FIT
Lambda DD	163 FIT
Lambda DU	28 FIT
PFD <sub>avg</sub> at T <sub>proof</sub> 1 year	2,29E-04
PFD <sub>avg</sub> at T <sub>proof</sub> 2 years	3,38E-04
PFD <sub>avg</sub> at T <sub>proof</sub> 5 years	6,64E-04

#### Electrical Data

Number of channels	1
Transmitter feed operation	Yes
Isolation amplifier operation	Yes
LFD relay	Yes
Communication signal	HART, 0.5 to 10 kHz

#### Auxiliary Power

Auxiliary power	24 V DC
Auxiliary power nominal voltage	24 V DC
Auxiliary power voltage range	18 to 31.2 V
Voltage range residual ripple	≤ 3,6 V <sub>SS</sub>
Nominal current	88 mA
Max. power dissipation	1.7 W
Power consumption	2.1 W
Polarity reversal protection	Yes
Undervoltage monitoring	Yes
Operation indication	Green "PWR" LED

#### Galvanic Isolation

Test voltage as per standard	EN IEC 60079-11
Ex i input to output	1.5 kV AC
Ex i input to auxiliary power	1.5 kV AC
Ex i input to fault message contact	1.5 kV AC
Test voltage as per standard	EN 50178
Output to auxiliary power	350 V AC
Galvanic separation FMC to HE and output	350 V AC

#### Input

Input function	Isolation amplifier Transmitter power unit
Input	0/4 ... 20 mA with HART
Input signal	0/4 to 20 mA with HART

#### Input

Function range input	0 ... 24 mA
Max. input current, mA sources	50 mA
Input for open-circuit voltage $U_a$	$\leq 26$ V
Short-circuit current	$\leq 35$ mA
Supply voltage for transmitter	$\geq 16$ V at 20 mA
Input resistance	$\leq 100$ ohm

#### Output

Output	0/4 to 20 mA with HART
Output signal	0/4 to 20 mA with HART
Function range output	0 – 24 mA
Output A	0/4 to 20 mA
Behaviour of the output	= input signal
Output current at $I_e=0$	0 mA
Output residual ripple	$\leq 40$ $\mu$ Aeff
Load resistance $R_L$	0 ... 600 $\Omega$ (terminal 1+/2- resp. 5+/6-) 0 ... 379 $\Omega$ (terminal 3+/2- resp. 4+/6-) (With internal 221 ohm resistor for HART)
Settling time 10-90%	$\leq 100$ $\mu$ s
LF switch user adjustment	Activated/deactivated
Wire breakage error detection input	< 3.6 mA
Short circuit error detection input	> 20.5 mA
Wire break. err detection OFF	< 3,6 mA
Line fault indication	Red &quot;LF&quot; LED
Fault message contact switching capacity	30 V / 100 mA
Line fault and loss of power signalisation	- Contact (30 V/100 mA), closed against earth in case of error - pac-Bus, potential-free contact (30 V/100 mA)
Deviations / error note	Information in % of the measuring range (20 mA) at $U_N$ , 23 °C
Deviation	$\leq 0,1$ %
Temperature influence error limits	$\leq 0.05\%$ / 10 K

#### Device Specific Data

Operating status LED designation	PWR
Operating conditions LED colour	green

#### Ambient Conditions

Ambient temperature	-20 °C ... 70 °C (Single device) -20 °C ... 60 °C (Group assembly)
Ambient temperature	-4 °F ... +158 °F (Single device) -40 °F ... +140 °F (Group assembly)
Note	Installation conditions influence the ambient temperature. Please observe the "Cabinet installation guide".
Storage temperature	-40 °C ... 80 °C
Storage temperature	-40 °F ... +176 °F
Maximum relative humidity	95%
Use at the height of	< 2000 m
Max. operating altitude	2000 m
Electromagnetic compatibility	Tested to the following standards and regulations: EN 61326-1 For use in industrial areas; NAMUR NE 21

#### Mechanical Data

Degree of protection (IP)	IP30
Degree of protection (IP) terminals	IP20
Fire resistance (UL 94)	V0
Enclosure material	Polyamide
Connection cross-section	0.2 to 2.5 mm <sup>2</sup> flexible 0.25 to 2.5 mm <sup>2</sup> flexible with core end sleeve
Grid dimension	17.6 mm
Width	17.6 mm
Width, inches	0.69 in
Height	114.5 mm
Height in inches	4.51 in
Length	108 mm
Length in inches	4.25 in
Weight	195 g
Weight	0.43 lb

#### Mounting / Installation

Mounting type	DIN rail NS35/15, NS35/7.5
Mounting orientation	Vertical Horizontal
Connection type	Screw terminal
Min. rigid conductor cross section	0.2 mm <sup>2</sup>
Max. rigid conductor cross section	2.5 mm <sup>2</sup>
Min. flex conductor cross section	0.2 mm <sup>2</sup>
Max. flex conductor cross section	2.5 mm <sup>2</sup>
Connection cross-section AWG	24 ... 14

#### Technical Drawings – Subject to Alterations

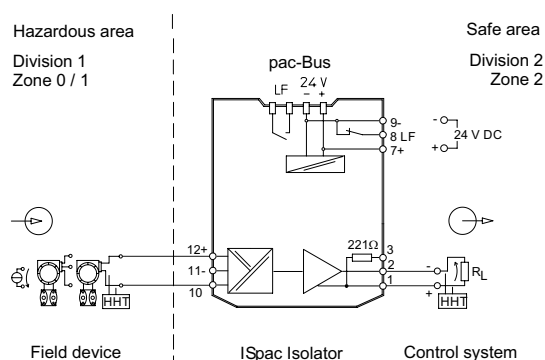

Connection diagram 9160/13-11-11

# Isolators

Transmitter supply unit

Ex i field circuit

9160/13-11-11s Art. No. 214895



## Dimensional Drawings (All Dimensions in mm [inches]) – Subject to Alterations

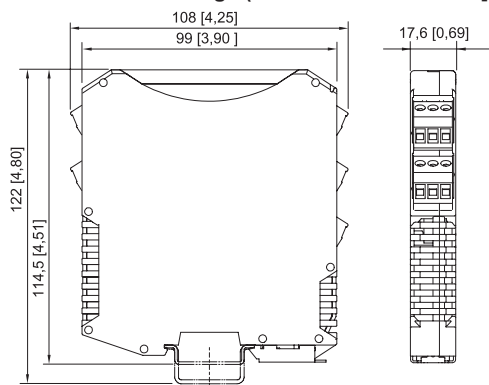

ISpac Series 9143, 9146, 9147, 9160, 9162, 9163, 9165, 9167, 9170, 9172, 9175, 9176, 9180, 9182, 9193, ISbus Series 9412 with screw terminal

## Accessories

### Transparent cover



For 91xx ISpac modules  
Yellow, transparent  
Clear identification of the device for SIL applications.  
(Packaging unit: 10 pieces)

Art. No.

200914

### pac-Bus

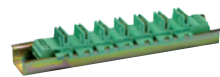

Wiring auxiliary power and collective error message

Art. No.

160731

### Terminal set for pac-Bus

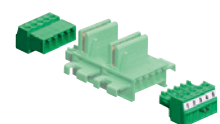

For the supply of 24 V DC auxiliary power via terminals (alternative to using the supply module 9193/21-11-11), with jumper for error message chain for ISpac module 91xx

Art. No.

160730

## Spare Parts

### Screw terminal



3-pole plug, screw connector  
thread: M3  
stripping length: 7 mm  
colour: green

Art. No.

112817



3-pole plug, screw connector  
thread: M3  
stripping length: 7 mm  
colour: black

Art. No.

112816



3-pole plug, screw connector  
thread: M3  
stripping length: 7 mm  
colour: blue

Art. No.

112818

# Isolators

Transmitter supply unit



Ex i field circuit

9160/13-11-11s Art. No. 214895





## Screw terminal with test tap

Art. No.

	3-pole plug with test tap, screw connector thread: M3 stripping length: 7 mm colour: black	113005
	3-pole plug with test tap, screw connector thread: M3 stripping length: 7 mm colour: blue	113004

## Spring clamp terminal

Art. No.

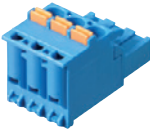
	3-pole plug with test tap, spring clamp connection stripping length: 10 mm colour: green	112825
	3-pole plug with test tap, spring clamp connection stripping length: 10 mm colour: black	112824
	3-pole plug with test tap, spring clamp connection stripping length: 10 mm colour: blue	112826

We reserve the right to make alterations to the technical data, dimensions, weights, designs and products available without notice. The illustrations cannot be considered binding.