

8562/54-4040-060 Art. No. 215083



- Non-adjustable thermal and magnetic releases
- Isolating function in accordance with EN 60947-2
- Energy limiting class 3

MY R. STAHL 8562B



R. STAHL Series 8562 miniature circuit breakers boast good current limiting for short circuits and a high switching capacity of 6 or 10 kA. This results in a low load on conductors and a high selectivity for upstream fuses. The components have a modular design and are therefore available in 1- to 4-pole versions and for nominal currents from 0.5 to 40 A.

## Technical Data

### Explosion Protection

Application range (zones)	1, 2
IECEX gas certificate	IECEX PTB 06.0062U
IECEX gas explosion protection	Ex de IIC T6 Gb
IECEX firedamp certificate	IECEX PTB 06.0062U
IECEX firedamp protection	Ex de I Mb
ATEX gas certificate	PTB 02 ATEX 1049 U
ATEX gas explosion protection	Ex II 2 G Ex de IIC T6 Gb
ATEX firedamp certificate	PTB 02 ATEX 1049 U
ATEX firedamp protection	Ex I M2 Ex de I Mb
Certificates	ATEX (PTB), Brazil (ULB), China (CQST), IECEX (PTB)

### Electrical Data

Rated operational voltage AC	400 V
Rated operational current	6 A
Rated operational current	6 A
Rated switching capacity	10 kA
Type of voltage	AC
N-pole present	Yes
Tripping characteristic	C
No. of poles	4

### Ambient Conditions

Ambient temperature	-20 °C ... 60 °C
---------------------	------------------

### Mechanical Data

Degree of protection (IP)	IP20
Enclosure material	Epoxy resin
Length	156 mm
Length in inches	6.14 in
Depth of cut-out	117 mm

8562/54-4040-060 Art. No. 215083

**Mechanical Data**

Mounting depth in inches	4.61 in
Weight	3.97 lb

**Technical Drawings – Subject to Alterations**

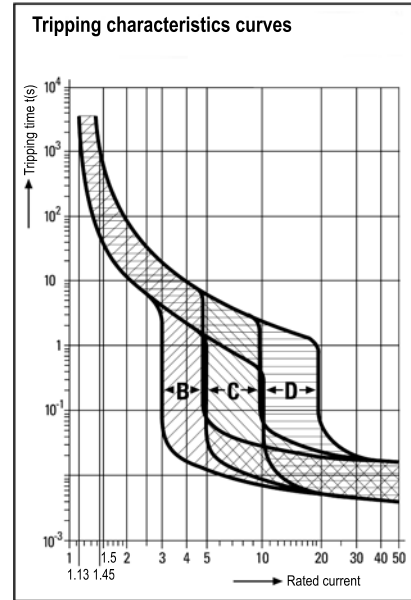
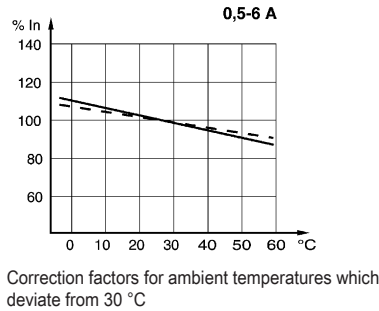
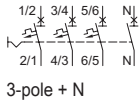

**Dimensional Drawings (All Dimensions in mm [inches]) – Subject to Alterations**

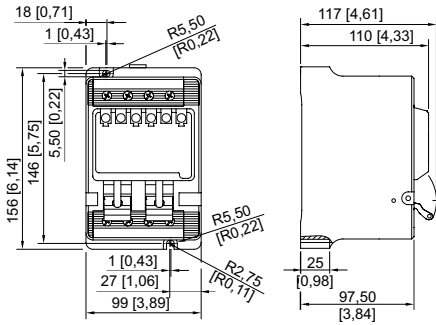

8562/54

We reserve the right to make alterations to the technical data, dimensions, weights, designs and products available without notice. The illustrations cannot be considered binding.