

Components for system solutions

Residual current Miniature circuit breaker

Miniature circuit breaker

8562/54-2376-160 Art. No. 215708



- Residual current monitoring and tripping in the event of over-voltage
- Combination of residual current circuit breaker and miniature circuit breaker: Saves space, reduces installation requirements
- Good current limiting in the event of a short circuit

MY R. STAHL 8562C



The R. STAHL Series 8562 residual current circuit breaker with overcurrent release is a residual current circuit breaker and 2-pole switching miniature circuit breaker in one: It measures residual currents and triggers in the event of overvoltage, thereby protecting the conductors in your systems from overload, earth faults and short circuits. Its excellent current limiting feature reduces the load on the conductor in the event of a short circuit.

Technical Data

Explosion Protection

| | |
|--------------------------------|---------------------------------------|
| Application range (zones) | 1, 2 |
| IECEX gas certificate | IECEX PTB 06.0062U |
| IECEX gas explosion protection | Ex de IIC T5 Gb |
| IECEX firedamp certificate | IECEX PTB 06.0062U |
| IECEX firedamp protection | Ex de I Mb |
| ATEX gas certificate | PTB 02 ATEX 1049 U |
| ATEX gas explosion protection | Ex II 2 G Ex de IIC T5 Gb |
| ATEX firedamp certificate | PTB 02 ATEX 1049 U |
| ATEX firedamp protection | Ex I M2 Ex de I Mb |
| FMus certificate | 3033692 |
| cFM certificate | 3033692C |
| cCSA certificate | 1850696 |
| Certificates | ATEX (PTB), China (CQST), IECEX (PTB) |

Electrical Data

| | |
|------------------------------|----------------------------|
| Rated operational voltage AC | 133 ... 230 V |
| Rated operational current | 16 A |
| Rated operational current | 16 A (T5) |
| Rated switching capacity | 10 kA |
| Type of voltage | AC |
| Rated residual current | 0.1 A |
| Auxiliary contacts | 2 change-over contact |
| Auxiliary contacts 2 | 1 normal 1 error signal |
| N-pole present | No |
| Tripping characteristic | B |
| No. of poles | 2 |

Components for system solutions

Residual current Miniature circuit breaker

Miniature circuit breaker

8562/54-2376-160 Art. No. 215708



Mechanical Data

| | |
|---------------------------|-------------|
| Degree of protection (IP) | IP20 |
| Enclosure material | Epoxy resin |
| Length | 156 mm |
| Length in inches | 6.14 in |
| Depth of cut-out | 125 mm |
| Mounting depth in inches | 4.92 in |
| Weight | 1.8 kg |
| Weight | 3.97 lb |

Technical Drawings – Subject to Alterations



Auxiliary contact 1 change-over contact
Fault signal contact 1 change-over contact

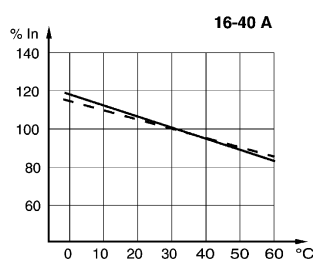

Correction factors for ambient temperatures which deviate from 30 °C

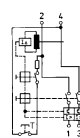

2-pole

Dimensional Drawings (All Dimensions in mm [inches]) – Subject to Alterations

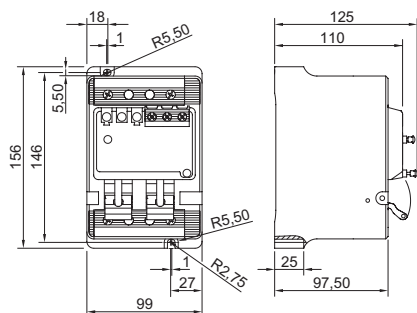

8562/54-2376-160, 2-pole with auxiliary contact and reset function

We reserve the right to make alterations to the technical data, dimensions, weights, designs and products available without notice. The illustrations cannot be considered binding.