

# Components for system solutions

## Residual current Miniature circuit breaker

### Miniature circuit breaker

8562/52-5270-200 Art. No. 223075



- Residual current monitoring and tripping in the event of over-voltage
- Combination of residual current circuit breaker and miniature circuit breaker: Saves space, reduces installation requirements
- Good current limiting in the event of a short circuit

MY R. STAHL 8562C



The R. STAHL Series 8562 residual current circuit breaker with overcurrent release is a residual current circuit breaker and 2-pole switching miniature circuit breaker in one: It measures residual currents and triggers in the event of overvoltage, thereby protecting the conductors in your systems from overload, earth faults and short circuits. Its excellent current limiting feature reduces the load on the conductor in the event of a short circuit.

## Technical Data

### Explosion Protection

Application range (zones)	1, 2
IECEX gas certificate	IECEX PTB 06.0062U
IECEX gas explosion protection	Ex de IIC T5 Gb
IECEX firedamp certificate	IECEX PTB 06.0062U
IECEX firedamp protection	Ex de I Mb
ATEX gas certificate	PTB 02 ATEX 1049 U
ATEX gas explosion protection	Ex II 2 G Ex de IIC T5 Gb
ATEX firedamp certificate	PTB 02 ATEX 1049 U
ATEX firedamp protection	Ex I M2 Ex de I Mb
FMus certificate	3033692
cFM certificate	3033692C
cCSA certificate	1850696
Certificates	ATEX (PTB), Brazil (ULB), China (CQST), IECEX (PTB)

### Electrical Data

Rated operational voltage AC	127 ... 230 V
Rated operational current	20 A
Rated operational current	20 A (T5)
Rated switching capacity	10 kA
Type of voltage	AC
Rated residual current	0.03 A
N-pole present	Yes
Tripping characteristic	C
No. of poles	2

### Mechanical Data

Degree of protection (IP)	IP20
Enclosure material	Epoxy resin

# Components for system solutions

## Residual current Miniature circuit breaker

### Miniature circuit breaker

8562/52-5270-200 Art. No. 223075



#### Mechanical Data

Width	54 mm
Length	156 mm
Length in inches	6.14 in
Depth of cut-out	97.5 mm
Mounting depth in inches	3.84 in
Weight	2.65 lb

#### Technical Drawings – Subject to Alterations

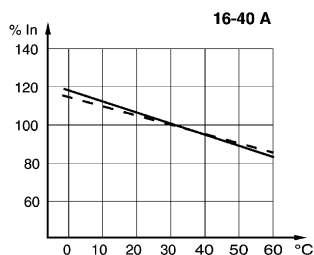

Correction factors for ambient temperatures which deviate from 30 °C

#### Dimensional Drawings (All Dimensions in mm [inches]) – Subject to Alterations

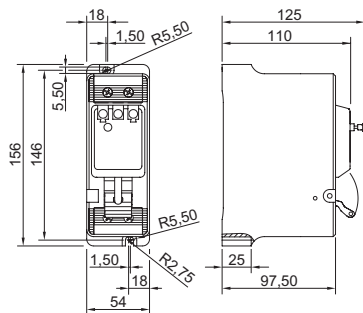

8562/52-....., 1-pole + N

We reserve the right to make alterations to the technical data, dimensions, weights, designs and products available without notice. The illustrations cannot be considered binding.