

8252/02 Art. No. 241567



MY R. STAHL 8252C

Technical Data

Explosion Protection

Application range (zones)	1, 2, 21, 22
IECEX gas certificate	IECEX BVS 11.0038 U
IECEX gas explosion protection	Ex db IIC Gb
IECEX dust certificate	IECEX BVS 11.0038 U
IECEX dust explosion protection	Ex tb IIIC Db
ATEX gas certificate	BVS 11 ATEX E 052 U
ATEX gas explosion protection	Ex II 2 G Ex db IIC Gb
ATEX dust certificate	BVS 11 ATEX E 052 U
ATEX dust explosion protection	Ex II 2 D Ex tb IIIC Db
Certificates	ATEX (BVS), China (NEPSI), IECEX (BVS)

Ambient Conditions

Ambient temperature	-60 °C ... +70 °C
---------------------	-------------------

Mechanical Data

Degree of protection (IP)	IP66
Enclosure material	Cast aluminium alloy, Copper-free, powder-coated
Enclosure colour	Light grey (RAL 7032)
Width	106 mm
Height	106 mm
Depth	88 mm
Built-in components	According to the order
Enclosure size	2
Floor openings (BASE)	According to the order
Left openings (180°)	According to the order
Top openings (90°)	According to the order
Right openings (0°)	According to the order
Bottom openings (270°)	According to the order
Weight	-

8252/02 Art. No. 241567

Dimensional Drawings (All Dimensions in mm [inches]) – Subject to Alterations

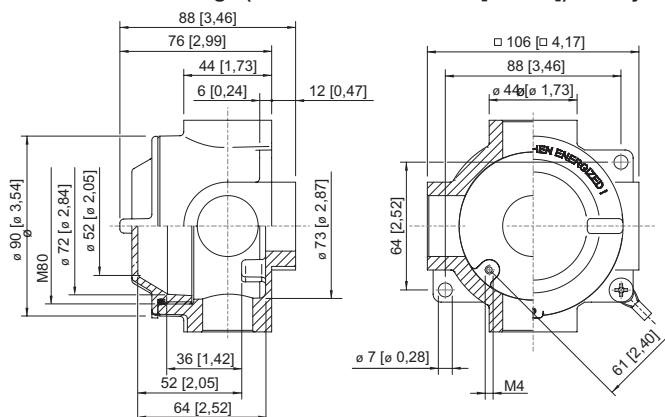

We reserve the right to make alterations to the technical data, dimensions, weights, designs and products available without notice. The illustrations cannot be considered binding.