

# Lighting

## Linear luminaire With LED

GRP

6402/4148-9100-152-1110-11-8500-C2230 Art. No. 307337



- State-of-the-art LED technology with high luminous efficacy and long service life
- Extremely high luminaire efficacy
- Luminous flux after 100,000 h still 90% of the starting luminous flux
- Optionally with DALI for controlling and monitoring the luminaire
- Optionally with address modules for directly actuation of a common battery system

MY R. STAHL 6402C



The linear luminaire with Series 6402/4 LED is ideal for lighting surfaces at a mounting height of up to 10 m. It can also be used to illuminate equipment and objects, both inside and outside. The pole mounting sleeve accessory can be used to easily mount the luminaire on poles. Optionally, the luminaire can be equipped with an address module. It can be used to control and monitor the luminaire for the common battery systems.

### Technical Data

Explosion Protection	
Ex version	Yes
Application range (zones)	2, 21, 22
IECEX gas certificate	IECEX IBE 14.0080
IECEX gas certificate	IECEX IBE 14.0080
IECEX gas explosion protection	Ex ec IIC T4 Gc
IECEX dust certificate	IECEX IBE 14.0080
IECEX dust explosion protection	Ex tb op is / tc IIIC T100 °C Db
ATEX gas certificate	IBExU 14 ATEX 1292
ATEX gas certificate	IBExU 14 ATEX 1292
ATEX gas explosion protection	⊕ II 3 G Ex ec IIC T4 Gc
ATEX dust certificate	IBExU 14 ATEX 1292
ATEX dust explosion protection	⊕ II 2 D Ex tb op is / tc IIIC T100 °C Db
Certificates and approvals	ATEX IECEX UKEX
Certificates	ATEX (IBE), IECEX (IBE)
Declaration of Conformity	ATEX (EUK), Declaration of Conformity (AUS)
Electrical Data	
Rated operational voltage AC	220 ... 240 V
Rated operational voltage DC	196 ... 250 V
Frequency range	50 – 60Hz
Lighting Data	
Number of lamps	1
Lamp wattage	42 W
Lamp	LED
Light colour	5000 K – neutral white

# Lighting

## Linear luminaire With LED

### GRP

6402/4148-9100-152-1110-11-8500-C2230 Art. No. 307337



#### Lighting Data

Light distribution	120°x120° with diffusing glass
Luminaire efficacy	138 lm/W
Luminous flux	5810 lm
Colour rendering	≥ 80
Colour temperature	5000 K

#### Ambient Conditions

Ambient temperature	-40 °C ... 50 °C (T100 °C) Note: Through wiring Max. 3x16 A -40 °C ... 55 °C (T100 °C) Note: Through wiring 2 Max. 3x10 A
---------------------	--

#### Mechanical Data

Version	Special version
IP degree of protection (IEC 60598)	IP66/IP67
Enclosure material	Polyester resin, Glass fibre reinforced
Enclosure colour	Light grey (RAL 7035)
Diffuser	With diffuser
Sealing material	Silicone
Silicone-free content	Contains silicone
Translucent cover material	Polycarbonate
Installed terminal strip	PE + N + L1 + L2 + L3
Max. solid connection terminals	6 mm <sup>2</sup>
Max. finely stranded connection terminals	4 mm <sup>2</sup>
Type of connection cable	Finely stranded Solid
Size	4
Width	184 mm
Height	125 mm
Length	1310 mm
Impact strength (IEC 62262)	IK10
Weight	5.6 kg
Weight	12.35 lb
Disconnection of the luminaire	No

#### Components

Threaded plate	2x plastic
Ballast	CG Luxtronic 48 W 300mA (91)
Through wiring	With 5 conductors 2.5 mm <sup>2</sup>
Drilled holes	3 x M25
Cable glands and entries	2 x M25 Ø 7 ...
Material cable gland	Polyamide, black
Stopping plugs	2 x M25 x 1.5
Stopping plug material	Polyamide, black
Accessories	Provided

#### Dimensional Drawings (All Dimensions in mm [inches]) – Subject to Alterations

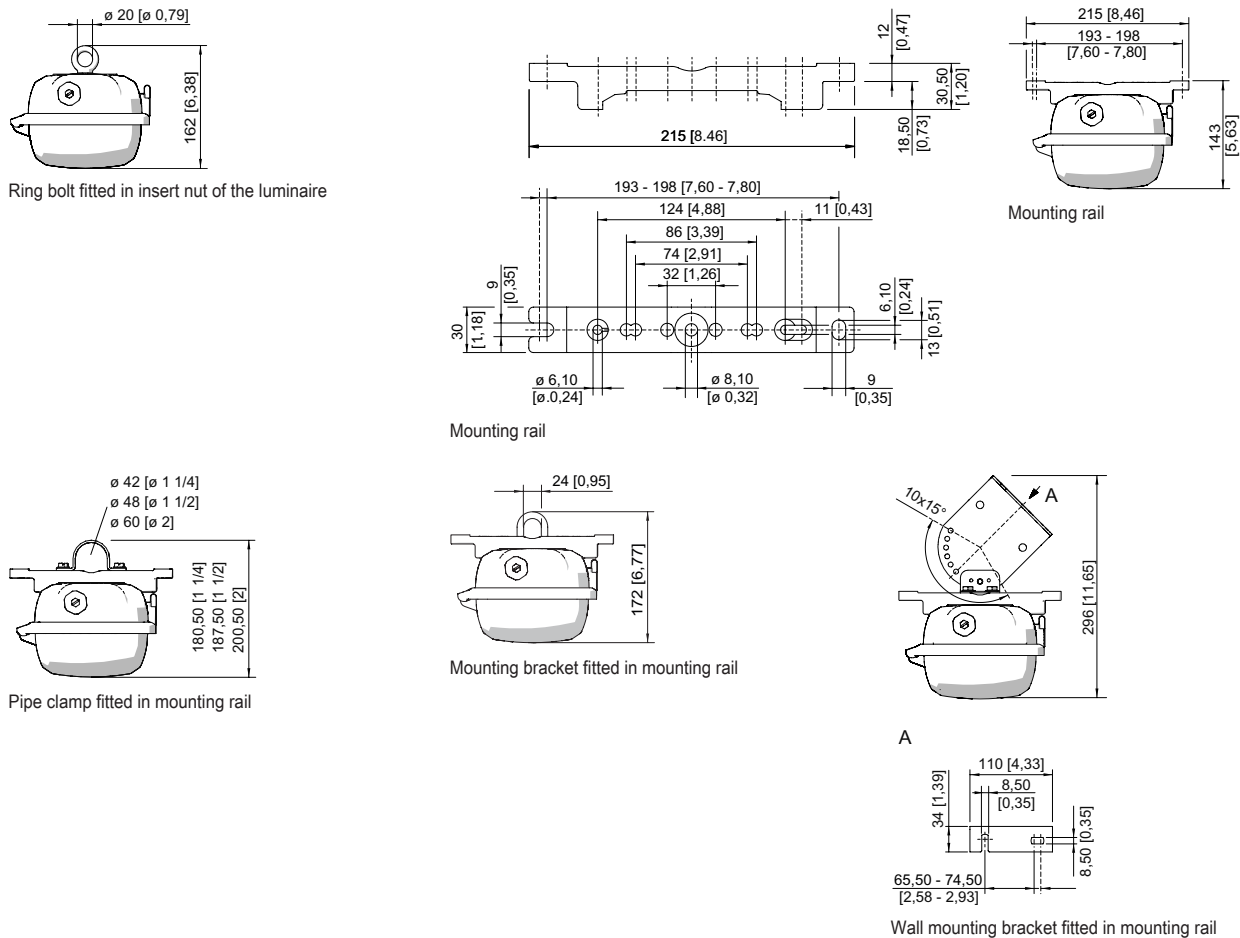

## Accessories

### Box spanner

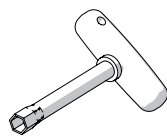

M8 / A/F 13;  
For actuating the central lock

Art. No.

222430

### Breather

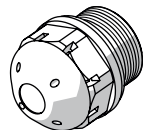

Thread: M25 x 1.5 (20 pieces); without jam nut

Art. No.

285780

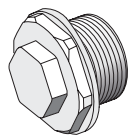

Thread: M25 x 1.5 (1 piece); for installation in light fittings; made from stainless steel; without jam nut

Art. No.

296608

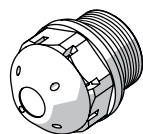

M25 x 1.5 in order to avoid condensate formation

Art. No.

115738

# Lighting

## Linear luminaire With LED

GRP

6402/4148-9100-152-1110-11-8500-C2230 Art. No. 307337

STAHL

### Ceiling and wall mounting bracket

Art. No.

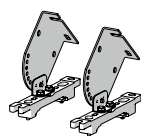

mounted on a mounting rail for a variable mounting distance; Material: stainless steel; Lamp can be swiveled in steps of 15°; 1 pair

222827

### Holder for translucent cover

Art. No.



The fall prevention system for the light fitting cover prevents the light fitting cover from falling accidentally when the light fitting is opened.

222691

### Mounting bracket

Art. No.

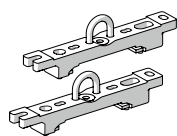

mounting clamp mounted on a mounting rail for a variable mounting distance; 1 pair

222456

### Mounting rail

Art. No.

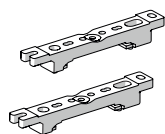

for a variable mounting distance; 1 pair

222826

### Pipe clamp

Art. No.

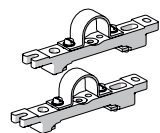

R 1 1/2"; with mounting rail for a variable mounting distance; material: stainless steel; 1 pair

222459

R 1 1/4"; with mounting rail for a variable mounting distance; Material: stainless steel; 1 pair

222458

R 2"; with mounting rail for a variable mounting distance; Material: stainless steel; 1 pair

222460

### Pole mounting sleeve

Art. No.



for the subsequent mounting on lights size 2 and size 4, completely with assembly parts (for pipe diameter 42 mm)

227512

### Protection against accidental contact

Art. No.

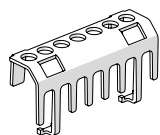

The protection against accidental contact prevents maintenance technicians and electrical installers from accidentally touching conductive parts. The degree of protection is increased to IP20 when the protection against accidental contact is used.

283153

### Ring bolt

Art. No.



M8, direct mounting in insert nuts; 1 pair

115736

We reserve the right to make alterations to the technical data, dimensions, weights, designs and products available without notice. The illustrations cannot be considered binding.