

# Signalling devices



Audible signalling device Sounder

In flameproof enclosure

YA90/C-N-EN-RN-ST-TL-00-00 Art. No. 258125



- Horn: Directional/max. 115 dB(A)
- Type of protection: Ex d
- Class: IP66 (IEC 60529)
- Corrosion-resistant GRP enclosure
- Including fastening bracket
- 32 standardised preconfigured signal tones (compatible with PFEER/UKOOA)
- Two separate signal tones can be selected
- Connection for telephone systems can be ordered as an option
- Optional line monitoring

MY R. STAHL YA90A



The YA90 product series provides directional, audible signals and is intended for use in hazardous or extremely harsh environments.

## Technical Data

### Explosion Protection

Area of application	IECEX European Union (ATEX)
Application range (zones)	1, 2, 21, 22
IECEX gas certificate	IECEX BAS 08.0061X
IECEX gas explosion protection	Ex d IIC T6 Gb
IECEX dust certificate	IECEX BAS 08.0061X
IECEX dust explosion protection	Ex tb IIIC T85 °C Db
ATEX gas certificate	Baseefa 08 ATEX 0189 X
ATEX gas explosion protection	⊕ II 2 G Ex d IIC T6 Gb
ATEX dust certificate	Baseefa 08 ATEX 0189 X
ATEX dust explosion protection	⊕ II 2 D Ex tb IIIC T85 °C Db
Certificates	ATEX (BAS), IECEX (BAS)

### Electrical Data

Rated operational voltage AC	230 V
Rated operational current	0.045 A (T6)
Tolerance	-10 ... 10 %

### Acoustic Data

Sound pressure level	max. 115 dB(A) @ 1 m
Tone selection	Via DIL switch
Sound level	2

# Signalling devices

Audible signalling device Sounder

In flameproof enclosure

YA90/C-N-EN-RN-ST-TL-00-00 Art. No. 258125



Polar diagram

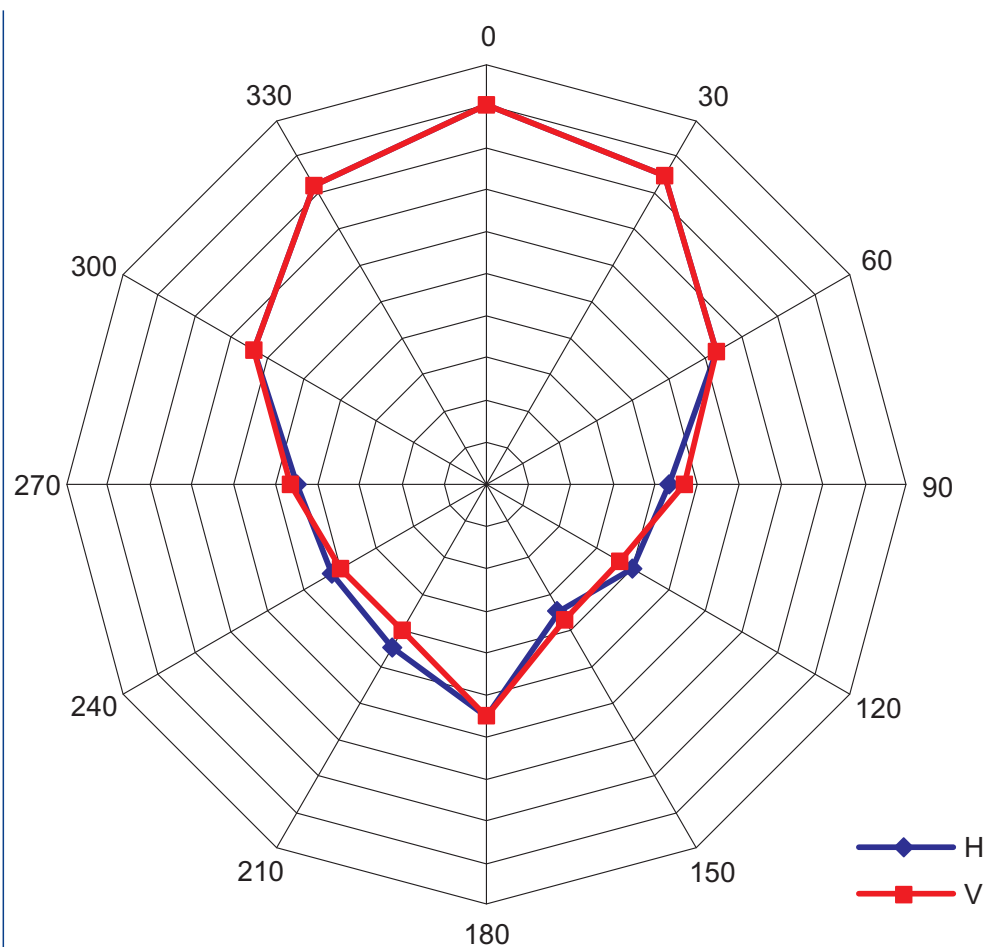

## Ambient Conditions

Ambient temperature -60 °C ... +60 °C

## Mechanical Data

Degree of protection (IP) (IEC 60529)	IP66
Enclosure material	Polyester (GRP), Glass fibre reinforced
Enclosure colour	Red (RAL 3001)
Trumpet material	ABS, flame retardant
Width	325 mm
Height	210 mm
Length	210 mm
Weight	4.5 kg
Weight	9.92 lb

## Mounting / Installation

Connection type	Screw terminal
Mounting part material	Stainless steel 1.4404
Note about mounting	Provided

## Components

Drilled holes	2 x M20
Cable glands and entries	can be ordered as an accessory
Stopping plugs	1 x M20 x 1.5 1 x dust cap
Stopping plug material	Brass

# Signalling devices

Audible signalling device Sounder

In flameproof enclosure





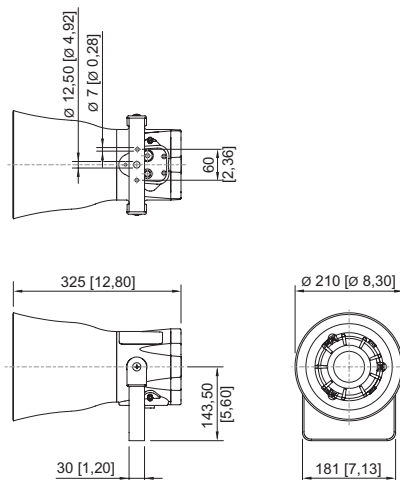

YA90/C-N-EN-RN-ST-TL-00-00 Art. No. 258125



Dimensional Drawings (All Dimensions in mm [inches]) – Subject to Alterations



## Accessories

Mounting accessories		Art. No.
	U-bracket, stainless steel	224587
Sun shield		Art. No.
	Fastening kit for pole mounting incl. adaptor plate and screws	267720
	Sun shield YA90 incl. mounting screws	267731
Metal cable gland		Art. No.
	Ex d and Ex e cable gland with compound for all types of armoured cables (SWA, wire-braid, tape) (nickel-plated brass) Type 20PX2K, M20 x 1.5	109428
	Ex d and Ex e cable glands with RapidEx sealing system for all types of unarmoured cables and wire-braid-armoured cables (nickel-plated brass) Type 20PX2K-REX, M20 x 1.5	246649
	Ex d and Ex e cable glands with compound for all types of unarmoured cables and wire-braid-armoured cables (nickel-plated brass) Type 20PXSS2K, M20 x 1.5	109441
	Ex d and Ex e cable glands with RapidEx sealing system for all types of unarmoured cables and wire-braid-armoured cables (nickel-plated brass) Type 20PXSS2K-REX, M20 x 1.5	246605

## Spare Parts

Spare PCB assembly kit	Art. No.
------------------------	----------



## Signalling devices

Audible signalling device Sounder

In flameproof enclosure

YA90/C-N-EN-RN-ST-TL-00-00 Art. No. 258125



	115 to 230 V AC	209534
	24 V DC	209564

We reserve the right to make alterations to the technical data, dimensions, weights, designs and products available without notice. The illustrations cannot be considered binding.