

Control and signalling devices

Contact element for front installation



Ex e

8082C3-21-2-0 Art. No. 315696



- Wide selection of different actuators
- Versions as NC with positive opening, NO or disconnect terminal

MY R. STAHL 8082D



R. STAHL Series 8082 contact elements have an NO contact and a positive opening NC contact, either made of silver-nickel or gold-plated. They can easily be combined to form contact blocks and enable customised installations, in part due to the wide selection of different actuators.

Technical Data

Explosion Protection

Area of application	European Union (ATEX) CE Code IECEX NEC®
Application range (zones)	1, 2
IECEX gas certificate	IECEX PTB 17.0037U
IECEX gas certificate	IECEX PTB 17.0037U
IECEX gas explosion protection	Ex db eb IIC T6 / T5 Gb
ATEX gas certificate	PTB 17 ATEX 1012 U
ATEX gas explosion protection	Ex II 2 G Ex db eb IIC T6 / T5 Gb
UL gas certificate	E182378V1S9
Marking cULus	Class I, Div. 2, Groups A,B,C,D; Class I, Zone 1, AEx/Ex db eb IIC
Certificates	ATEX (PTB), Brazil (ULB), Canada (UL), China (CQST), IECEX (PTB), Korea (KTL), USA (UL)
Notes	Product label may vary. Series devices are labelled with ATEX, IECEX, NEC® and CE Code.

Electrical Data

Max. rated operational voltage	550 V
Min. rated operational voltage	24 V
Rated operational current	150 mA / 0 A
Rated operational current note	- Gold-plated contacts: 10 to 150 mA switching current - Silver-nickel contacts for a switching current of 150 mA and above - For switching currents < 100 mA in corrosive environments and offshore applications, the use of 8208 snap-action switches is recommended.
Electrical service life	10 ⁸ operating cycles
Mechanical service life	10 ⁸ operating cycles
Switching capacity AC-12	250 V / 10 A 400 V / 7.5 A 550 V / 5 A

Control and signalling devices

Contact element for front installation



Ex e

8082C3-21-2-0 Art. No. 315696

Electrical Data

Switching capacity AC-15	110 V / 10 A 250 V / 6 A 400 V / 4 A
Switching capacity DC-13	110 V / 1 A
Switching capacity DC-13<SoftReturn/>2 contact elements in series	60 V/6 A 110 V/2.5 A 250 V/1.25 A

Ambient Conditions

Ambient temperature	-60 °C ... +70 °C (T6) -60 °C ... +85 °C (T5)
Ambient temperature	-76 °F ... +158 °F (T6) -76 °F ... +185 °F (T5)
Ambient temperature NEC®	-60 °C ... +75 °C (T6) -60 °C ... +90 °C (T5)
Ambient temperature NEC®	-76°F ... +167°F (T6) -76°F ... +194°F (T5)
Operating temperature	-60 °C ... +100 °C
Operating temperature	-76 °F ... +212 °F
Operating temperature NEC®	-60 °C ... +95 °C
Operating temperature NEC®	-76 °F ... +203 °F

Mechanical Data

Degree of protection (IP) (IEC 60529)	IP20
Enclosure material	Polyamide
Contact material	Silver-nickel
Silicone-free	Yes
Solid connection cross section	0.32 – 2.5 mm ²
Connection cross-section AWG single stranded	22 AWG ... 14 AWG
Finely stranded connection cross section	0.32 – 2.5 mm ²
Finely stranded connection cross-section AWG	22 AWG ... 14 AWG
Connection cross-section, finely stranded with core end sleeve	0.32 – 2.5 mm ²
Connection cross-section AWG finely stranded with core end sleeve	22 AWG - 14 AWG
Number of NOs	1
Contacts	1 NO
Packaging unit	1
Weight	90 g

Mounting / Installation

Tightening torque	1.2 N · m
Tightening torque lbf in	10.62 lbf in
Connection type	Screw terminal

Technical Drawings – Subject to Alterations

13
14
NO

Control and signalling devices

Contact element for front installation



Ex e

8082C3-21-2-0 Art. No. 315696

Dimensional Drawings (All Dimensions in mm [inches]) – Subject to Alterations

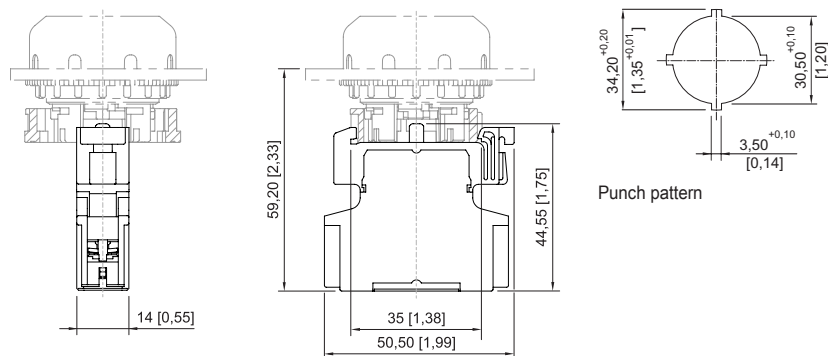

Contact element for front installation

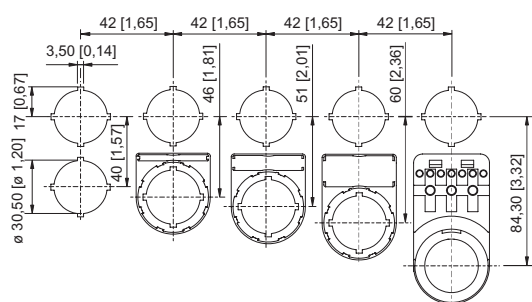

Cut-out with/without additional designation plate

Accessories

Pushbutton BG001



Ø 39 mm
Black
Designation plate: Black, blank disc without text
Front panel mounting
Silicone-free: Yes

Art. No.

223691

Ø 39 mm
Black
Designation plate: Black, blank disc without text
Front panel mounting
Silicone-free: No

223692

Mushroom pushbutton, black BG003



Ø 39 mm
Black
Designation plate: Black, blank disc without text
Front panel mounting
Silicone-free: Yes

Art. No.

244563

Ø 39 mm
Black
Designation plate: Black, blank disc without text
Front panel mounting
Silicone-free: No

244564

Control and signalling devices

Contact element for front installation



Ex e

8082C3-21-2-0 Art. No. 315696

Mushroom pushbutton, red

		Art. No.
	Ø 39 mm Red/black Designation plate: Red, blank disc without text Front panel mounting Silicone-free: Yes	244565
	Ø 39 mm Red/black Designation plate: Red, blank disc without text Front panel mounting Silicone-free: No	244566

Mushroom stay-put button with key lock

		Art. No.
	Ø 39 mm Red/black Closing: MS1 Front panel mounting Silicone-free: Yes	223695
	Ø 39 mm Red/black Closing: MS1 Front panel mounting Silicone-free: No	223696
	Ø 39 mm Red/black Closing: MS2 Front panel mounting Silicone-free: Yes	270409
	Ø 39 mm Red/black Closing: MS2 Front panel mounting Silicone-free: No	270412
	Ø 39 mm Red/black Closing: MS3 Front panel mounting Silicone-free: Yes	270410
	Ø 39 mm Red/black Closing: MS3 Front panel mounting Silicone-free: No	270413
	Ø 39 mm Red/black Closing: MS4 Front panel mounting Silicone-free: Yes	270411
	Ø 39 mm Red/black Closing: MS4 Front panel mounting Silicone-free: No	270414

Control and signalling devices

Contact element for front installation



Ex e

8082C3-21-2-0 Art. No. 315696

Key-operated switch actuator

		Art. No.
	<p>Ø 39 mm Black Closing: MS1 Number of switching positions: 2 Front panel mounting Switching function: Latching / Latching Silicone-free: No</p>	244574
	<p>Ø 39 mm Black Closing: MS1 Number of switching positions: 3 Front panel mounting Switching function: Latching / Latching / Latching Silicone-free: No</p>	244633

Control and signalling devices

Contact element for front installation



Ex e

8082C3-21-2-0 Art. No. 315696

Key-operated switch actuator

BG008

	Art. No.
 <p> Ø 39 mm Black Closing: MS1 Number of switching positions: 2 Front panel mounting Switching function: Latching / Latching Silicone-free: Yes </p>	244573
<p> Ø 39 mm Black Closing: MS2 Number of switching positions: 2 Front panel mounting Switching function: Latching / Latching Silicone-free: Yes </p>	272935
<p> Ø 39 mm Black Closing: MS2 Number of switching positions: 2 Front panel mounting Switching function: Latching / Latching Silicone-free: No </p>	270418
<p> Ø 39 mm Black Closing: MS3 Number of switching positions: 2 Front panel mounting Switching function: Latching / Latching Silicone-free: Yes </p>	274089
<p> Ø 39 mm Black Closing: MS3 Number of switching positions: 2 Front panel mounting Switching function: Latching / Latching Silicone-free: No </p>	270419
<p> Ø 39 mm Black Closing: MS4 Number of switching positions: 2 Front panel mounting Switching function: Latching / Latching Silicone-free: Yes </p>	272936
<p> Ø 39 mm Black Closing: MS4 Number of switching positions: 2 Front panel mounting Switching function: Latching / Latching Silicone-free: No </p>	270420

Control and signalling devices

Contact element for front installation



Ex e

8082C3-21-2-0 Art. No. 315696

Key-operated switch actuator

BG008

	Art. No.
 <p> Ø 39 mm Black Closing: MS1 Number of switching positions: 3 Front panel mounting Switching function: Latching / Latching / Latching Silicone-free: Yes </p>	244632
<p> Ø 39 mm Black Closing: MS2 Number of switching positions: 3 Front panel mounting Switching function: Latching / Latching / Latching Silicone-free: Yes </p>	274090
<p> Ø 39 mm Black Closing: MS2 Number of switching positions: 3 Front panel mounting Switching function: Latching / Latching / Latching Silicone-free: No </p>	270421
<p> Ø 39 mm Black Closing: MS3 Number of switching positions: 3 Front panel mounting Switching function: Latching / Latching / Latching Silicone-free: Yes </p>	274091
<p> Ø 39 mm Black Closing: MS3 Number of switching positions: 3 Front panel mounting Switching function: Latching / Latching / Latching Silicone-free: No </p>	270422
<p> Ø 39 mm Black Closing: MS4 Number of switching positions: 3 Front panel mounting Switching function: Latching / Latching / Latching Silicone-free: Yes </p>	274092
<p> Ø 39 mm Black Closing: MS4 Number of switching positions: 3 Front panel mounting Switching function: Latching / Latching / Latching Silicone-free: No </p>	270423

Control and signalling devices

Contact element for front installation



Ex e

8082C3-21-2-0 Art. No. 315696

Mushroom stay-put button with key lock, EM-STOP

		Art. No.
	Ø 39 mm Yellow/red Designation plate: With yellow backing plate Closing: MS1 Front panel mounting Silicone-free: Yes	223693
	Ø 39 mm Yellow/red Designation plate: With yellow backing plate Closing: MS1 Front panel mounting Silicone-free: No	223694

Mushroom stay-put button with key lock, EM-STOPY

		Art. No.
	Ø 39 mm Yellow/red Designation plate: With yellow backing plate Closing: MS2 Front panel mounting Silicone-free: Yes	274099

Mushroom stay-put button with key lock, EM-STOP

		Art. No.
	Ø 39 mm Yellow/red Designation plate: With yellow backing plate Closing: MS2 Front panel mounting Silicone-free: No	270415
	Ø 39 mm Yellow/red Designation plate: With yellow backing plate Closing: MS3 Front panel mounting Silicone-free: Yes	274100
	Ø 39 mm Yellow/red Designation plate: With yellow backing plate Closing: MS3 Front panel mounting Silicone-free: No	270416
	Ø 39 mm Yellow/red Designation plate: With yellow backing plate Closing: MS4 Front panel mounting Silicone-free: Yes	274101
	Ø 39 mm Yellow/red Designation plate: With yellow backing plate Closing: MS4 Front panel mounting Silicone-free: No	270417

Control and signalling devices

Contact element for front installation



Ex e

8082C3-21-2-0 Art. No. 315696

Mushroom stay-put button EM-STOP

		Art. No.
	Ø 39 mm Yellow/red Designation plate: With yellow backing plate Front panel mounting Silicone-free: Yes	223697
	Ø 39 mm Yellow/red Designation plate: With yellow backing plate Front panel mounting Silicone-free: No	223698

Mushroom stay-put button, black

		Art. No.
	Ø 39 mm Black Front panel mounting Silicone-free: Yes	223699
	Ø 39 mm Black Front panel mounting Silicone-free: No	223700

Mushroom pushbutton, 55 mm, red

		Art. No.
	Ø 55 mm Black/red Designation plate: Red, blank disc without text Front panel mounting Silicone-free: Yes	244634
	Ø 55 mm Black/red Designation plate: Red, blank disc without text Front panel mounting Silicone-free: No	244635

Mushroom stay-put button, 55 mm, EM-STOP

		Art. No.
	Ø 55 mm Yellow/red Designation plate: With yellow backing plate Front panel mounting Silicone-free: Yes	244636

Mushroom stay-put button 55 mm EM-STOP

		Art. No.
	Ø 55 mm Yellow/red Designation plate: With yellow backing plate Front panel mounting Silicone-free: No	244637

Control and signalling devices

Contact element for front installation



Ex e

8082C3-21-2-0 Art. No. 315696

Twin pushbutton

		Art. No.
	Black Front panel mounting Silicone-free: Yes	244638
	Black Front panel mounting Silicone-free: No	244639

Mushroom pushbutton, 55 mm, black

		Art. No.
	Ø 55 mm Black Designation plate: Black, blank disc without text Front panel mounting Silicone-free: Yes	244642
	Ø 55 mm Black Designation plate: Black, blank disc without text Front panel mounting Silicone-free: No	244643

Small rotary actuator, not lockable

		Art. No.
	Ø 39 mm Black Designation plate: 0/OFF - I/ON Number of switching positions: 2 Lockable in: Not padlockable Front panel mounting Switching function: Latching / Latching Silicone-free: Yes	244646

Small rotary actuator, not lockable

		Art. No.
	Ø 39 mm Black Designation plate: 0/OFF - I/ON Number of switching positions: 2 Lockable in: Not padlockable Front panel mounting Switching function: Latching / Latching Silicone-free: No	244647

Control and signalling devices

Contact element for front installation





Ex e

8082C3-21-2-0 Art. No. 315696

Small rotary actuator, not lockable

		Art. No.
	Ø 39 mm Black Designation plate: I - 0 - II Number of switching positions: 3 Lockable in: Not padlockable Front panel mounting Switching function: Latching / Latching / Latching Silicone-free: Yes	244648
	Ø 39 mm Black Designation plate: I - 0 - II Number of switching positions: 3 Lockable in: Not padlockable Front panel mounting Switching function: Latching / Latching / Latching Silicone-free: No	244649

Rotary actuator, small, lockable

		Art. No.
	Ø 39 mm Black Designation plate: 0/OFF - I/ON Number of switching positions: 2 Lockable in: One pos. with one lock Front panel mounting Switching function: Latching / Latching Silicone-free: Yes	244650
	Ø 39 mm Black Designation plate: 0/OFF - I/ON Number of switching positions: 2 Lockable in: One pos. with one lock Front panel mounting Switching function: Latching / Latching Silicone-free: No	244651
	Ø 39 mm Black Designation plate: I - 0 - II Number of switching positions: 3 Lockable in: One pos. with one lock Front panel mounting Switching function: Latching / Latching / Latching Silicone-free: Yes	244652
	Ø 39 mm Black Designation plate: I - 0 - II Number of switching positions: 3 Lockable in: One pos. with one lock Front panel mounting Switching function: Latching / Latching / Latching Silicone-free: No	244653

Control and signalling devices

Contact element for front installation



Ex e

8082C3-21-2-0 Art. No. 315696

Illuminated pushbutton (spring return)

		Art. No.
	Ø 39 mm Black Front panel mounting All colours Silicone-free: Yes	244654
	Ø 39 mm Black Front panel mounting All colours Silicone-free: No	244655

We reserve the right to make alterations to the technical data, dimensions, weights, designs and products available without notice. The illustrations cannot be considered binding.