

Lighting

Linear luminaire With LED

GRP

6402/4128-6100-152-1110-11-8500-C2229 Art. No. 267037

STAHL



- State-of-the-art LED technology with high luminous efficacy and long service life
- Extremely high luminaire efficacy
- Luminous flux after 100,000 h still 90% of the starting luminous flux
- Optionally with DALI for controlling and monitoring the luminaire
- Optionally with address modules for directly actuation of a common battery system

MY R. STAHL 6402C



The linear luminaire with Series 6402/4 LED is ideal for lighting surfaces at a mounting height of up to 10 m. It can also be used to illuminate equipment and objects, both inside and outside. The pole mounting sleeve accessory can be used to easily mount the luminaire on poles. Optionally, the luminaire can be equipped with an address module. It can be used to control and monitor the luminaire for the common battery systems.

Technical Data

Explosion Protection

Ex version	Yes
Application range (zones)	2, 21, 22
IECEX gas certificate	IECEX IBE 14.0080
IECEX gas certificate	IECEX IBE 14.0080
IECEX gas explosion protection	Ex ec IIC T4 Gc
IECEX dust certificate	IECEX IBE 14.0080
IECEX dust explosion protection	Ex tb op is / tc IIIC T100 °C Db
ATEX gas certificate	IBExU 14 ATEX 1292
ATEX gas certificate	IBExU 14 ATEX 1292
ATEX gas explosion protection	⊕ II 3 G Ex ec IIC T4 Gc
ATEX dust certificate	IBExU 14 ATEX 1292
ATEX dust explosion protection	⊕ II 2 D Ex tb op is / tc IIIC T100 °C Db
Certificates and approvals	ATEX IECEX UKEX
Certificates	ATEX (IBE), IECEX (IBE)
Declaration of Conformity	ATEX (EUK), Declaration of Conformity (AUS)

Electrical Data

Rated operational voltage AC	100 ... 240 V
Rated operational voltage DC	110 ... 250 V
Frequency range	50 – 60Hz

Lighting Data

Number of lamps	1
Lamp wattage	22 W
Lamp	LED
Light colour	5000 K – neutral white

Lighting

Linear luminaire With LED

GRP

6402/4128-6100-152-1110-11-8500-C2229 Art. No. 267037



Lighting Data

Light distribution	120°x120° with diffusing glass
Luminaire efficacy	132 lm/W
Luminous flux	2910 lm
Colour rendering	≥ 80
Colour temperature	5000 K

Ambient Conditions

Ambient temperature	-40 °C ... 55 °C (T100 °C) Note: Through wiring Max. 3x16 A -40 °C ... 60 °C (T100 °C) Note: Through wiring 2 Max. 3x10 A
---------------------	--

Mechanical Data

Version	Special version
IP degree of protection (IEC 60598)	IP66/IP67
Enclosure material	Polyester resin, Glass fibre reinforced
Enclosure colour	Light grey (RAL 7035)
Diffuser	With diffuser
Sealing material	Silicone
Silicone-free content	Contains silicone
Translucent cover material	Polycarbonate
Installed terminal strip	PE + N + L1 + L2 + L3
Max. solid connection terminals	6 mm ²
Max. finely stranded connection terminals	4 mm ²
Type of connection cable	Finely stranded Solid
Size	2
Width	184 mm
Height	125 mm
Length	700 mm
Impact strength (IEC 62262)	IK10
Weight	3.2 kg
Weight	7.05 lb
Disconnection of the luminaire	No

Components

Threaded plate	2x plastic
Ballast	VG Luxtronic 40 W 300 mA
Through wiring	With 5 conductors 2.5 mm ²
Drilled holes	3 x M25
Cable glands and entries	2 x M25 Ø 7 ...
Material cable gland	Polyamide, black
Stopping plugs	2 x M25 x 1.5
Stopping plug material	Polyamide, black
Accessories	Provided

Light Distribution Curves

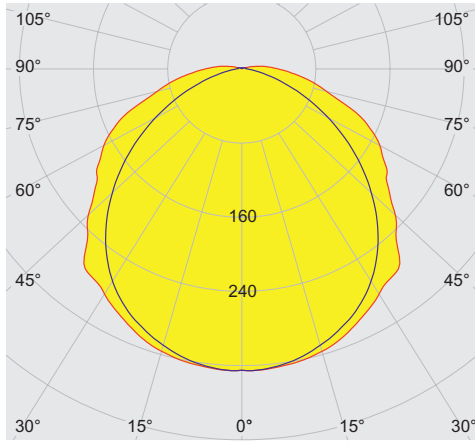

cd/klm 100%
 — C0 - C180 — C90 - C270
 typical with diffuser, clear translucent cover

Dimensional Drawings (All Dimensions in mm [inches]) – Subject to Alterations

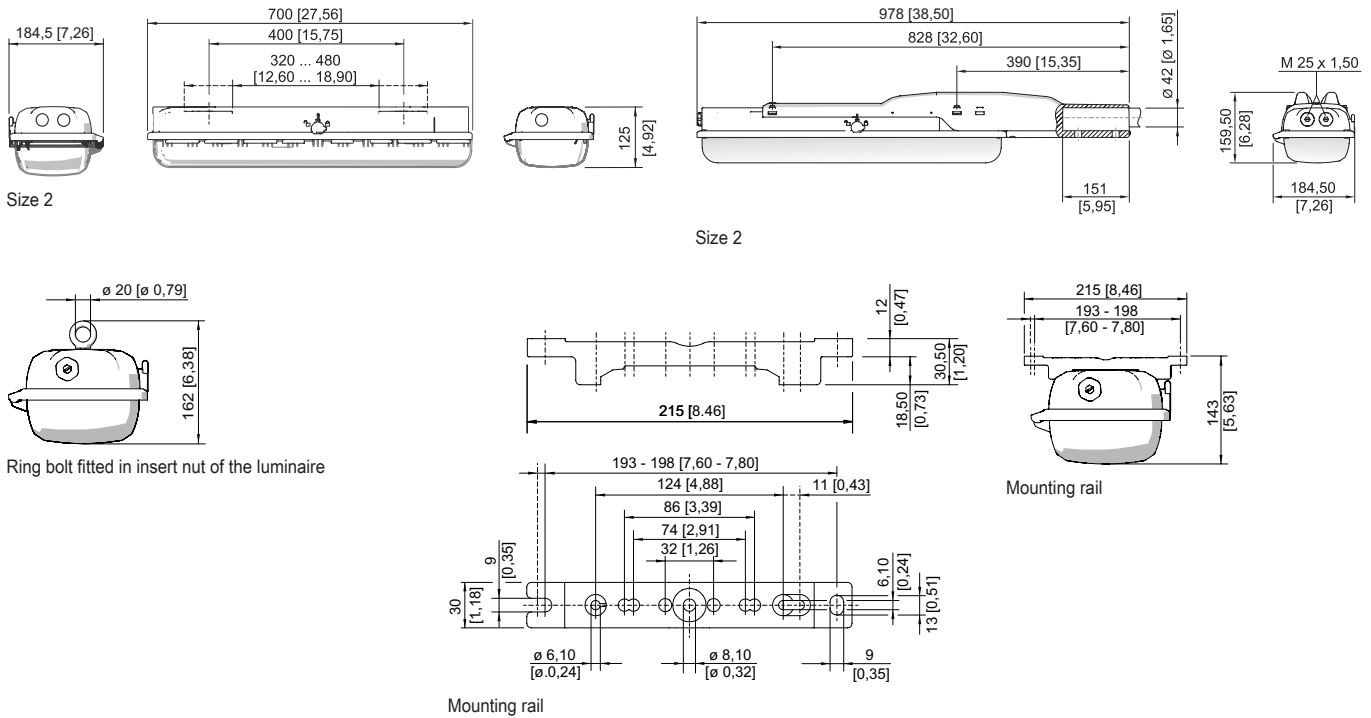

Lighting

Linear luminaire With LED

GRP

6402/4128-6100-152-1110-11-8500-C2229 Art. No. 267037



Pipe clamp fitted in mounting rail



Mounting bracket fitted in mounting rail

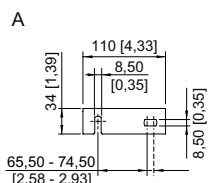

Wall mounting bracket fitted in mounting rail

Accessories

Box spanner

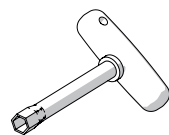

M8 / A/F 13;
For actuating the central lock

Art. No.

222430

Breather

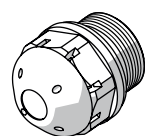

Thread: M25 x 1.5 (20 pieces); without jam nut

Art. No.

285780

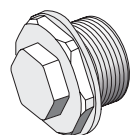

Thread: M25 x 1.5 (1 piece); for installation in light fittings; made from stainless steel; without jam nut

Art. No.

296608

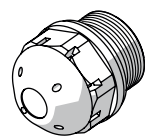

M25 x 1.5 in order to avoid condensate formation

Art. No.

115738

Ceiling and wall mounting bracket

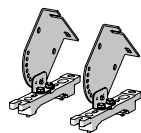

mounted on a mounting rail for a variable mounting distance; Material: stainless steel; Lamp can be swiveled in steps of 15°; 1 pair

Art. No.

222827

Holder for translucent cover

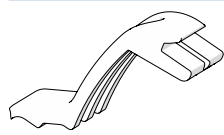

The fall prevention system for the light fitting cover prevents the light fitting cover from falling accidentally when the light fitting is opened.

Art. No.

226791

Lighting

Linear luminaire With LED

GRP

6402/4128-6100-152-1110-11-8500-C2229 Art. No. 267037

STAHL

Mounting bracket

Art. No.



mounting clamp mounted on a mounting rail for a variable mounting distance; 1 pair

222456

Mounting rail

Art. No.



for a variable mounting distance; 1 pair

222826

Pipe clamp

Art. No.



R 1 1/2"; with mounting rail for a variable mounting distance; material: stainless steel; 1 pair

222459

R 1 1/4"; with mounting rail for a variable mounting distance; Material: stainless steel; 1 pair

222458

R 2"; with mounting rail for a variable mounting distance; Material: stainless steel; 1 pair

222460

Pole mounting sleeve

Art. No.



for the subsequent mounting on lights size 2 and size 4, completely with assembly parts (for pipe diameter 42 mm)

227512

Protection against accidental contact

Art. No.



The protection against accidental contact prevents maintenance technicians and electrical installers from accidentally touching conductive parts. The degree of protection is increased to IP20 when the protection against accidental contact is used.

283153

Ring bolt

Art. No.



M8, direct mounting in insert nuts; 1 pair

115736

Spare Parts

Cover

Art. No.

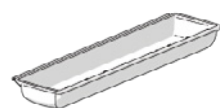

for luminaire size 2

222427

Reflector Plate

Art. No.



Spare part for 6402 or upgrade 6401 size 2, colour temperature 5000 K

270816

We reserve the right to make alterations to the technical data, dimensions, weights, designs and products available without notice. The illustrations cannot be considered binding.