

Control and signalling devices

Control devices for panel mounting

Ex e

8003/131-001 Art. No. 269767



PanSiG



- Flexible configuration thanks to pushbutton, mushroom push-button, mushroom stay-put button, mushroom stay-put button with key lock, key-operated button and key-operated switch
- Easy to install using a single hole
- Codable "latching", "spring return" and "key not removable" functions
- Spring clamp terminals with connection chamber

MY R. STAHL 8003B



R. STAHL Series 8003 switches and control buttons for panel mounting take on various switching functions in latching and spring return positions up to 6 A, which can be subsequently recoded. They are fully certified, explosion-protected equipment with an Ex e connection chamber. With the patented mounting mechanism, panel mounting with drilled holes or openings of 30.5 mm is quick and easy.

Compatible actuators are available for a comprehensive range of applications.

Technical Data

Explosion Protection

Area of application	European Union (ATEX) IECEX CCC
Application range (zones)	1, 2, 21, 22
IECEX gas certificate	IECEX PTB 06.0065X
IECEX gas explosion protection	Ex db eb IIC T6 Gb
IECEX dust certificate	IECEX PTB 06.0065X
IECEX dust explosion protection	Ex tb IIIC T80 °C Db
ATEX gas certificate	PTB 02 ATEX 1057 X
ATEX gas explosion protection	⊕ II 2 G Ex db eb IIC T6 Gb
ATEX dust certificate	PTB 02 ATEX 1057 X
ATEX dust explosion protection	⊕ II 2 D Ex tb IIIC T80 °C Db
Certificates	ATEX (PTB), China (CQST), IECEX (PTB), Korea (KGS)
Declaration of Conformity	ATEX (EUK), China (CCC), Declaration of Conformity (ATEX)
Notes	Product label may vary. Series devices are labelled with ATEX and IECEX.

Electrical Data

Rated operational voltage AC	500 V
Rated operational current	6 A
Switching capacity AC-12	500 V / 6 A / max. 3000 VA
Switching capacity AC-15	400 V / 6 A / max. 1250 VA
Switching capacity DC-13	110 V / 1 A / max. 110 W
Switching capacity DC-13<SoftReturn/>2 contact elements in series	60 V/6 A

Ambient Conditions

Ambient temperature	-20 °C ... +60 °C
Ambient temperature	-4 °F ... +140 °F

Control and signalling devices

Control devices for panel mounting



Ex e

8003/131-001 Art. No. 269767

Mechanical Data

Degree of protection (IP) (IEC 60529)	Reverse side IP65, front side IP66
Enclosure material	Polyamide
Contact material	Silver-nickel
Silicone-free	Yes
Number of NOs	2
Connection cross-section	0.75 ... 1.5 mm ²
Connection cross-section AWG	18 AWG ... 12 AWG
Depth of cut-out	130 mm
Mounting depth in inches	5.12 in
Service life, min.	10 ⁵ operating cycles
Weight	140 g
Weight	0.31 lb

Mounting / Installation

Tightening torque	3 Nm
Tightening torque lbf in	26.55 lbf in

Components

Actuator	Pushbutton
Entry 1	8161/7-M16-0902
Entry 1 type	Polyamide cable gland, black

Technical Drawings – Subject to Alterations

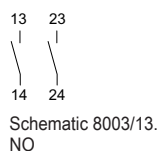

Dimensional Drawings (All Dimensions in mm [inches]) – Subject to Alterations

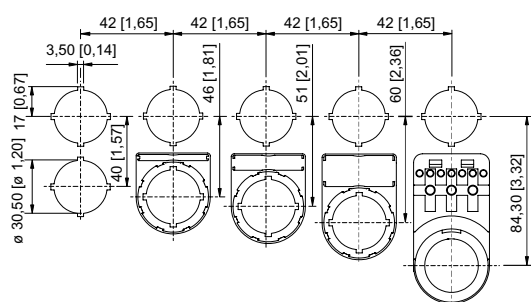
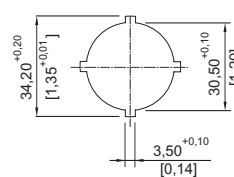
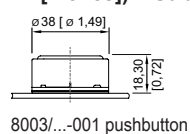
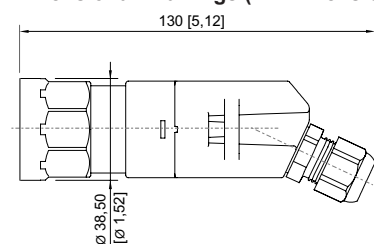

Cut-out with/without additional designation plate

Accessories

Control and signalling devices

Control devices for panel mounting



Ex e

8003/131-001 Art. No. 269767



Actuators

Art. No.

	Pushbutton	155525
--	------------	--------

Locking devices



Art. No.

	8602A0754 for actuated pushbutton/selector switch BG001, BG005	155402
	8602A0755 for not actuated pushbutton/selector switch BG001, BG005	155431

Spare Parts

Label holder

Art. No.

	Label holder, size 1, without insert disc Labelling: 1-line can be installed in dia. 30.5 mm drilled holes for actuators	155632
	Label holder, size 2, without insert disc Labelling: 1- or 2-line can be installed in dia. 30.5 mm drilled holes for actuators	155687

Locking devices

Art. No.

	8602A0753 H24 for not actuated pushbutton/selector switch BG001, BG005	155372
--	---	--------



Label holder

Art. No.

	Label holder, size 3, without insert disc Labelling: 1-, 2- or 3-line can be installed in dia. 30.5 mm drilled holes for actuators	155844
--	--	--------

Designation plates for pushbuttons and selector switches

Art. No.

	Colour: White Text: START	155889
	Colour: Blue Text: RESET	155894



Control and signalling devices

Control devices for panel mounting



Ex e

8003/131-001 Art. No. 269767

	Colour: Green Text: START	155721
	Colour: Black Text: Ab	155886
	Colour: Black Text: Auf	155883

Protective collar

Art. No.

	8602A0751 metal for pushbutton/selector switch/mushroom stay-put button with key lock/mushroom stay-put button/mushroom pushbutton dia. 39 BG001, BG003, BG005, BG008, BG009, BG010, BG012	155326
--	--	--------

Designation plates for pushbuttons and selector switches

Art. No.

	Colour: Black Symbol: Arrow	155749
	Colour: Black Symbol: Arrow	155761
	Colour: Black Text: Links	155827
	Colour: Black Text: Rechts	155837
	Colour: Black Text: Open	155868
	Colour: Black Text: CLOSE	155878
	Colour: Black Text: Zu	155874



Control and signalling devices

Control devices for panel mounting



Ex e

8003/131-001 Art. No. 269767

	Colour: Red Text: OFF	155654
	Colour: Green Text: ON	155671
	Colour: Red Text: AUS	155634

Insert discs for label holder		Art. No.
	One-line Plain Material: PVC Colour: White Self-adhesive	238271

Designation plates for pushbuttons and selector switches		Art. No.
	Colour: Black Text: AUS	155806

Insert discs for label holder		Art. No.
	Two-line Plain Material: PVC Colour: White Self-adhesive	238272

Designation plates for pushbuttons and selector switches		Art. No.
	Colour: Black Text: EIN	155862

Insert discs for label holder		Art. No.
	Three-line Plain Material: PVC Colour: White Self-adhesive	238273

Designation plates for pushbuttons and selector switches		Art. No.
	Colour: Black Text: STOP	155795

Control and signalling devices

Control devices for panel mounting



Ex e

8003/131-001 Art. No. 269767







Closing part

Art. No.

	8602C3-733-B for closing unused holes in cover, dia. 30.5 mm, NBR	244306
	8602C3-733-S for closing unused holes in cover, dia. 30.5 mm, silicone	244307

Designation plates for pushbuttons and selector switches

Art. No.

	Colour: Black Text: I	155846
	Colour: Green Text: I	155689
	Colour: White Text: I	155892
	Colour: Black Text: II	155854
	Colour: Green Text: II	155706
	Colour: Red Text: O	155596
	Colour: Black Text: O	155783
	Colour: Black Text: I O	155771
	Colour: Blue Blank disc without text	155911
	Colour: Yellow Blank disc without text	155914





Control and signalling devices

Control devices for panel mounting



Ex e

8003/131-001 Art. No. 269767

	Colour: Red Blank disc without text	155897
	Colour: Green Blank disc without text	155901
	Colour: White Blank disc without text	155908
	Colour: Black Blank disc without text	155905

We reserve the right to make alterations to the technical data, dimensions, weights, designs and products available without notice. The illustrations cannot be considered binding.