

# Lighting

## Linear luminaire With LED

### GRP industrial design

L402/4348-6100-152-2220-22-8500 Art. No. 271365



- Highly resistant industrial design
- Linear luminaire with long-life, efficient LED technology (up to 138 lm/W)
- Lightweight yet extremely robust, with an impact strength rating of IK10

### MY R. STAHL L402A

The EXLUX L402/4 luminaire is designed for industrial use and can be fitted to the ceiling, a pole, or alternatively, it can be suspended. A bright light for not much energy is what you get with this efficient LED technology, which offers the added benefit of increased service life – this can be as much as 100,000 hours. The plastic enclosure is easily to open by a central lock.

## Technical Data

Explosion Protection	
Ex version	Industrial design
Electrical Data	
Rated operational voltage AC	100 ... 240 V
Rated operational voltage DC	200 ... 250 V
Frequency range	50 – 60Hz
Lighting Data	
Number of lamps	1
Lamp wattage	42 W
Lamp	LED
Light colour	5000 K – neutral white
Light distribution	120°x120° with diffusing glass
Luminaire efficacy	138 lm/W
Luminous flux	5810 lm
Colour rendering	≥ 80
Colour temperature	5000 K
Ambient Conditions	
Ambient temperature	-40 °C ... 55 °C Note: Through wiring Max. 3x16 A -40 °C ... 60 °C Note: Through wiring 2 Max. 3x10 A
Note	Through wiring max. 3x16 A Ambient temperature °C -40 °C ... +55 °C Through wiring 2 max. 3x10 A Ambient temperature °C 2 -40 ... +60 °C
Mechanical Data	
Version	Standard
IP degree of protection (IEC 60598)	IP66/IP67
Class	I (with inner PE connection)
Enclosure material	Polyester resin, Glass fibre reinforced

# Lighting

## Linear luminaire With LED

### GRP industrial design

L402/4348-6100-152-2220-22-8500 Art. No. 271365



#### Mechanical Data

Enclosure colour	Light grey (RAL 7035)
Diffuser	With diffuser
Sealing material	Silicone
Silicone-free content	Contains silicone
Translucent cover material	Polycarbonate
Installed terminal strip	PE + N + L1 + L2 + L3
Max. solid connection terminals	6 mm <sup>2</sup>
Max. finely stranded connection terminals	4 mm <sup>2</sup>
Type of connection cable	Finely stranded Solid
Size	4
Width	184 mm
Height	125 mm
Length	1310 mm
Impact strength (IEC 62262)	IK10
Weight	5.7 kg
Weight	12.57 lb
Disconnection of the luminaire	No

#### Components

Threaded plate	2x SS430 stainless steel
Ballast	VG Luxtronic 40 W 300 mA
Through wiring	With 5 conductors 2.5 mm <sup>2</sup>
Drilled holes	3 x M20
Cable glands and entries	can be ordered as an accessory
Stopping plugs	Can be ordered as accessories
Accessories	without

#### Light Distribution Curves

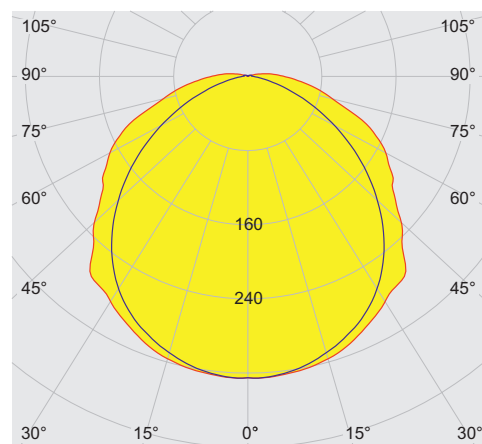

cd/klm 100%  
— C0 - C180 — C90 - C270  
typical with diffuser, clear translucent cover

# Lighting

Linear luminaire With LED

GRP industrial design

L402/4348-6100-152-2220-22-8500 Art. No. 271365



## Dimensional Drawings (All Dimensions in mm [inches]) – Subject to Alterations

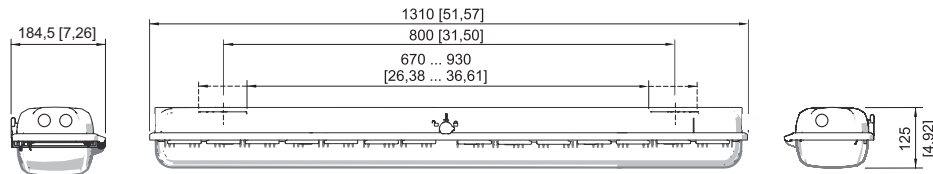

Size 4

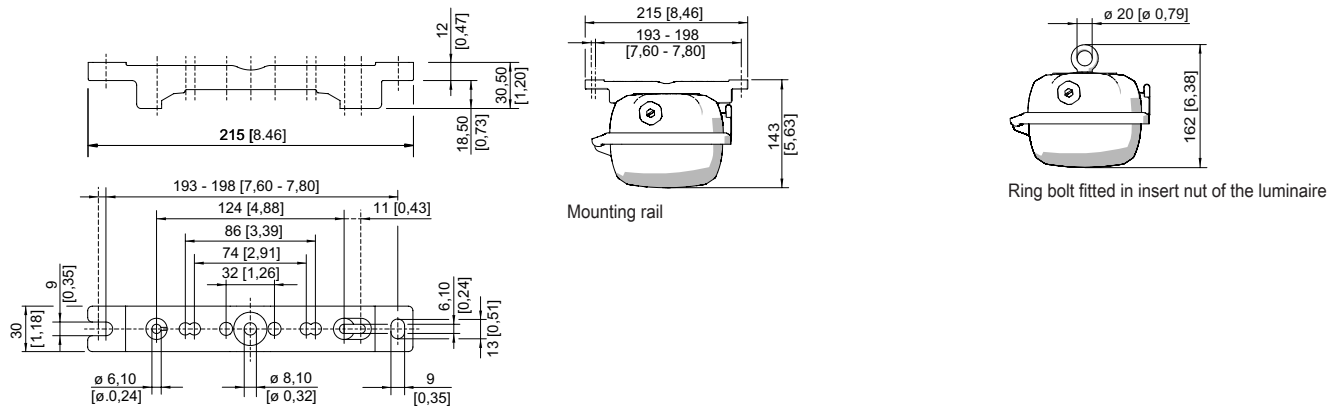

Mounting rail

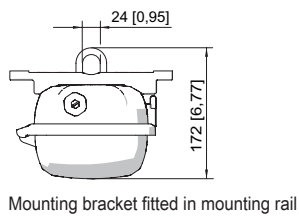

Mounting bracket fitted in mounting rail

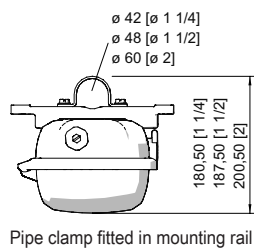

Pipe clamp fitted in mounting rail

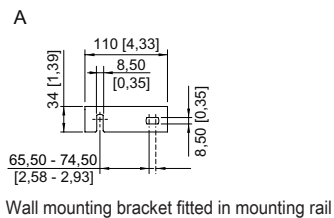
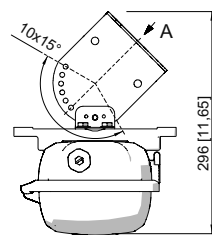

Wall mounting bracket fitted in mounting rail

## Accessories

### Box spanner

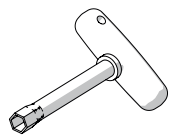

M8 / A/F 13;  
For actuating the central lock

Art. No.

222430

### Breather

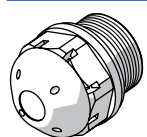

Thread: M25 x 1.5 (20 pieces); without jam nut

Art. No.

285780



# Lighting

Linear luminaire With LED

GRP industrial design

L402/4348-6100-152-2220-22-8500 Art. No. 271365

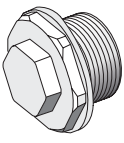
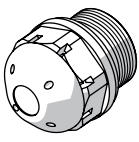
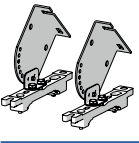
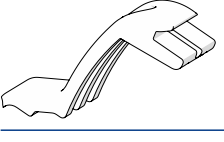
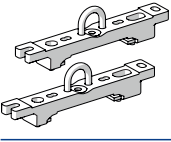
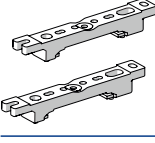
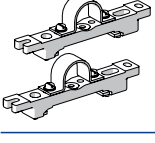

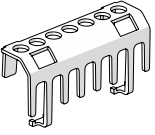
	<p>Thread: M25 x 1.5 (1 piece); for installation in light fittings; made from stainless steel; without jam nut</p>	<p>296608</p>
	<p>M25 x 1.5 in order to avoid condensate formation</p>	<p>115738</p>
<p><b>Ceiling and wall mounting bracket</b></p>		<p><b>Art. No.</b></p>
	<p>mounted on a mounting rail for a variable mounting distance; Material: stainless steel; Lamp can be swiveled in steps of 15°; 1 pair</p>	<p>222827</p>
<p><b>Holder for translucent cover</b></p>		<p><b>Art. No.</b></p>
	<p>The fall prevention system for the light fitting cover prevents the light fitting cover from falling accidentally when the light fitting is opened.</p>	<p>226791</p>
<p><b>Mounting bracket</b></p>		<p><b>Art. No.</b></p>
	<p>mounting clamp mounted on a mounting rail for a variable mounting distance; 1 pair</p>	<p>222456</p>
<p><b>Mounting rail</b></p>		<p><b>Art. No.</b></p>
	<p>for a variable mounting distance; 1 pair</p>	<p>222826</p>
<p><b>Pipe clamp</b></p>		<p><b>Art. No.</b></p>
	<p>R 1 1/2"; with mounting rail for a variable mounting distance; material: stainless steel; 1 pair</p>	<p>222459</p>
	<p>R 1 1/4"; with mounting rail for a variable mounting distance; Material: stainless steel; 1 pair</p>	<p>222458</p>
	<p>R 2"; with mounting rail for a variable mounting distance; Material: stainless steel; 1 pair</p>	<p>222460</p>
<p><b>Pole mounting sleeve</b></p>		<p><b>Art. No.</b></p>
	<p>for the subsequent mounting on lights size 2 and size 4, completely with assembly parts (for pipe diameter 42 mm)</p>	<p>227512</p>
<p><b>Protection against accidental contact</b></p>		<p><b>Art. No.</b></p>
	<p>The protection against accidental contact prevents maintenance technicians and electrical installers from accidentally touching conductive parts. The degree of protection is increased to IP20 when the protection against accidental contact is used.</p>	<p>283153</p>

## Lighting

Linear luminaire With LED

GRP industrial design

L402/4348-6100-152-2220-22-8500 Art. No. 271365



### Ring bolt

### Art. No.



M8, direct mounting in insert nuts; 1 pair

115736

### Spare Parts

### Cover

### Art. No.

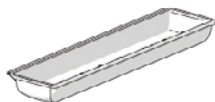

for luminaire size 4

222428

We reserve the right to make alterations to the technical data, dimensions, weights, designs and products available without notice. The illustrations cannot be considered binding.