

Contactors

80 A

8550/1-CT-GLS3-80-95-U2S-22 Art. No. 287708



- Reliable control of motors and other loads in motor starters and power distribution boards
- Reliable protection of motors in conjunction with the overload relay
- International approvals for worldwide use
- Ultimate flexibility thanks to wide-range coil voltages
- Large cable dia. range of the main terminals

MY R. STAHL 8550C



R. STAHL's Series 8550 contactor is a motor load contactor for use in motor starters up to 37 kW/50 hp at 400 or 480 V and in other power-based applications. It switches AC-3, AC-4, AC-5 and AC-6 loads just as reliably as AC-1 operating currents. Values are also available for DC-1, -3 and -5. With just three coil voltage ranges, control voltages of 20 to 280 volts are covered. Up to four auxiliary contacts are optionally available. Supplemented by the moulded case circuit breaker and overload relay also available in this series, motor starters up to 37 kW/50 hp at 400 or 480 V are available (other powers available on request).

Technical Data

Explosion Protection

Application range (zones)	1, 2
Application range (Zone) note	For use in Zone 21/22 when protected by Ex tb/tc enclosure
IECEX gas certificate	IECEX FMG 22.0005U
IECEX gas explosion protection	Ex db eb IIC Gb
ATEX gas certificate	FM 22 ATEX 0017 U
ATEX gas explosion protection	Ex II 2 G Ex db eb IIC Gb
FMus certificate	FM22US0011U
cFM certificate	FM22CA0006U
Marking FMus	Class I, Div. 2, Groups A,B,C,D; Class I, Zone 1, AEx db eb IIC Gb;
Marking cFM	Class I, Zone 1, Ex db eb IIC Gb; Class I, Div. 2, Groups A,B,C,D;
Certificates	ATEX (FM), Brazil (ULB), Canada (FM), IECEX (FM), USA (FM)

Electrical Data

Rated operational voltage	max. 690 V
Rated operational current	80 A
Rated actuating voltage	83 to 155 V AC/DC
Mechanical service life	10,000,000
Idle operating frequency	5000 1/h
Operating frequency AC-3	500 1/h
Main contacts	3-pole (3 NO)
Auxiliary contacts	4 (2 NO + 2 NC)
1st auxiliary function for AC rated voltage	-
1st auxiliary function voltage max. DC	-

Contactors

80 A

8550/1-CT-GLS3-80-95-U2S-22 Art. No. 287708

Electrical Data

1st auxiliary function for rated current max.	-
2nd auxiliary function voltage AC	-
2nd auxiliary function voltage max. DC	-
2nd auxiliary function for rated current max.	-

Ambient Conditions

Ambient temperature °C	-25 °C ... +60 °C
Ambient temperature °F	-13 °F ... +140 °F

Mechanical Data

Degree of protection (IP)	IP20
Enclosure material	Thermoplast
Connection cross-section	25 – 95 mm ²
Connection cross-section AWG	4 ... 4/0 AWG
Auxiliary contact connection cross section	0.75 ... 2.5 mm ²
Auxiliary contact connection cross section AWG	18 ... 14 AWG
Width	150 mm
Width, inches	5.91 in
Height	196 mm
Height in inches	7.72 in
Depth	336.6 mm
Depth in inches	13.25 in
Weight	9.26 lb

Mounting / Installation

Tightening torque	15 – 20 Nm
Tightening torque lbf in	132 to 177 lbf in
Tightening torque auxiliary contact	0.4 – 0.6 Nm
Tightening torque auxiliary contact lbf in	3.54 ... 5.31 lbf-in

Technical Drawings – Subject to Alterations

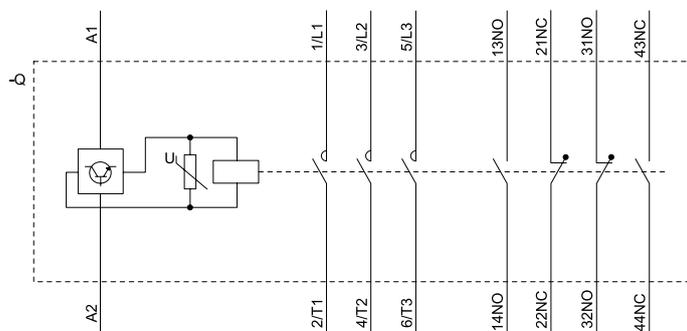

Circuit diagram of the device

Components for system solutions

Contactors

80 A

8550/1-CT-GLS3-80-95-U2S-22 Art. No. 287708



Dimensional Drawings (All Dimensions in mm [inches]) – Subject to Alterations

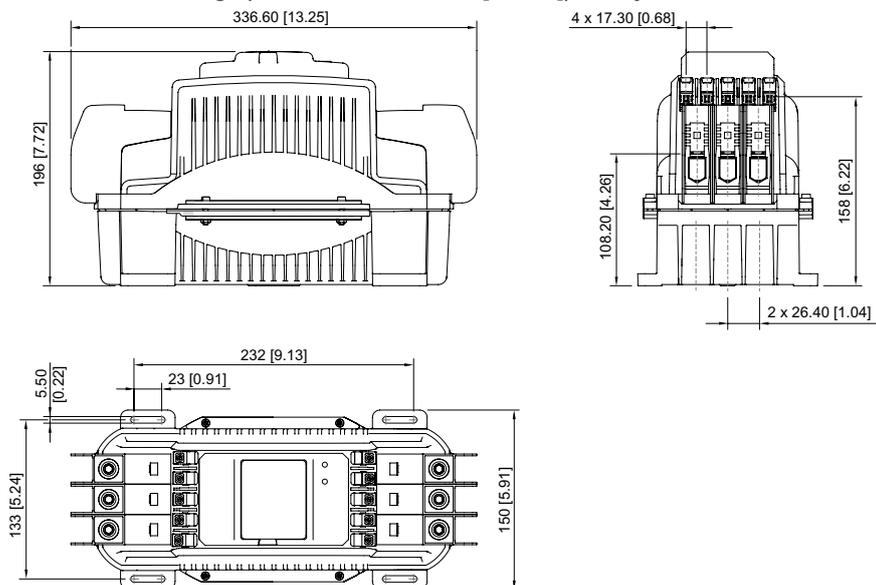

We reserve the right to make alterations to the technical data, dimensions, weights, designs and products available without notice. The illustrations cannot be considered binding.