

8166/11-07-NE Art. No. 139088



- Metal Ex e conduit hub
- Wide selection of NPT thread sizes
- Large temperature range of use
- Globally certified in accordance with IECEx, ATEX and cULus
- Integrated self-loosening protection thanks to threaded pin

MY R. STAHL 8166A



R. STAHL's Series 8166 conduit hubs are used to route permanently installed conduit systems with NPT thread into electrical equipment with the increased safety "e" type of protection or the protection by explosion "tb" type of protection, and are suitable for NEMA type 4X installation.

Technical Data

Explosion Protection

Area of application	USA Canada European Union (ATEX) IECEX
Application range (zones)	1, 2, 21, 22
IECEX gas certificate	IECEX PTB 06.0095 U
IECEX gas explosion protection	Ex eb IIC Gb
IECEX dust certificate	IECEX PTB 06.0095 U
IECEX dust explosion protection	Ex tb IIIC Db
ATEX gas certificate	PTB 00 ATEX 1114 U
ATEX gas explosion protection	⊕ II 2 G Ex eb IIC Gb
ATEX dust certificate	PTB 00 ATEX 1114 U
ATEX dust explosion protection	⊕ II 2 D Ex tb IIIC Db
Certificate ULus	E200949V1S2
Certificate cUL	E200949V1S2
Marking ULus	Class I, Zone 1 AEx e II Class I, Div. 2, Groups A,B,C,D Class II, Div. 2, Groups F,G Class III Type 3, 4, 4X
Marking cUL	Class I, Zone 1 Ex e II Class I, Div. 2, Groups A,B,C,D Class II, Div. 2, Groups F,G Class III Type 3, 4, 4X
Certificates	ATEX (PTB), Canada / USA (UL), Canada (UL), IECEX (PTB)

Electrical Data

Grounding terminal	Yes
--------------------	-----

Ambient Conditions

Ambient temperature °C	-30 °C ... +100 °C
------------------------	--------------------

8166/11-07-NE Art. No. 139088

Ambient Conditions

Ambient temperature °F -22 °F ... +212 °F

Mechanical Data

Version	NPT/NPT
Degree of protection (IP)	IP66
Degree of protection (IP) (IEC 60529)	IP66
Type (NEMA)	3, 4, 4X
Material	Zinc
Silicone-free	No
Outer diameter	93.98 mm
Outer diameter in inches	3.705 in
External thread	NPT2-1/2
Thread size	NPT2-1/2
Internal thread	NPT2-1/2
Weight	0.66 lb

Dimensional Drawings (All Dimensions in mm [inches]) – Subject to Alterations

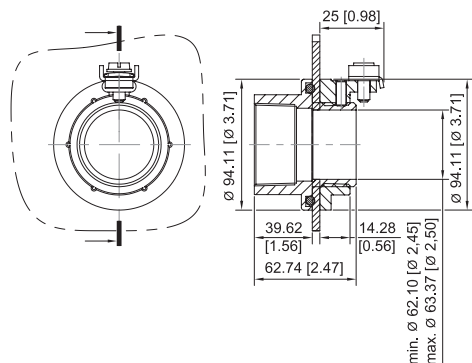

8166/11-07-NE

We reserve the right to make alterations to the technical data, dimensions, weights, designs and products available without notice. The illustrations cannot be considered binding.