

# Isolator Barriers

Binary output

Ex i field circuit

9175/20-12-11s Art. No. 160404



- Comprehensive portfolio to cater for all characteristics
- Two-channel variants reduce the amount of space required
- Can be used up to SIL 3 (IEC/EN 61508)
- For interface solenoid valves and LEDs

MY R. STAHL 9175A



9175 series binary outputs issue binary signals via one or two channels for the intrinsically safe operation of Ex i solenoid valves, indicator lamps or horns. The devices feature three-way galvanic separation. A wire-breakage and short-circuit monitoring system, which can be disconnected, directly monitors the state of the field circuit.

## Technical Data

Explosion Protection	
Application range (zones)	2
Ex interface zone	0, 1, 2, 20, 21, 22
IECEX gas certificate	IECEX BVS 10.0050 X
IECEX gas certificate	IECEX BVS 10.0050 X
IECEX gas explosion protection	Ex nA nC [ia Ga] IIC T4 Gc
IECEX dust certificate	IECEX BVS 10.0050 X
IECEX dust explosion protection	[Ex ia Da] IIIC
ATEX gas certificate	DMT 03 ATEX E 043 X
ATEX gas certificate	DMT 03 ATEX E 043 X
ATEX gas explosion protection	⊕ II 3 (1) G Ex nA nC [ia Ga] IIC T4 Gc
ATEX dust certificate	DMT 03 ATEX E 043 X
ATEX dust explosion protection	⊕ II (1) D [Ex ia Da] IIIC
FMus certificate	FM16US0122X
cFM certificate	FM16CA0067X
Marking cFMus	Class I, Div. 2, Groups A,B,C,D; Class I, Zone 2, Group IIC AIS Class I,II,III, Div. 1, Groups A,B,C,D,E,F,G; Class I, Zone 0, [AEx ia]/[Ex ia] IIC T4 Mounting vert. at Ta = 70°C , or horizontal Ta = 60°C See Doc. 91 756 01 31 1
cULus certificate	E81680V1S7
Marking cULus	prov. intr. safe circ. f.u.in Class I,II,III, Groups A,B,C,D,E,F,G; See Doc. 91 756 01 31 3
Certificates	ATEX (BVS), Brazil (ULB), Canada (FM), China (NEPSI), IECEX (BVS), Korea (KTL), SIL (exida), USA (FM), USA (UL)
Ship approval	CCS, EU RO MR (DNV)
Declaration of conformity	ATEX (EUK), China (CCC)

# Isolator Barriers

Binary output

Ex i field circuit

9175/20-12-11s Art. No. 160404



## Safety Data

Max. voltage $U_o/V_{oc}$	11.3 V	
Max. current $I_o$ (Ex ia)	75 mA	
Max. power $P_o$	210 mW	
Max. permissible external capacitance $C_o/C_a$ for IIC	1.79 $\mu$ F	
Max. permissible external inductance $L_o/L_a$ for IIC	6.3 mH	
Max. permissible external capacitance $C_o/C_a$ for IIB	12.1 $\mu$ F	
Max. permissible external inductance $L_o/L_a$ for IIB	25 mH	
Internal capacitance	1.1 nF	
Internal inductance	Negligible	
Max. voltage $U_o$ parallel	11.3 V	
Max. power $P_o$ parallel	420 mW	
Max. current $I_o$ (Ex ia) paral.	150 mA	
Internal capacitance parallel	2.2 nF	
Internal inductance parallel	negligible	
Safety-related max. voltage	253 V	
Intrinsically safe limiting values inductance $L_o$ /capacitance $C_o$	Max. connectable inductance $L_o$ /capacitance $C_o$ , 2 parallel channels	
IIC	$L_o$ [mH]	1,5 mH
	$C_o$ [ $\mu$ F]	1.790 $\mu$ F
IIB	$L_o$ [mH]	6 mH
	$C_o$ [ $\mu$ F]	12.100 $\mu$ F
IIIC	$L_o$ [mH]	6.000 mH
	$C_o$ [ $\mu$ F]	12.100 $\mu$ F

## Functional Safety

SIL	3
HFT	0
SFF	93%
Lambda SU	210 FIT
Lambda DD	0 FIT
Lambda DU	14 FIT
$PFD_{avg}$ at $T_{proof}$ 1 year	6,50E-05
$PFD_{avg}$ at $T_{proof}$ 2 years	1,24E-04
$PFD_{avg}$ at $T_{proof}$ 5 years	3,01E-04

## Electrical Data

Number of channels	2
LFD relay	Yes
Internal resistance $R_i$	150 $\Omega$

## Auxiliary Power

Auxiliary power	24 V DC
Auxiliary power voltage range	18 ... 31.2 V
Voltage range residual ripple	$\leq 3,6 V_{SS}$
Nominal current	140 mA

# Isolator Barriers

Binary output

Ex i field circuit

9175/20-12-11s Art. No. 160404



## Auxiliary Power

Power consumption	3.4 W
Max. power dissipation	2.4 W
Polarity reversal protection	Yes
Undervoltage monitoring	Yes
Operation indication	LED

## Galvanic Isolation

Test voltage as per standard	EN IEC 60079-11
Galvanic separation Ex i output to FMC	1,5 kV AC
Test voltage as per standard	EN 50178
Fault message contact to auxiliary power	350 V AC
Input to auxiliary power	350 V AC
Input to input	350 V AC
Fault message contact to input	350 V AC

## Input

Input	In accordance with EN 61131-2
Input voltage for ON	15 – 31.2 V
Input voltage for OFF	0 – 5 V
Control current	< 5 mA

## Output

Output open-circuit voltage $U_a$	10 V
Max. output current $I_{a,max}$	60 mA
Max. output current $I_a$ note	Parallel channels: 120 mA
Internal resistance $R_i$ note	150 $\Omega$ /parallel: 75 $\Omega$
Output residual ripple	< 50 mV
Output switching frequency	$\leq$ 200 Hz
Switching delay ON/OFF	$\leq$ 1 ms
Switching delay OFF/ON	$\leq$ 1 ms
Switching state indication	LED
LF switch user adjustment	Activated/deactivated
Wire break. err detection OFF	> 7 k $\Omega$ / > 3,5 k $\Omega$
Short circuit error detection output	40 ... 60 ohm $\pm$ 3 ohm/10 K
S-C para. error detection OFF	20 ... 30 ohm $\pm$ 3 ohm/10 K
Short circuit error detection note	relative to 23 °C
Test current	0.68 mA (at 7-K $\Omega$ load) 2.7 mA (at 100- $\Omega$ load)
Parallel channels test current	1.36 mA (at 7-K $\Omega$ load) 5.4 mA (at 100- $\Omega$ load)
Line fault indication	LED
Fault message contact switching capacity	30 V / 100 mA
Line fault and loss of power signalization	Contact (30 V / 100 mA) closed to ground in case of fault pac-Bus, floating contact (30 V / 100 mA)
Note	You can find a list of connectible Ex i solenoid valves on our homepage <a href="http://www.r-stahl.com">www.r-stahl.com</a> (WebCode 9175A)

# Isolator Barriers

Binary output

Ex i field circuit

9175/20-12-11s Art. No. 160404



9175/0-12-11, 9176/0-12-00 output characteristic

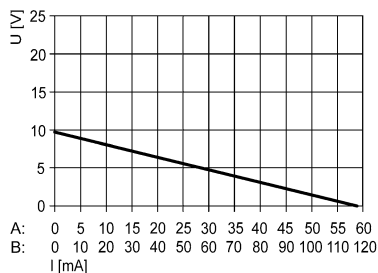

At U<sub>N</sub>: -20 to +60 °C

X axis (I [mA])

A: Characteristic curve for each channel

B: Characteristic curve for channel 1, parallel channel 2 (only types 9175/20-...-...)

## Ambient Conditions

Ambient temperature °C	-20 °C ... +70 °C (Single device) -20 °C ... +60 °C (Group assembly)
Ambient temperature °F	-4 °F ... +158 °F (Single device) -4 °F ... +140 °F (Group assembly)
Note	The installation conditions affect the ambient temperature. Observe the "Cabinet installation guide".
Storage temperature °C	-40 °C ... +80 °C
Storage temperature °F	-40 °F ... +176 °F
Max. relative humidity	95%
Use at the height of	< 2000 m
Electromagnetic compatibility	Tested to the following standards and regulations: EN 61326-1 For use in industrial areas; NAMUR NE 21

## Mechanical Data

Degree of protection (IP)	IP30
Degree of protection (IP) terminals	IP20
Fire resistance (UL 94)	V0
Enclosure material	Polyamide
Grid dimension	17.6 mm
Width	17.6 mm
Width, inches	0.69 in
Height	114.5 mm
Height in inches	4.51 in
Length	108 mm
Length in inches	4.25 in
Weight	190 g
Weight	0.42 lb

## Mounting / Installation

Mounting type	DIN rail NS35/15, NS35/7.5
Mounting orientation	Horizontal Vertical
Connection type	Screw terminal
Min. rigid conductor cross section	0.2 mm <sup>2</sup>
Max. rigid conductor cross section	2.5 mm <sup>2</sup>
Min. flex conductor cross section	0.2 mm <sup>2</sup>
Max. flex conductor cross section	2.5 mm <sup>2</sup>
Connection cross-section AWG	24 ... 14

# Isolator Barriers

Binary output

Ex i field circuit

9175/20-12-11s Art. No. 160404



## Technical Drawings – Subject to Alterations

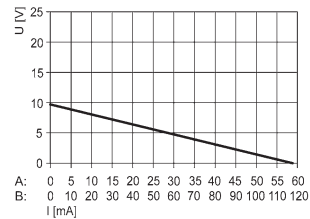

9175/0-12-11, 9176/0-12-00 output characteristic

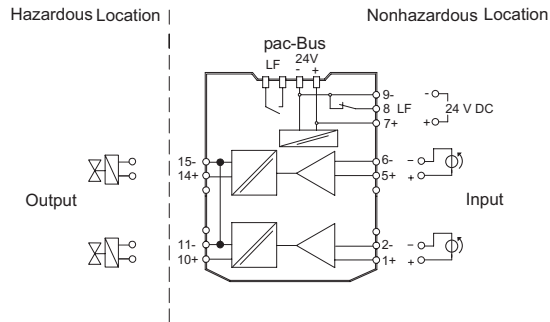

Connection Diagram 9175/20-1x-11

## Dimensional Drawings (All Dimensions in mm [inches]) – Subject to Alterations

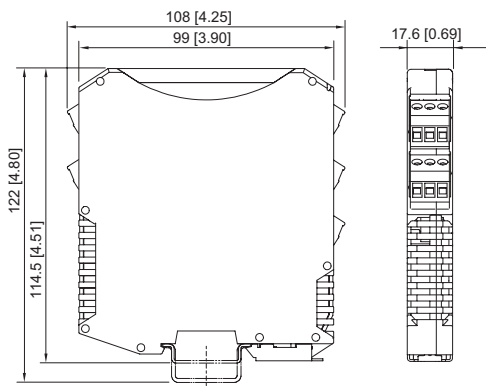

ISpac Series 9143, 9146, 9147, 9160, 9162, 9163, 9165, 9167, 9170, 9172, 9175, 9176, 9180, 9182, 9193, ISbus Series 9412 with screw terminal

## Accessories

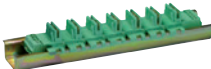
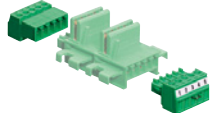
		Art. No.
<b>Transparent cover</b>		
	For 91xx ISpac modules Yellow, transparent Clear identification of the device for SIL applications. (Packaging unit: 10 pieces)	200914
<b>pac-Bus</b>		
	Wiring auxiliary power and collective error message	160731
<b>Terminal set for pac-Bus</b>		
	For the supply of 24 V DC auxiliary power via terminals (alternative to using the supply module 9193/21-11-11), with jumper for error message chain for ISpac module 91xx	160730

## Spare Parts

	Art. No.
<b>Screw terminal</b>	



# Isolator Barriers

Binary output

Ex i field circuit



9175/20-12-11s Art. No. 160404



	3-pole plug, screw connector thread: M3 stripping length: 7 mm color: green	112817
	3-pole plug, screw connector thread: M3 stripping length: 7 mm color: black	112816
	3-pole plug, screw connector thread: M3 stripping length: 7 mm color: blue	112818



## Screw terminal with test tap

Art. No.

	3-pole plug with test tap, screw connector thread: M3 stripping length: 7 mm colour: black	113005
	3-pole plug with test tap, screw connector thread: M3 stripping length: 7 mm colour: blue	113004

## Spring clamp terminal

Art. No.

	3-pole plug with test tap, spring clamp connection stripping length: 10 mm color: green	112825
	3-pole plug with test tap, spring clamp connection stripping length: 10 mm color: black	112824
	3-pole plug with test tap, spring clamp connection stripping length: 10 mm color: blue	112826

We reserve the right to make alterations to the technical data, dimensions, weights, designs and products available without notice. The illustrations cannot be considered binding.