

# Isolator Barriers

Binary output

Ex i field circuit

9175/10-16-11s Art. No. 160416



- Comprehensive portfolio to cater for all characteristics
- Two-channel variants reduce the amount of space required
- Can be used up to SIL 3 (IEC/EN 61508)
- For interface solenoid valves and LEDs

MY R. STAHL 9175A



9175 series binary outputs issue binary signals via one or two channels for the intrinsically safe operation of Ex i solenoid valves, indicator lamps or horns. The devices feature three-way galvanic separation. A wire-breakage and short-circuit monitoring system, which can be disconnected, directly monitors the state of the field circuit.

## Technical Data

Explosion Protection	
Application range (zones)	2
Ex interface zone	0, 1, 2, 20, 21, 22
IECEX gas certificate	IECEX BVS 10.0050 X
IECEX gas certificate	IECEX BVS 10.0050 X
IECEX gas explosion protection	Ex nA nC [ia Ga] IIC T4 Gc
IECEX dust certificate	IECEX BVS 10.0050 X
IECEX dust explosion protection	[Ex ia Da] IIIC
ATEX gas certificate	DMT 03 ATEX E 043 X
ATEX gas certificate	DMT 03 ATEX E 043 X
ATEX gas explosion protection	⊕ II 3 (1) G Ex nA nC [ia Ga] IIC T4 Gc
ATEX dust certificate	DMT 03 ATEX E 043 X
ATEX dust explosion protection	⊕ II (1) D [Ex ia Da] IIIC
FMus certificate	FM16US0122X
cFM certificate	FM16CA0067X
Marking cFMus	Class I, Div. 2, Groups A,B,C,D; Class I, Zone 2, Group IIC AIS Class I,II,III, Div. 1, Groups A,B,C,D,E,F,G; Class I, Zone 0, [AEx ia]/[Ex ia] IIC T4 Mounting vert. at Ta = 70°C , or horizontal Ta = 60°C See Doc. 91 756 01 31 1
cULus certificate	E81680V1S7
Marking cULus	prov. intr. safe circ. f.u.in Class I,II,III, Groups A,B,C,D,E,F,G; See Doc. 91 756 01 31 3
Certificates	ATEX (BVS), Brazil (ULB), Canada (FM), China (NEPSI), IECEX (BVS), Korea (KTL), SIL (exida), USA (FM), USA (UL)
Ship approval	CCS, EU RO MR (DNV)
Declaration of conformity	ATEX (EUK), China (CCC)

# Isolator Barriers

Binary output

Ex i field circuit

9175/10-16-11s Art. No. 160416



## Safety Data

Max. voltage $U_o/V_{oc}$	27.6 V
Max. current $I_o$ (Ex ia)	110 mA
Max. current $I_o$ (Ex ib)	50 mA
Max. power $P_o$	760 mW
Max. permissible external capacitance $C_o/C_a$ for IIC	0.085 $\mu$ F
Max. permissible external inductance $L_o/L_a$ for IIC	1.2 mH
Max. permissible external capacitance $C_o/C_a$ for IIB	0.667 $\mu$ F
Max. permissible external inductance $L_o/L_a$ for IIB	9 mH
Internal capacitance	1.1 nF
Internal inductance	Negligible
Safety-related max. voltage	253 V

## Functional Safety

SIL	3
HFT	0
SFF	94%
Lambda SU	166 FIT
Lambda DD	0 FIT
Lambda DU	9 FIT
PFD <sub>avg</sub> at T <sub>proof</sub> 1 year	4,25E-05
PFD <sub>avg</sub> at T <sub>proof</sub> 2 years	8,12E-05
PFD <sub>avg</sub> at T <sub>proof</sub> 5 years	1,97E-04

## Electrical Data

Number of channels	1
LFD relay	Yes

## Auxiliary Power

Auxiliary power	24 V DC
Auxiliary power voltage range	18 ... 31.2 V
Voltage range residual ripple	$\leq 3,6 V_{SS}$
Nominal current	80 mA
Power consumption	1.9 W
Max. power dissipation	1.4 W
Polarity reversal protection	Yes
Undervoltage monitoring	Yes
Operation indication	LED

## Galvanic Isolation

Test voltage as per standard	EN IEC 60079-11
Galvanic separation Ex i output to FMC	1,5 kV AC
Test voltage as per standard	EN 50178
Fault message contact to auxiliary power	350 V AC
Input to auxiliary power	350 V AC
Input to input	350 V AC

# Isolator Barriers

Binary output

Ex i field circuit

9175/10-16-11s Art. No. 160416



## Galvanic Isolation

Fault message contact to input 350 V AC

## Input

Input In accordance with EN 61131-2

Input voltage for ON 15 – 31.2 V

Input voltage for OFF 0 – 5 V

Control current < 5 mA

## Output

Output open-circuit voltage  $U_a$  25 V

Max. output current  $I_{a\max}$  35 mA

Output internal resistance  $R_i$  250  $\Omega$

Output residual ripple < 50 mV

Output switching frequency  $\leq$  200 Hz

Switching delay ON/OFF  $\leq$  1 ms

Switching delay OFF/ON  $\leq$  1 ms

Switching state indication LED

LF switch user adjustment Activated/deactivated

Wire break. err detection OFF > 30 k $\Omega$

Short circuit error detection output 50 ... 90 ohm  $\pm$  8 ohm/10 K

Short circuit error detection note relative to 23 °C

Test current  
0.23 mA (at 10-K $\Omega$  load)  
1.5 mA (at 100- $\Omega$  load)

Line fault indication LED

Fault message contact switching capacity 30 V / 100 mA

Line fault and loss of power signalization Contact (30 V / 100 mA) closed to ground in case of fault  
pac-Bus, floating contact (30 V / 100 mA)

Note You can find a list of connectible Ex i solenoid valves on our homepage [www.r-stahl.com](http://www.r-stahl.com) (WebCode 9175A)

9175/.0-16-11; 9176/.0-16-00 output characteristic

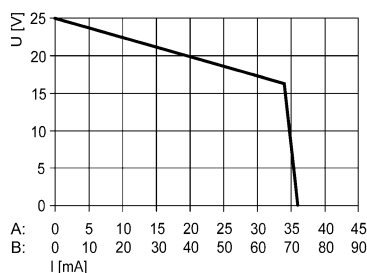

At  $U_N$ : -20 to +60 °C

X axis (I [mA])

A: Characteristic curve for each channel

B: Characteristic curve for channel 1, parallel channel 2 (only types 9175/20-...-...)

## Ambient Conditions

Ambient temperature °C  
-20 °C ... +70 °C (Single device)  
-20 °C ... +60 °C (Group assembly)

Ambient temperature °F  
-4 °F ... +158 °F (Single device)  
-4 °F ... +140 °F (Group assembly)

Note The installation conditions affect the ambient temperature. Observe the "Cabinet installation guide".

Storage temperature °C -40 °C ... +80 °C

Storage temperature °F -40 °F ... +176 °F

Max. relative humidity 95%

Use at the height of < 2000 m

# Isolator Barriers

Binary output

Ex i field circuit

9175/10-16-11s Art. No. 160416



## Ambient Conditions

Electromagnetic compatibility	Tested to the following standards and regulations: EN 61326-1 For use in industrial areas; NAMUR NE 21
-------------------------------	--

## Mechanical Data

Degree of protection (IP)	IP30
Degree of protection (IP) terminals	IP20
Fire resistance (UL 94)	V0
Enclosure material	Polyamide
Grid dimension	17.6 mm
Width	17.6 mm
Width, inches	0.69 in
Height	114.5 mm
Height in inches	4.51 in
Length	108 mm
Length in inches	4.25 in
Weight	175 g
Weight	0.39 lb

## Mounting / Installation

Mounting type	DIN rail NS35/15, NS35/7.5
Mounting orientation	Vertical Horizontal
Connection type	Screw terminal
Min. rigid conductor cross section	0.2 mm <sup>2</sup>
Max. rigid conductor cross section	2.5 mm <sup>2</sup>
Min. flex conductor cross section	0.2 mm <sup>2</sup>
Max. flex conductor cross section	2.5 mm <sup>2</sup>
Connection cross-section AWG	24 ... 14

## Technical Drawings – Subject to Alterations

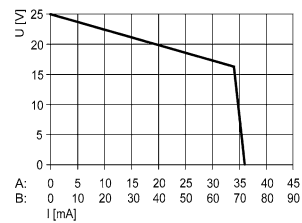

9175/0-16-11; 9176/0-16-00 output characteristic

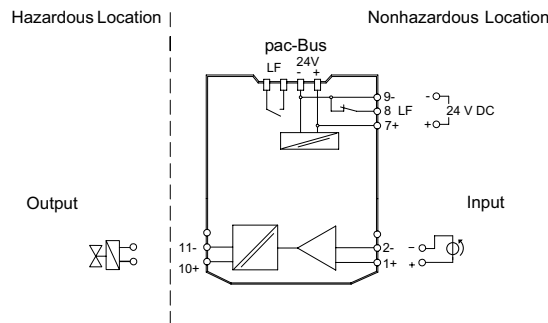

Connection diagram 9175/10-1x-11

# Isolator Barriers

Binary output

Ex i field circuit

9175/10-16-11s Art. No. 160416



## Dimensional Drawings (All Dimensions in mm [inches]) – Subject to Alterations

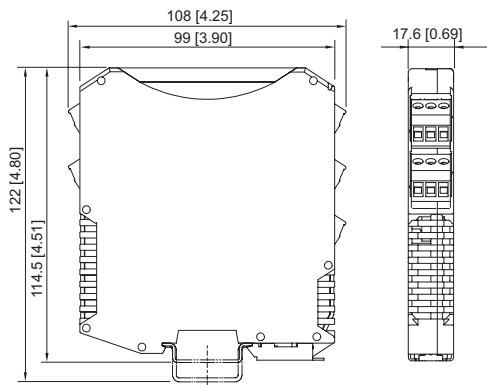

ISpac Series 9143, 9146, 9147, 9160, 9162, 9163, 9165, 9167, 9170, 9172, 9175, 9176, 9180, 9182, 9193, ISbus Series 9412 with screw terminal

## Accessories

### Transparent cover

Art. No.



For 91xx ISpac modules  
Yellow, transparent  
Clear identification of the device for SIL applications.  
(Packaging unit: 10 pieces)

200914

### pac-Bus

Art. No.

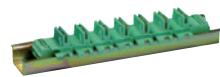

Wiring auxiliary power and collective error message

160731

### Terminal set for pac-Bus

Art. No.

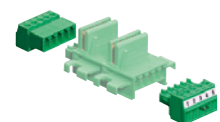

For the supply of 24 V DC auxiliary power via terminals (alternative to using the supply module 9193/21-11-11), with jumper for error message chain for ISpac module 91xx

160730

## Spare Parts

### Screw terminal

Art. No.



3-pole plug, screw connector  
thread: M3  
stripping length: 7 mm  
color: green

112817



3-pole plug, screw connector  
thread: M3  
stripping length: 7 mm  
color: black

112816



3-pole plug, screw connector  
thread: M3  
stripping length: 7 mm  
color: blue

112818

# Isolator Barriers

Binary output



Ex i field circuit

9175/10-16-11s Art. No. 160416





## Screw terminal with test tap

Art. No.

	3-pole plug with test tap, screw connector thread: M3 stripping length: 7 mm colour: black	113005
	3-pole plug with test tap, screw connector thread: M3 stripping length: 7 mm colour: blue	113004

## Spring clamp terminal

Art. No.

	3-pole plug with test tap, spring clamp connection stripping length: 10 mm color: green	112825
	3-pole plug with test tap, spring clamp connection stripping length: 10 mm color: black	112824
	3-pole plug with test tap, spring clamp connection stripping length: 10 mm color: blue	112826

We reserve the right to make alterations to the technical data, dimensions, weights, designs and products available without notice. The illustrations cannot be considered binding.