

Isolator Barriers

Vibration transducer Supply device

Ex i field circuit ISpac

9147/10-99-10s Art. No. 212432



- Space-saving two-channel variant reduces installation costs
- Easily accessible rotary switch makes adjustment simple
- Can be used up to SIL 2 (IEC 61508)

MY R. STAHL 9147A



9147 series vibration transducer power supply units connect vibration, acceleration and speed sensors to analytical systems. The measuring signals are galvanically separated when they are transmitted. They are transmitted at frequencies of up to 50 Hz. These units have already been tested with numerous sensors from well-known manufacturers such as Bently Nevada and are in use in systems across the globe.

Technical Data

Explosion Protection	
Application range (zones)	2
Ex interface zone	0, 1, 2, 20, 21, 22
IECEX gas certificate	IECEX BVS 12.0001 X
IECEX gas explosion protection	Ex ec [ia Ga] IIC T4 Gc
IECEX dust certificate	IECEX BVS 12.0001 X
IECEX dust explosion protection	[Ex ia Da] IIIC
IECEX firedamp certificate	IECEX BVS 12.0001 X
IECEX firedamp protection	[Ex ia Ma] I
ATEX gas certificate	BVS 12 ATEX E 007 X
ATEX gas explosion protection	⊕ II 3 (1) G Ex ec [ia Ga] IIC T4 Gc
ATEX dust certificate	BVS 12 ATEX E 007 X
ATEX dust explosion protection	⊕ II (1) D [Ex ia Da] IIIC
ATEX firedamp certificate	BVS 12 ATEX E 007 X
ATEX firedamp protection	⊕ I (M1) [Ex ia Ma] I
FMus certificate	FM16US0122X
cFM certificate	FM16CA0067X
Marking cFMus	Class I, Div. 2, Groups A,B,C,D; Class I, Zone 2, AEx/Ex nA Group IIC AIS Class I,II,III, Div. 1, Groups A,B,C,D,E,F,G; Class I, Zone 0, [AEx ia]/[Ex ia] IIC T4 at Ta = 70°C See Doc. 9147 6 031 001 1
Certificates	ATEX (BVS), Canada (FM), China (NEPSI), IECEX (BVS), India (PESO), Korea (KTL), SIL (exida), USA (FM)
Ship approval	CCS, EU RO MR (DNV)
Declaration of Conformity	ATEX (EUK), China (CCC)
Installation	in Zone 2

Isolator Barriers

Vibration transducer Supply device

Ex i field circuit ISpac

9147/10-99-10s Art. No. 212432



Explosion Protection

Further information	see respective certificate and operating instructions
---------------------	---

Safety Data

Max. voltage U_o/V_{oc}	26.3 V					
Max. current I_o/I_{sc}	88.3 mA					
Max. power P_o	579 mW					
Max. permissible external capacitance C_o/C_a for IIC	0.097 μ F					
Max. permissible external inductance L_o/L_a for IIC	4.4 mH					
Max. permissible external capacitance C_o/C_a for IIB	0.74 μ F					
Max. permissible external inductance L_o/L_a for IIB	18 mH					
Max. permissible external capa.IIA	2.51 μ F					
Max. permissible external inductance L_o for IIA	36 mH					
Max. permissible external capacity C_o for IIIC	0.74 μ F					
Max. permissible external inductance L_o for IIIC	18 mH					
Max. permissible external capacity C_o for I	3.95 μ F					
Max. permissible external inductance L_o for I	58 mH					
Internal capacitance	2.4 nF					
Internal inductance	Negligible					
Safety-related max. voltage	253 V					
Intrinsically safe limiting values inductance L_o /capacitance C_o	Jointly connectable inductance L_o /capacitance C_o					
IIC	L_o [mH]	2.200 mH	1 mH	0.500 mH	0.200 mH	
	C_o [μ F]	0.043 μ F	0.059 μ F	0.075 μ F	0.097 μ F	
IIB	L_o [mH]	17 mH	2 mH	0.500 mH	0.200 mH	0.10 mH
	C_o [μ F]	0.320 μ F	0.340 μ F	0.480 μ F	0.620 μ F	0.740 μ F
IIA	L_o [mH]	28 mH	1 mH	0.500 mH	0.100 mH	0.005 mH
	C_o [μ F]	0.430 μ F	0.570 μ F	0.670 μ F	1 μ F	2.510 μ F
IIIC	L_o [mH]	17 mH	2 mH	0.500 mH	0.200 mH	0.10 mH
	C_o [μ F]	0.320 μ F	0.340 μ F	0.480 μ F	0.620 μ F	0.740 μ F
I	L_o [mH]	40 mH	20 mH	1 mH	0.200 mH	0.002 mH
	C_o [μ F]	0.490 μ F	0.720 μ F	0.750 μ F	1.100 μ F	3.950 μ F

Functional Safety

SIL	2
HFT	0
SFF	66%
Lambda SD	0 FIT
Lambda SU	0 FIT
Lambda DD	188 FIT
Lambda DU	95 FIT

Isolator Barriers

Vibration transducer Supply device

Ex i field circuit ISpac

9147/10-99-10s Art. No. 212432



Functional Safety

PFD _{avg} at T _{proof} 1 year	7,95E-04
PFD _{avg} at T _{proof} 2 years	1,17E-03
PFD _{avg} at T _{proof} 5 years	2,29E-03

Electrical Data

Number of channels	1
LFD relay	No
Operation indication	Green "PWR" LED
Internal resistance R _i	30 Ω

Auxiliary Power

Auxiliary power	24 V DC
Nominal voltage V _{nom}	24 V DC
Auxiliary power voltage range	18 to 31.2 V
Voltage range residual ripple	≤ 3,6 V _{SS}
Nominal current	75 mA
Power consumption	1.8 VA
Max. power dissipation	1.4 W
Polarity reversal protection	Yes
Undervoltage monitoring	Yes
Operation indication	Green "PWR" LED

Galvanic Isolation

Test voltage as per standard	EN IEC 60079-11
Ex i input to output	1.5 kV AC
Ex i input to auxiliary power	1.5 kV AC
Test voltage as per standard	EN 50178
Output to auxiliary power	350 V AC

Input

Input	-20 to -0.5 V
Input signal	-20 to -0.5 V
Function range input	-24 – 0 V
Input resistance	10 kΩ
Output current for 2-wire operation	2.6/4.3/7.9 mA at -10 V
Output current for 3-wire operation	10 mA at -20 V; 20 mA at -17 V

Output

Output	-20 to -0.5 V
Output signal	-20 to -0.5 V
Output internal resistance R _i	30 Ω
Load resistance R _L	> 2 kΩ
Signal transmission delay	< 7 μs
Signal transmission frequency range	0 – 50 kHz
Signal transmission phase fluctuation	< 0.6%/period
Deviations / error note	Information in % of the measuring range (20 mA) at U _N , 23 °C
Temperature influence error limits	< 0.05% / 10 K
Auxiliary power influence error limits	< 0,05 %

Isolator Barriers

Vibration transducer Supply device

Ex i field circuit ISpac

9147/10-99-10s Art. No. 212432



AC transmission error at U_N and 20 °C and an offset of 10 V	Frequency	Phase error	Amplitude error
	0 to 200 Hz	$\leq 0.5^\circ$	$\pm 1\%$
	< 400 Hz	$\leq 1.0^\circ$	$\pm 1\%$
	< 600 Hz	$\leq 1.5^\circ$	$\pm 1\%$
	< 1 Hz	$\leq 2.5^\circ$	$\pm 1\%$
	< 10 kHz	$\leq 25^\circ$	+1/-5%
	< 20 kHz	$\leq 50^\circ$	1/5%
	< 50 kHz	$\leq 125^\circ$	-1%

Ambient Conditions

Ambient temperature °C	-20 °C ... +70 °C (Single device) -20 °C ... +60 °C (Group assembly)
Ambient temperature °F	-4°F ... +158°F (Single device) -4°F ... +140°F (Group assembly)
Note	The installation conditions affect the ambient temperature. Observe the "Cabinet installation guide".
Storage temperature °C	-40 °C ... +80 °C
Storage temperature °F	-40°F ... +176°F
Max. relative humidity	95%
Use at the height of	< 2000 m
Electromagnetic compatibility	Tested to the following standards and regulations: EN 61326-1 For use in industrial areas; NAMUR NE 21

Mechanical Data

Degree of protection (IP)	IP30
Degree of protection (IP) terminals	IP20
Fire resistance (UL 94)	V0
Enclosure material	Polyamide
Grid dimension	17.6 mm
Width	17.6 mm
Width, inches	0.69 in
Height	114.5 mm
Height in inches	4.51 in
Length	108 mm
Length in inches	4.25 in
Mounting depth in inches	4.51 in
Weight	150 g
Weight	0.33 lb

Mounting / Installation

Mounting type	DIN rail NS35/15, NS35/7.5
Mounting orientation	Vertical Horizontal
Connection type	Screw terminal
Min. rigid conductor cross section	0.2 mm ²
Max. rigid conductor cross section	2.5 mm ²
Min. flex conductor cross section	0.2 mm ²
Max. flex conductor cross section	2.5 mm ²
Connection cross-section AWG	24 ... 14

Isolator Barriers

Vibration transducer Supply device

Ex i field circuit ISpac

9147/10-99-10s Art. No. 212432



Technical Drawings – Subject to Alterations

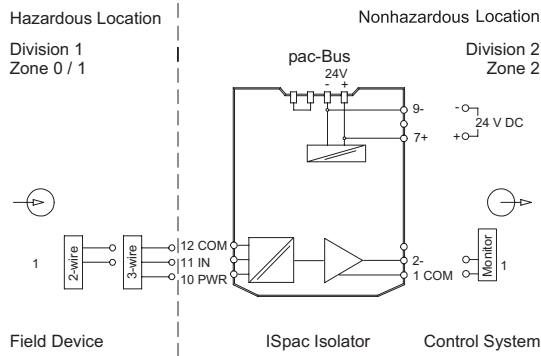

Connection diagram 9147/10-99-10

Dimensional Drawings (All Dimensions in mm [inches]) – Subject to Alterations

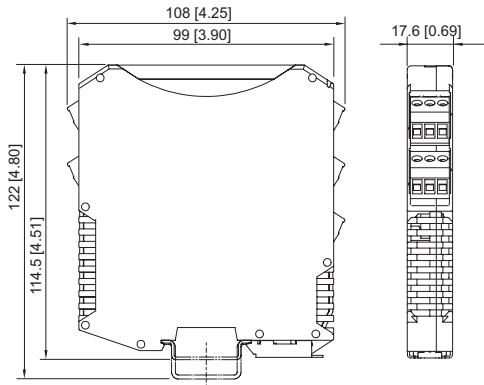

ISpac Series 9143, 9146, 9147, 9160, 9162, 9163, 9165, 9167, 9170, 9172, 9175, 9176, 9180, 9182, 9193, ISbus Series 9412 with screw terminal

Accessories

Transparent cover

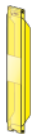

For 91xx ISpac modules
Yellow, transparent
Clear identification of the device for SIL applications.
(Packaging unit: 10 pieces)

Art. No.

200914

Spare Parts

Screw terminal



3-pole plug, screw connector
thread: M3
stripping length: 7 mm
color: green

Art. No.

112817



3-pole plug, screw connector
thread: M3
stripping length: 7 mm
color: black

Art. No.

112816





Isolator Barriers

Vibration transducer Supply device

Ex i field circuit ISpac

9147/10-99-10s Art. No. 212432



	3-pole plug, screw connector thread: M3 stripping length: 7 mm color: blue	112818
Screw terminal with test tap		Art. No.
	3-pole plug with test tap, screw connector thread: M3 stripping length: 7 mm colour: black	113005
	3-pole plug with test tap, screw connector thread: M3 stripping length: 7 mm colour: blue	113004
Spring clamp terminal		Art. No.
	3-pole plug with test tap, spring clamp connection stripping length: 10 mm color: green	112825
	3-pole plug with test tap, spring clamp connection stripping length: 10 mm color: black	112824
	3-pole plug with test tap, spring clamp connection stripping length: 10 mm color: blue	112826

We reserve the right to make alterations to the technical data, dimensions, weights, designs and products available without notice. The illustrations cannot be considered binding.