

Remote I/O

IS1+ Remote I/O Digital output module

For Zone 1 Ex i

9475/32-04-72 Art. No. 218063



- Four channels for Ex i hydraulic and solenoid valves up to 95 mA
- Ex ib outputs with line fault monitoring and LED error and status indication for each channel plus SIL 2 shutdown input
- Modules in Zone 1, Cl. I, II, Div. 2 can be hot swapped

MY R. STAHL 9475F



9475/32-04-72 series digital output modules for Zone 1, Cl. I, II, Div. 2 have four channels for actuating Ex i hydraulic and solenoid valves or indicator lamps. An additional Ex i control input is suitable for safe shutdown up to SIL 2. All outputs are short-circuit proof, galvanically separated from the system and individually monitored to check for wire breakage/short-circuiting.

Technical Data

Explosion Protection

Application range (zones)	1, 2
Ex interface zone	1, 2, 21, 22
IECEX gas certificate	IECEX DEK 12.0070X
IECEX gas explosion protection	Ex ia [ib Gb] IIC T4 Gb
IECEX dust certificate	IECEX DEK 12.0070X
IECEX dust explosion protection	[Ex ib Db] IIIC
ATEX gas certificate	DEKRA 12 ATEX0232X
ATEX gas explosion protection	Ex II 2 (2) G Ex ia [ib Gb] IIC T4 Gb
ATEX dust certificate	DEKRA 12 ATEX0232X
ATEX dust explosion protection	Ex II (2) D [Ex ib Db] IIIC
FMus certificate	FM17US0332X
cFM certificate	FM16CA0134X
Marking cFMus	IS, Class I, Div. 2, Groups A,B,C,D; Class I, Zone 1, AEx/Ex ia [ib] IIC NIFW Class I,II,III, Div. 2, Groups A,B,C,D,E,F,G; T4 at Ta = 75°C See Doc. 9475 6 031 005 1
Certificates	ATEX (DEK), Brazil (ULB), Canada (FM), China (NEPSI), IECEX (DEK), India (PESO), Korea (KTL), SIL (exida), USA (FM)
Ship approval	ABS, BVIS, EU RO MR (DNV), KR, LR
Declaration of Conformity	ATEX (EUK), China (CCC)
Installation	Zone 1, Zone 2, Zone 21, Zone 22, Cl. I, II, Div. 2 and in the safe area
Further information	see respective certificate and operating instructions

Safety Data

Max. voltage U_o/V_{oc}	15.4 V
Max. current I_o (Ex ia)	0 mA
Max. power P_o (Ex ia)	0 mW
Max. current I_o (Ex ib)	115.4 mA

Remote I/O

IS1+ Remote I/O Digital output module

For Zone 1 Ex i

9475/32-04-72 Art. No. 218063



Safety Data

Max. power P_o (Ex ib)	1475 mW						
Internal inductance	Negligible						
Max. internal capacitance C_i	33 nF (in the following tables, C_i has been subtracted from C_o)						
Max. connectable inductance L_o /capacitance C_o							
IIC	L_o [mH]	0.11	0.1	0.05	0.02	0.01	
	C_o [nF]	257	267	337	477	488	
	L_o [mH]	for ≤ 700 m conductor ($\leq 1 \mu\text{H/m}$; $\leq 200 \text{ pF/m}$; $10.76 \text{ m}\Omega/\text{m}$)					
	C_o [nF]	0.05					
IIB/IIIC	L_o [mH]	2.9	2.0	1.0	0.5	0.05	0.02
	C_o [nF]	1467	1767	2367	2667	2767	3157
	L_o [mH]	for ≤ 2000 m conductor ($\leq 1 \mu\text{H/m}$; $\leq 200 \text{ pF/m}$; $10.76 \text{ m}\Omega/\text{m}$)					
	C_o [nF]	2.0	1.0	0.5	0.002		
	C_o [nF]	1667	2367	2667	3967		
Ex i control input "Plant STOP"							
Connection terminals	X3 1, 2 (without galvanic separation, compatible with 9575/22)					X3 3, 4 (with galvanic separation, switchable in parallel)	
Type of protection	Ex ia					Ex ia	
Max. voltage U_o	5.1 V					--	
Max. current I_o	0.44 mA					--	
Max. power P_o	0.5 mW					--	
Max. connectable inductance L_o /capacitance C_o							
IIC	L_o [mH]	100	10	2	1	0.2	0.01
	C_o [nF]	2.195	2.595	3.295	3.695	5.495	15.995
IIB/IIIC	L_o [mH]	100	10	2	1	0.2	0.01
	C_o [nF]	9.995	12.995	16.995	19.995	31.995	--
Max. voltage U_i	--					30 V	
Max. internal resistance R_i	--					4940 Ω	
Max. internal capacitance C_i	5.2 nF (in the tables above, C_i has been subtracted from C_o)					Negligible	
Max. internal inductance L_i	Negligible					Negligible	
Electrical Data							
Number of channels	4 (3) Ex i inputs (depends on nominal output current)						
Connection Ex i field signals	Pluggable, blue terminals, 16-pin, 2.5 mm ² , screw or cage clamp version with lock						
Connection Ex i Steuereingang	Pluggable, blue terminals, 2-pin, 2.5 mm ² , screw type version with lock						

Remote I/O

IS1+ Remote I/O Digital output module

For Zone 1 Ex i

9475/32-04-72 Art. No. 218063



Ex i X3 control input Connection terminals		X3 1, 2 (without galvanic separation, compatible with 9575/22)	X3 3, 4 (with galvanic separation, switchable in parallel)
	Supply voltage	3.3 V	--
	Internal resistance	20.5 kΩ	--
	Control voltage for all outputs "OFF" ("Plant STOP" activated)	> 2.2 V	< 1 V
	"Normal operation" ("Plant STOP" deactivated)	< 0.7 V	> 6 V

Auxiliary Power

Power supply connection	BusRail types 9494
Auxiliary power version	Intrinsically safe Ex ia via BusRail
Behaviour during undervoltage	All outputs "OFF"
Current consumption	250 mA
Max. power consumption	6 W
Max. power dissipation outputs	5.8 W
Max. power dissipation rated operational current	3.4 W

Galvanic Isolation

Test voltage for galvanic separation	Acc. to standard EN 60079-11
Auxiliary power/system components	≥ 1500 V AC
I/O module / I/O module	≥ 500 V AC
I/O channels/system components	≥ 500 V AC
I/O channels / ground (PA)	≥ 500 V AC
I/O channels/plant STOP X3 3,4	≥ 500 V AC
Plant STOP X3 3,4/earth (PA)	≥ 500 V AC

Input

Control input	Ex i control input X3
Control input suitability	Shutdown up to SIL 2, low demand (IEC 61508)
Control input function	"Plant STOP" for switching off all outputs

Output

Ex i output rated operation	12.3 V/75 mA 11.7 V/95 mA
Internal resistance of outputs	23.2 Ω
Open-circuit voltage U_o	13.8 V

¹⁾ 4 channels

²⁾ max. 3 channels

Output characteristic 9475/32-04-72

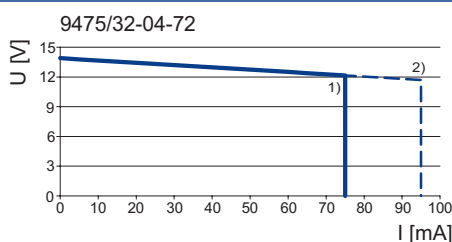

¹⁾ 4 channels

²⁾ Max. 3 channels

Note: During operation with four outputs and a total current > 320 mA, output 4 is pulsed. Reduce the load current to < 320 mA.

Remote I/O

IS1+ Remote I/O Digital output module

For Zone 1 Ex i

9475/32-04-72 Art. No. 218063



Device Specific Data

Diagnostics message module	ON OFF
Line fault monitoring	OFF ON ON without test current
Test current signal	0,54 ... 0,66 mA
Output behaviour in case of error	OFF ON Keep last value
LED module requires maintenance	"M/S" LED, blue
LED operating conditions	"RUN" LED, green
LED channel error	LED for each channel, red
LED channel status	LED per channel, yellow
"Plant STOP" LED	"Plant STOP" LED, yellow (all outputs are high-impedance)
Retrievable parameters	Type Software revision Hardware revision Manufacturer Serial number
Signal status bit	"1" = Output supplied with power "0" = High-impedance output
Wire breakage output	> 1 k Ω (response range 1 ... 5 k Ω) (with deactivated test current can be detected only if the output is switched on)
Short circuit output	< 30 Ω (response range 30 ... 70 Ω) (can be detected only if the output is switched on)

Diagnostics

LED group error	"ERR" LED, red
-----------------	----------------

Ambient Conditions

Ambient temperature °C	-40°C ... +75°C
Ambient temperature °F	-40°F ... +167°F
Storage temperature °C	-40°C ... +80°C
Storage temperature °F	-40°F ... +176°F
Max. operating altitude	< 2000 m
Max. relative humidity	95% (without condensation)
Shock (semi-sinusoidal)	(IEC EN 60068-2-27) 15 g (3 shocks per axis and direction)
Vibration (sinusoidal)	(IEC EN 60068-2-6) Frequency range 2 ... 13.2 Hz Amplitude 1 mm (peak value) Frequency range 13.2 ... 100 Hz Acceleration amplitude 0.7 g
Electromagnetic compatibility	Tested to the following standards and regulations: EN 61326-1 (2006) IEC 61000-4-1 to 61000-4-6, NAMUR NE 21
Note	(observe operating instructions)

Mechanical Data

Degree of protection (IP) (IEC 60529)	IP20
Module enclosure	Polyamide 6GF
Fire resistance (UL 94)	V2
Pollutant class	Corresponds to G3
Width	96.5 mm

Remote I/O

IS1+ Remote I/O Digital output module

For Zone 1 Ex i

9475/32-04-72 Art. No. 218063



Mechanical Data

Width, inches	3.8 in
Height	67 mm
Length	128 mm
Length in inches	5.04 in
Mounting depth in inches	2.64 in
Weight	275 g
Weight	0.61 lb

Mounting / Installation

Mounting type	on NS 35/15 DIN rail (DIN EN 60715)
Mounting orientation	Vertical Horizontal

Technical Drawings – Subject to Alterations

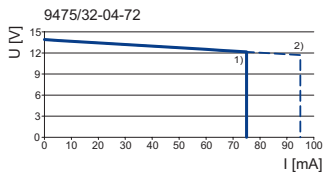

¹⁾ 4 channels

²⁾ max. 3 channels

Output characteristic 9475/32-04-72

Dimensional Drawings (All Dimensions in mm [inches]) – Subject to Alterations

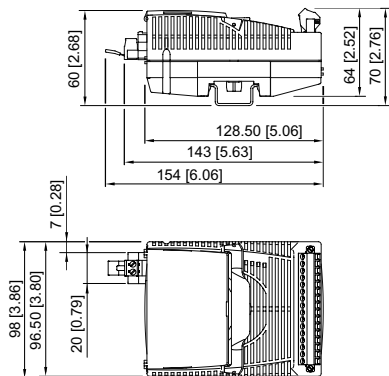

Accessories

Pluggable terminal		Art. No.
	2.5 mm ² with lock, 16-pin, screw connector, blue, for connecting the field signals to I/O modules, for intrinsically safe field circuits Labelling: 1 to 16 Note: A second terminal is additionally required for I/O module Series 9470 and 9482 Labelling: 17 to 32	162702
	2.5 mm ² with lock, 16-pin, spring clamp connection, blue, for connecting the field signals to I/O modules, for intrinsically safe field circuits, incl. test jacks Labelling: 1 to 16 Note: A second terminal is additionally required for I/O module Series 9470 and 9482 Labelling: 17 to 32	162695





Remote I/O

IS1+ Remote I/O Digital output module

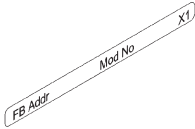

For Zone 1 Ex i

9475/32-04-72 Art. No. 218063



Partition		Art. No.
	For mounting between intrinsically safe and non-intrinsically safe connections between I/O modules to maintain a tight string length of 50 mm	220101
Warning label		Art. No.
	"Clean modules only with a damp cloth."	162796
DIN A4 sheet		Art. No.
	For label plate on I/O modules; 6 plates per sheet; IS Wizard printout; packaging unit = 20 sheets	162832
Labelling strips		Art. No.
	"FB Addr ... Mod No ..." for pluggable terminal, 26 pieces on the sheet	162788
Vibration bracket set		Art. No.
	When installed in environments with extreme vibration (> 0.7 g and max. 4 g), the 9490 vibration brackets may be used as an additional measure and provide mechanical stability for the individual modules. For mounting: All I/O modules, except 9477/12 and 9478 Number of brackets in a set: 8 Screws (item no. 275516) must be ordered separately.	271920
Set of screws		Art. No.
	Set of M5 x 14 screws (self-tapping) for 9490 vibration brackets Number of screws in a set: 25	275516

Spare Parts

Ex i LED indicator lamp		Art. No.
	8010/3-02 LED indicator lamp for intrinsically safe circuits, Ex i	237972
LED indicator lamp for front installation		Art. No.
	for Ex i front installation	240901

We reserve the right to make alterations to the technical data, dimensions, weights, designs and products available without notice. The illustrations cannot be considered binding.