

8595/1-CB1-S-P05-00E Art. No. 298989



- Simple handling using hot swap technology
- Versatile application possibilities thanks to modular structure
- Most extreme operating conditions in hazardous areas
- Reliable data and signal connections or power supplies
- Simple connection and disconnection thanks to one-handed operation

MY R. STAHL 8595F



R. STAHL's Series 8595/1 explosion-protected miniCON plug connectors with up to eight poles keep you safely connected. The high-quality plastic or stainless steel plug connectors have impressed many customers with their reliability and versatility in application. Their hot swap disconnecting capacity means that intrinsically safe signal supplies and power supplies up to 500 V/16 A can be connected and disconnected reliably and safely without the need for a hot work permit or other hot work authorisation. The miniCON connectors designed for conductor cross-sections of 0.25 mm² to 2.5 mm² are available for directly connecting electrical lines or for device installation in the device plug and flange socket types of construction. The new plug connectors for hazardous areas in Zones 1 and 21 stand out from the competition thanks to their modular structure and logically arranged components, which enable quick, easy mounting. Our patented single-handed operation means that matching plug connectors, which can be defined by the installer using internal coding for up to three applications, can be connected in no time.

Technical Data

Explosion Protection

Area of application	European Union (ATEX) IECEX
Application range (zones)	1, 2, 21, 22
IECEX gas certificate	IECEX EPS 20.0035X
IECEX gas certificate	IECEX EPS 20.0035X
IECEX gas explosion protection	Ex db eb IIC T6 / T5 Gb
IECEX gas explosion protection 2	Ex ia IIC T6 Ga
IECEX dust certificate	IECEX EPS 20.0035X
IECEX dust explosion protection	Ex tb IIIC T80 °C / T95 °C Db
IECEX dust explosion protection 2	Ex ia IIIC T80 °C Da
ATEX gas certificate	EPS 20 ATEX 1075 X
ATEX gas certificate	EPS 20 ATEX 1075 X
ATEX gas explosion protection	⊕ II 2 G Ex db eb IIC T6 / T5 Gb
ATEX gas explosion protection 2	⊕ II 1 G Ex ia IIC T6 Ga
ATEX dust certificate	EPS 20 ATEX 1075 X
ATEX dust explosion protection	⊕ II 2 D Ex tb IIIC T80 °C / T95 °C Db
ATEX dust explosion protection 2	⊕ II 1 D Ex ia IIIC T80 °C Da
Certificates	ATEX (EPS), IECEX (EPS)
Declaration of Conformity	ATEX (EUK)

Installation equipment

miniCON plug connector



8595/1-CB1-S-P05-00E Art. No. 298989

Electrical Data

Rated operational voltage AC	500 V
Rated operational voltage DC	max. 110 V
Voltage tolerance	+10%
Rated insulation voltage	690 V
Rated operational current for AC	16 A
Rated operational current for DC	8 A
Rated operational current for DC 2	16 A
No. of poles	7
No. of poles	7 P + PE / 8 P
AC frequency range	50 – 60 Hz

Device Specific Data

Back-up fuse with thermal protection	25 A GL
Back-up fuse without thermal protection	16 A GL

Ambient Conditions

Ambient temperature °C	-60 °C ... +75 °C
Ambient temperature °F	-76 °F ... +167 °F

Mechanical Data

Version	Ex e flange socket, reverse
Degree of protection (IP) (IEC 60529)	IP66 IP67
IP degree of protection (IEC 60079)	IP64
Base part	Coupling
Enclosure material	Nickel-plated brass
Contact type	Pin contact
Connection cross-section	0.5 mm ²
Connection cross-section 2	0.25 mm ²
Connection cross-section AWG	20 AWG
Connection cross-section AWG	24 AWG
Connection cross-section 2 min.	0.25 mm ²
Connection cross-section 2 max.	0.25 mm ²
Connection cross-section 2 AWG min.	24 AWG
Connection cross-section 2 AWG max.	24 AWG
Connection thread	M32 x 1.5
Impact strength (IEC 60079)	7 J
Coding	1-3, arbitrary
Seal	Silicone
Weight	400 g
Weight	0.88 lb

Mounting / Installation

Connection type	crimp
Connection type 2	solder

Components

Protective cap available	Yes
--------------------------	-----

Technical Drawings – Subject to Alterations

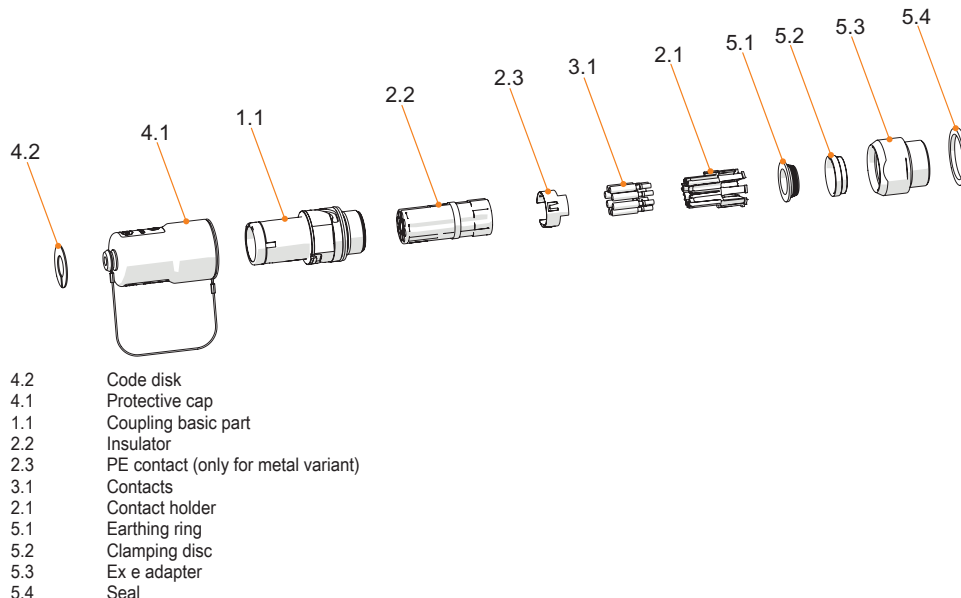
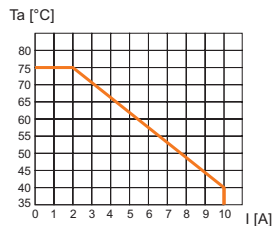

Dimensional Drawings (All Dimensions in mm [inches]) – Subject to Alterations

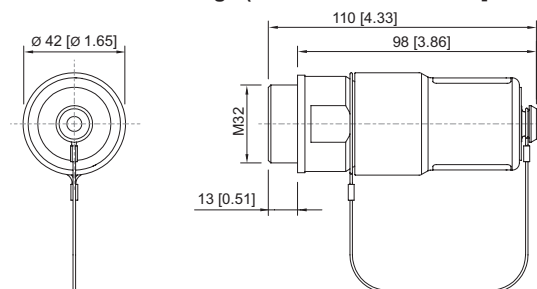

8595/1 bulkhead receptacle

Accessories

EMC/shielding		Art. No.
	To create an EMC-compliant connection of braided, shielded or reinforced conductors.	307512
Ex e device plug, reverse		Art. No.
	Enclosure material: Nickel-plated brass Contact type: Socket contact Connection cross-section: 0.5 mm ² Number of poles: 7 P + PE/8 P Connection type: Crimping	298953
Crimping tool		Art. No.
	For all versions with crimp connection of 0.14 to 6 mm ²	295689

8595/1-CB1-S-P05-00E Art. No. 298989

Contact mounts/positioners for rotated industrial contacts

Art. No.

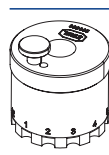
	<p>The selection of the contact mount is based on the crimp contacts to be processed.</p> <ul style="list-style-type: none"> - Exact positioning of the crimp contact during the crimping process - Reliable, reproducible crimping result - Adapted for miniCON contacts 	<p>299586</p>
--	--	---------------

Adaptor

Art. No.

	<p>KIT 8595 nickel-plated brass adaptor, M20 x 1.5, for installation in Ex e enclosure</p>	<p>304566</p>
	<p>KIT 8595 nickel-plated brass adaptor, M25 x 1.5, for installation in Ex e enclosure</p>	<p>304568</p>
	<p>KIT 8595 nickel-plated brass adaptor, M32 x 1.5, for installation in Ex e enclosure</p>	<p>296754</p>

Pin contact

Art. No.

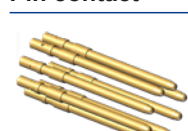
	<p>KIT 8595 pin contacts (0.25 to 0.5 mm²), 8 pieces</p>	<p>286155</p>
--	---	---------------

Code disks

Art. No.

	<p>KIT coding plate 8595, four colours, without labelling Customer-specific labelling available on request</p>	<p>289939</p>
--	--	---------------

Reducer

Art. No.

	<p>CMP-737DR Reducer M32 x 1.5 - M20 x 1.5 Brass</p>	<p>281582</p>
	<p>CMP-737DR Reducer M32 x 1.5 - M25 x 1.5 Brass</p>	<p>281584</p>

Spare Parts

Jam nut, nickel-plated brass

Art. No.

	<p>Material: Nickel-plated brass One piece Thread size: M32</p>	<p>110869</p>
--	--	---------------

Contact holder for pin contact

Art. No.

	<p>KIT 8595 pin contact insert + PE</p>	<p>286148</p>
--	---	---------------

Protective cap

Art. No.

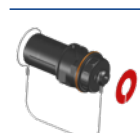
	<p>KIT 8595 coupling protective cap (pin) Incl. KIT 8595 coding plates, four colours, without labelling</p>	<p>286160</p>
--	---	---------------

Installation equipment

miniCON plug connector



8595/1-CB1-S-P05-00E Art. No. 298989

We reserve the right to make alterations to the technical data, dimensions, weights, designs and products available without notice. The illustrations cannot be considered binding.