

8568/MCCB-GS102B-70 Art. No. 240697



- Degree of protection: Explosion-protected 1- and 2-pole moulded case circuit breaker with thermomagnetic protection
- Rated operational current from 15 to 125 A
- Maximum rated operational voltage: IEC/ATEX up to 415 V AC and NEC/CE Code up to 480 V AC
- Rated switching capacity of 10 kA according to IEC/EN 60947/UL 489
- Isolating characteristics according to IEC/EN 60947-2
- Thermal and magnetic release permanently set
- Design according to UL 489/CSA-C22.2 No. 5 and IEC 60947-2

MY R. STAHL 8568A



The Series 8568 moulded case circuit breakers meets all of the technical requirements for safe and selective switching-off. In the event of a short circuit, they limit the energy in the connected electrical circuits due to their mode of operation which effectively restricts short-circuit current, and thanks to their high short-circuit strength. They therefore provide a high degree of protection against back-up fuses tripping.

Technical Data

Explosion Protection

Application range (zones)	1, 2, 21, 22
Application range (Zone) note	For use in Zone 21/22 when protected by Ex tb/tc enclosure
IECEx gas certificate	FMG16.0005X
IECEx gas explosion protection	Ex db eb IIC T4 / T5 Gb
ATEX gas certificate	FM 16 ATEX 0005X
ATEX gas explosion protection	Ⓔ II 2 G Ex db eb IIC T4 / T5 Gb
FMus certificate	FM19US0099U
cFM certificate	FM19CA0049U
Marking FMus	Class I, Div. 2, Groups A,B,C,D; T6 ... T4; Class I, Zone 1, AEx db eb IIC T6 ... T4
Marking cFM	Class I, Zone 1, Ex db eb IIC T6 ... T4 Class I, Div. 2, Groups A,B,C,D; T6 ... T4;
Certificates	ATEX (FM), Canada (FM), IECEx (FM), USA (FM)

Electrical Data

Rated operational voltage AC	240 V / 415 V
AC rated operat. voltage (NEC)	480 V
Rated operational voltage DC	125 V / 250 V
Rated operational voltage DC (NEC)	125 V / 250 V
Rated operational current	70 A
Rated operational current	70 A
Rated interrupting capacity	10 kA
Type of voltage	AC/DC
Auxiliary contacts	without
Auxiliary contacts 2	without
N-pole present	No
No. of poles	2

Components for system solutions

Compact molded case circuit breaker



8568/MCCB-GS102B-70 Art. No. 240697

Ambient Conditions

Ambient temperature °C	-30 °C ... 40 °C (T5) -30 °C ... 60 °C (T4)
Ambient temperature °F	-22 °F ... 104 ... +104 °F (T5) -22 °F ... +140 °F (T4)
Note	Ambient temperature range for the device's installation location. If the device is installed at temperatures reaching +60 °C (+140 °F), please contact the factory.

Mechanical Data

Degree of protection (IP)	IP20
Enclosure material	Epoxy resin
Connection cross-section AWG	2 AWG ... 4/0 AWG
Min. tightening torque	15 Nm
Max. tightening torque	20 Nm
Connection cross-section	35 ... 95 mm ²
Width	89.2 mm
Length	286 mm
Length in inches	11.26 in
Depth of cut-out	144 mm
Mounting depth in inches	5.67 in
Weight	7.5 lb

Mounting / Installation

Tightening torque	15 – 20 Nm
Tightening torque lbf in	132 to 177 lbf in

Dimensional Drawings (All Dimensions in mm [inches]) – Subject to Alterations

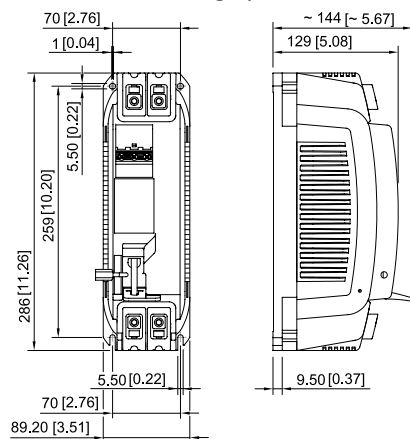

8568/MCCB, 2-pole

We reserve the right to make alterations to the technical data, dimensions, weights, designs and products available without notice. The illustrations cannot be considered binding.